

# INDIGO

LIGHTING

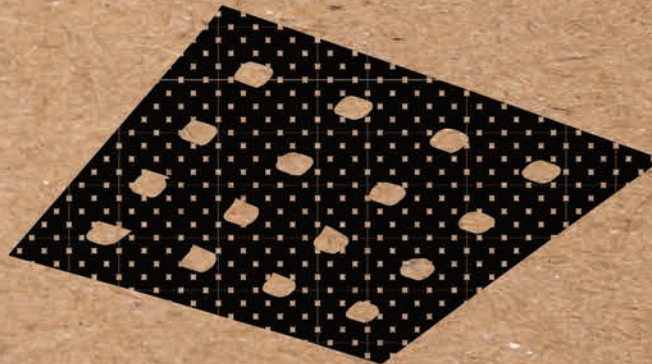

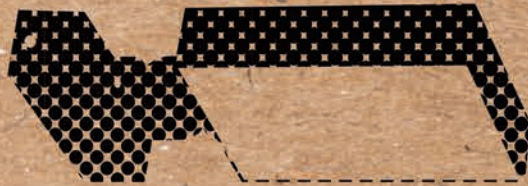
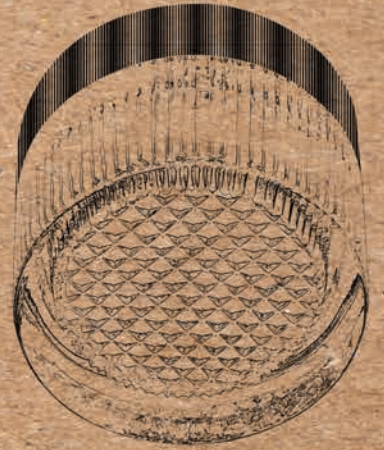
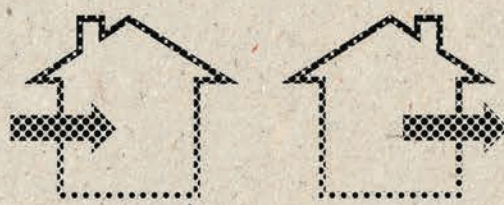

# INDIGO

---

## LIGHTING

**INDIGO S. A.**

Parc Artisanal de Cornemont  
Rue de la Légende 32G  
4141 Sprimont  
BELGIQUE

T : +32 (0)4 351 91 40  
F : +32 (0)4 351 91 41  
info@indigo-lighting.com

[indigo-lighting.com](http://indigo-lighting.com)



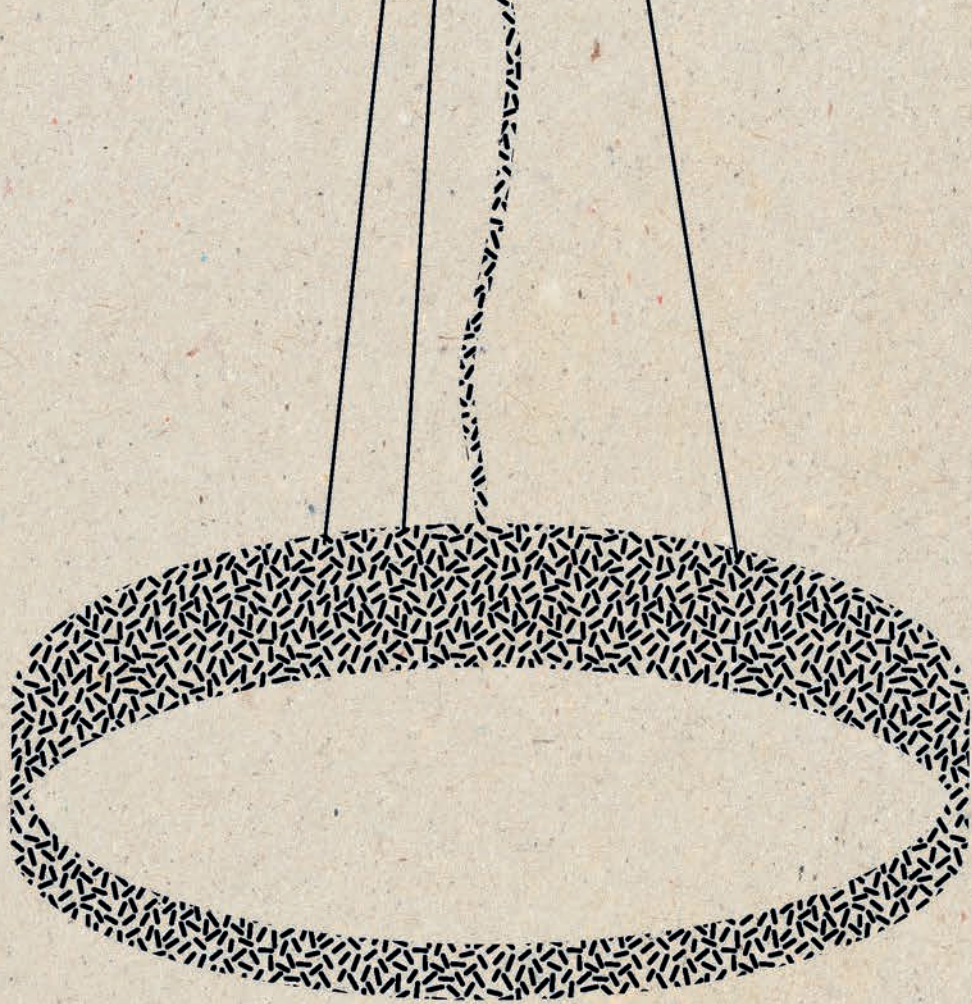

INTÉRIEUR



EXTÉRIEUR



ACCESSOIRES



**NOUVEAUTÉS**



BASIL 1 P	436	LINEAR 2 P	361
BASIL 2 P	436	ML01	484
BASIL 3 P	437	ML02	484
BOL201	479	NOVA CSP 1 C	228
BRAVA RD 230	48	NOVA CSP 1 P	250
BRAVA RDH 230	49	NOVA CSP 2 C	228
BRIKPRO 1	528	NOVA CSP 2 P	250
BRIKPRO 1 A	530	NOVA CSP 3 C	229
BRIKPRO 2	528	NOVA CSP 3 P	251
BRIKPRO 2 A	530	OSIS 1 PLUS	317
C100924	634	OSIS 2 PLUS	318
CD173	624	PLANK 1	188
CD174	624	PLANK 2	188
CD175	624	PLDUNIDRIVE350MA	622
CD176	624	PLDUNIDRIVE700MA	622
CD177	624	PLR35015	622
CD178	624	PLU35019	622
CD179	624	PLU70039	622
CD180	624	PLUPP35019	622
CD181	624	POLARIS	376
CF505RGBW	640	PSDAL350M	623
CR575RGBW	641	PSDAL700M	623
DOMINO CSP	148	PSDIM350	622
DOMINO	148	PSDIM700	622
EAZY	384	PSIP35018W	622
EVIA G9	160	PSIP3509W	622
GL008 RGBW	424	PSIP70018W	622
GL016	413	PSIP70036W	622
GL016 F	415	PSMD3501324	623
GL016 RGBW	428	PSMD35039	623
GL016 SQ	414	PSMD70024	623
GL018 C	422	PSMD700610	623
GL018 SQ	423	RAYPRO 14	580
GL019	409	RAYPRO 32	581
GL019 E	488	RAYPRO 32 A	581
GL019 F	411	RAYPRO 50	582
GL019 LG	410	RAYPRO 50 A	582
GL019 SQ	412	SL030	446
GL019 ULG	410	SL040A	455
GL021	486	SL220	448
GL022	487	SL220 MAINS	449
GL034	489	SL230	450
GL038	408	SL230 MAINS	451
GL040	406	SL240	452
GL040 CA RGB	427	SL240 MAINS	453
GL040 ULG	407	SL250	454
GL045	405	SOLIS 1	144
GL050	420	SOLIS 2	145
GL050 RGBW	429	SOLIS 3	145
GL06	405	SOLIS IP65	146
GL063	416	SOLIS PRO CSP	147
GL064	417	SOLIS PRO	146
GL07	404	SPIRA 1 RX PLUS	138
GL08	403	SPRINGBOK LITE 1	381
GL09	402	SPRINGBOK LITE 2	382
GL090 RGBW	426	SPRINGBOK LITE 3	383
GL100	418	THEALITE CSP 1	122
GL200	419	THEALITE CSP 2	123
H2 LITE CSP	51	THEALITE CSP 3	123
H2 LITE SELECT	50	THEA PRO 1	129
INDY 1	577	THEA PRO 2	128
INDY 1 A	576	UL010	518
INDY 2	578	UL010 RGBW	519
INDY 2 A	578	UL030	520
JB1	644	UL030 RGBW	521
JB2	645	ULCARGB	592
JB3	645	VITEL GX53	161
JB4	646	WC59	644
JB5	646	WCR275BLACK	640
JB6	647	WL041 IP	513
JB7	647	WL060	534
KASA R GU10	24	WL070	552
KASA RX GU10	24	WL070 RGBW	553
KORY R SENSOR	46	WL075	523
KORY R	46	WL220 MAINS	522
LEDEP10	636	WL340	492
LENTUS	380	WL342	492
LINEAR 2 C	359	WL94	372

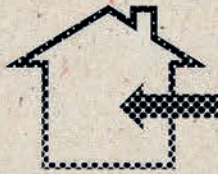

## LUMINAIRES INTÉRIEURS

	<b>COLLERETTES</b>	<b>20</b>
	<b>SPOTS</b>	<b>36</b>
	<b>SEMI-ENCASTRÉS</b>	<b>92</b>
	<b>DOWNLIGHTS</b>	<b>116</b>
<b>NEW</b>	<b>DALLES LED</b>	<b>142</b>
	<b>ENCASTRÉS MURAUX</b>	<b>150</b>
	<b>APPLIQUES</b>	<b>158</b>
	<b>PLAFONNIERS</b>	<b>192</b>
	<b>SUSPENSIONS</b>	<b>238</b>
	<b>BANDEAUX &amp; PROFILS</b>	<b>262</b>
	<b>RAILS &amp; PROJECTEURS</b>	<b>290</b>
	<b>LIGNES CONTINUES</b>	<b>354</b>
	<b>HUBLOTS</b>	<b>362</b>
<b>NEW</b>	<b>RÉGLETTES ÉTANCHES</b>	<b>374</b>
<b>NEW</b>	<b>HIGH BAY</b>	<b>378</b>



## LUMINAIRES EXTÉRIEURS

	<b>ENCASTRÉS DE SOL</b>	<b>388</b>
	<b>SPOTS SUR PIQUETS</b>	<b>430</b>
	<b>BORNES</b>	<b>456</b>
	<b>ENCASTRÉS MURAUX</b>	<b>482</b>
	<b>APPLIQUES</b>	<b>498</b>
	<b>PLAFONNIERS</b>	<b>556</b>
	<b>PROJECTEURS</b>	<b>572</b>
	<b>SPOTS</b>	<b>584</b>
<b>NEW</b>	<b>RÉGLETTES WALL-WASHER</b>	<b>590</b>
	<b>SOLAIRES</b>	<b>594</b>
	<b>MOBILES</b>	<b>602</b>

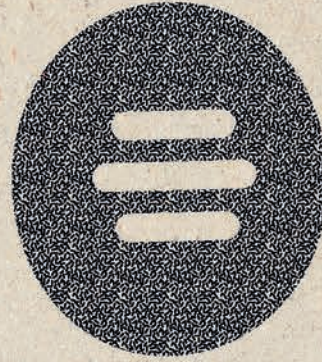
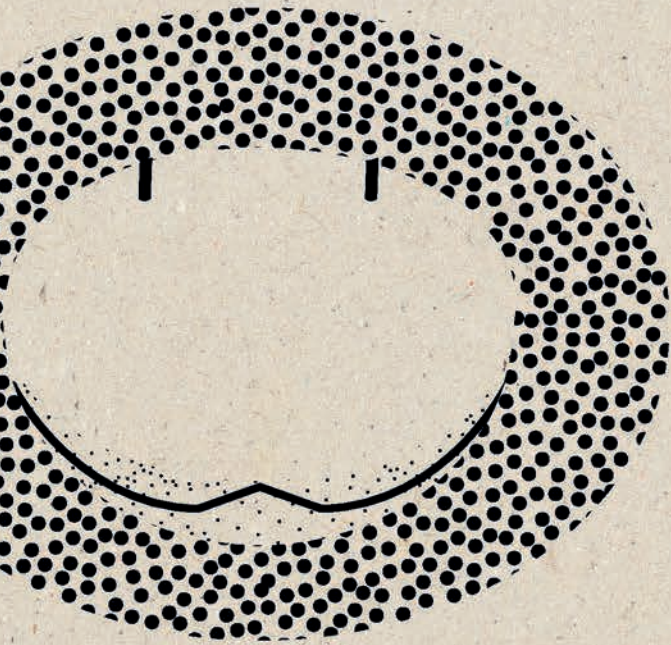

# INDIGO

## LIGHTING

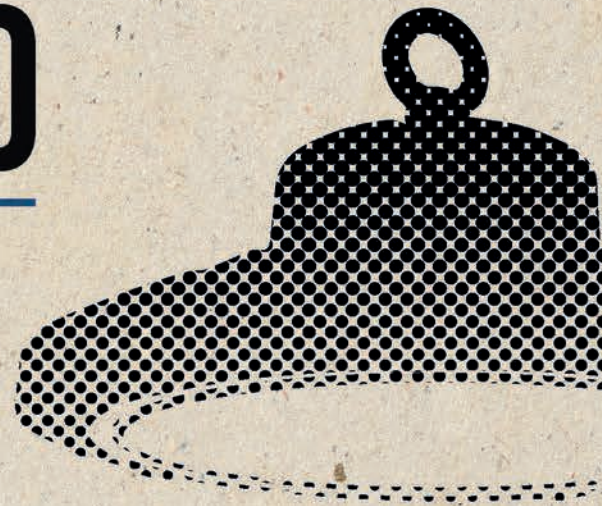

### ACCESSOIRES

	<b>SOURCES ET DOUILLES</b>	<b>616</b>
	<b>ALIMENTATIONS</b>	<b>620</b>
	<b>GESTION D'ÉCLAIRAGE</b>	<b>626</b>
<b>NEW</b>	<b>CÂBLES</b>	<b>636</b>
<b>NEW</b>	<b>BOÎTES DE RACCORDEMENT ET CONNECTEURS IP</b>	<b>640</b>

	<b>PICTOGRAMMES</b>	<b>648</b>
<b>C</b>	<b>INDEX Collingwood</b>	<b>656</b>
	<b>INDEX GÉNÉRAL</b>	<b>660</b>



**COLLERETTES**



**SPOTS**



**SEMI-ENCASTRÉS**



**DOWNLIGHTS**





**COLLERETTES**

				
FJI R GU10 30	COMO RX GU10 31	HD1050 R GU10 32	IPHO R GU10 AUTO 35	IPHO S GU10 AUTO 35

ALA1013 RX GU10 AUTO ..... 26	IPHO R GU10 AUTO ..... 35
ALA1013 SX GU10 AUTO ..... 26	IPHO S GU10 AUTO ..... 35
BALI R GU10 ..... 30	KASA R GU10 ..... 24
COMO RX GU10 ..... 31	KASA RX GU10 ..... 24
DLK2072 RX GU10 ..... 28	KS1800 RX GU10 AUTO ..... 29
FJI R GU10 ..... 30	KSA 1002 R GU10 AUTO ..... 22
HD1050 R GU10 ..... 33	KSA 1002 R GU10 AUTO ..... 23
HD1070 R GU5.3 ..... 33	KSA 1012 RX GU10 AUTO ..... 23

**SPOTS**

	<b>NEW</b> 	<b>NEW</b> 	<b>NEW</b> 	<b>NEW</b> 
MARY RDX-230 45	KORY R 46	KORY R SENSOR 46	BRAVA RD-230 48	BRAVA RDH-230 49
				
BORA SDX 57	ALEX RDX 58	AL1014 RX 60	AL1014 RDX 60	AL2014 SDX 61
				
SWEET RD 68	SILK RDX 70	SILK RDX WARM 71	AL3012 RD 72	AL3012 RD WARM 72
				
ALLY 3 RDX 79	ALLY 4 RDX 79	AL1015 RX 80	AL1015 SX 80	DOTS 82

ABY 1 RD ..... 74	IENA RDX-230 ..... 54
ABY 2 RD ..... 75	IENA RDX ..... 54
ABY 3 RD ..... 75	IPHO 82 RD ..... 64
AL1014 RDX ..... 60	IPHO 82 SD ..... 64
AL1014 RX ..... 60	JADE RDX ..... 78
AL1015 RX ..... 80	KACI R-B ..... 41
AL1015 SX ..... 80	KALI R-230 B ..... 40
AL2014 SDX ..... 61	KORY R SENSOR ..... 46
AL3012 RD WARM ..... 72	KORY R ..... 46
AL3012 RD ..... 72	LARY RD ..... 62
ALEX RDX ..... 58	LARY SD ..... 62
ALIS 1014 RDX ..... 61	LASY RX ..... 38
ALLY 3 RDX ..... 79	LENA POWER ..... 89
ALLY 4 RDX ..... 79	LENA ..... 88
BORA RDX-230 ..... 56	LISY RD ..... 44
BORA RDX ..... 57	LISY RDX ..... 44
BORA SDX ..... 57	MARY RDX-230 ..... 45
BRAVA RD-230 ..... 48	MOWI RD ..... 66
BRAVA RDH-230 ..... 49	RONGA 1 RDX-B ..... 76
COPE RD ..... 67	RONGA 2 RDX-B ..... 77
DEBI RD-230 ..... 52	RONGA 3 RDX-B ..... 77
DEBI RD ..... 52	SILK RDX WARM ..... 71
DOTS ..... 82	SILK RDX ..... 70
DUCA POWER ..... 87	SORA POWER ..... 90
DUCA ..... 86	SPOTI R-B ..... 39
EPI RD ..... 67	SWEET RD ..... 68
GARI POWER ..... 85	SYLA RD-B ..... 73
GARI ..... 84	TIBLI R-B ..... 38
H2 LITE CSP ..... 51	TIPI RX ..... 42
H2 LITE SELECT ..... 50	TIPI SX ..... 42

**SEMI-ENCASTRÉS**

				
ALLY 2 RX 102	ALLY 2 RDX 102	CLIC RDX MINI 104	CLIC RDX 104	EDDY RX 106
				
SIRA R SENSOR IR 114				

AKIS R GU10 ..... 94	EDDY RX ..... 106
ALLY 1 RDX ..... 100	FILI 1 RX-B ..... 108
ALLY 1 RX ..... 100	FILI 1 RX GU10 AUTO ..... 96
ALLY 2 RDX ..... 102	FILI 5 RDX-B ..... 109
ALLY 2 RX ..... 102	FILI 5 RX-B GU10 AUTO ..... 97
CLARA 1 RDX ..... 98	JOY RX ..... 107
CLARA 2 RDX ..... 98	KARL 1 RDX ..... 112
CLIC RDX MINI ..... 104	KARL 2 RDX ..... 112
CLIC RDX ..... 104	OKTO RX GU10 ..... 95
DEAN RDX PLUS ..... 110	SIRAR SENSOR IR ..... 114
DEAN RX ..... 110	SIRAR ..... 114

**DOWNLIGHTS**

				<b>NEW</b> 
FOX 2 RD 124	CURLI 1 RD 126	CURLI 2 RD 127	CURLI 3 RD 127	THEA PRO 1 129
				
SPIRA 1 RX PLUS 138	SPIRA 3 RX 138	FOCEA 1 SX PLUS 140	FOCEA 2 SX 140	

AL1016 RX ..... 136	LYON 4 R ..... 133
CURLI 1 RD ..... 126	SENSO R-230 ..... 118
CURLI 2 RD ..... 127	SPIRA 1 RX PLUS ..... 138
CURLI 3 RD ..... 127	SPIRA 3 RX ..... 138
DAX RD 230 ..... 118	THEALITE CSP 1 ..... 122
FOCEA 1 SX PLUS ..... 140	THEALITE CSP 2 ..... 123
FOCEA 2 SX ..... 140	THEALITE CSP 3 ..... 123
FOX 2 RD ..... 124	THEA PRO 1 ..... 129
IZA 1 SDX ..... 134	THEA PRO 2 ..... 128
IZA 2 SDX ..... 134	TIGA 1 RD ..... 120
LYON 1 R ..... 130	TIGA 2 RD ..... 120
LYON 2 R ..... 131	TIGA 3 RD ..... 120
LYON 3 R ..... 132	

DALLES LED



**NEW** SOLIS 1 144    **NEW** SOLIS 2 145    **NEW** SOLIS 3 145    **NEW** SOLIS IP65 146    **NEW** SOLIS PRO 146    **NEW** SOLIS PRO CSP 147    **NEW** DOMINO 148    **NEW** DOMINO CSP 148

ENCASTRÉS MURAUX



KO 703R 152    KO 703S 152    EVA 65R 154    EVA 65S 154    LIKA 156    MAKA 157

APPLIQUES



**NEW** EVIA G9 160    **NEW** VITEL GX53 161    OKTO 2 GU10 162    SNOOP GU10 164    SNOOP 164    AUREA 1 W 166    AUREA 2 W 167    AUREA 3 W 168  
 BETSY 1 174    BETSY 2 175    KAVA 176    FULLA 176    GLAM 164 178    ELLA 178    GLAM 265 180    GLAM 90 180  
 MALTA 1 187    MALTA 2 187    **NEW** PLANK 1 188    **NEW** PLANK 2 188    LONGA 190

PLAFONNIERS



ALBA R GU10 194    ALBA S GU10 195    LUPO 1 GU10 196    MANYL 2 GU10 196    OKTO GU10 198    OKTO C GU10 198    OKTO 1 C GU10 200    OKTO 2 C GU10 200  
 RIVA 3 GU10 204    RIVA 4 GU10 205    EVA 62 R 206    EVA 62 S 206    HAPPY 1 208    HAPPY 2 209    HAPPY 3 210    DOTS C 211  
 AUREA 1 C 219    AUREA 2 C 219    CLAC 1 MINI 220    CLAC 2 MINI 220    CLAC 221    PIXA 1 222    PIXA 2 222    PIXA 3 223  
**NEW** NOVA CSP 1 C 228    **NEW** NOVA CSP 2 C 228    **NEW** NOVA CSP 3 C 229    CAPRI R 1 C 230    CAPRI R 2 C 231    CAPRI R 3 C 231    CAPRI S 1 C 232    CAPRI S 2 C 232

**NEW**

**DALLES LED**

DOMINO CSP .....	148	SOLIS 3 .....	145
DOMINO .....	148	SOLIS IP65 .....	146
SOLIS 1 .....	144	SOLIS PRO CSP .....	147
SOLIS 2 .....	145	SOLIS PRO .....	146

**ENCASTRÉS MURAUX**

EVA 65R .....	154	KO 703S .....	152
EVA 65S .....	154	LIKA .....	156
KO 703R .....	152	MAKA .....	157

**APPLIQUES**

AUREA 1 W .....	166	HEDI .....	184
AUREA 2 W .....	167	KAVA .....	176
AUREA 3 W .....	168	LONGA .....	190
AUREA 4 W .....	168	MALTA 1 .....	187
BETSY 1 .....	174	MALTA 2 .....	187
BETSY 2 .....	175	MILO 1 .....	170
BIXBY .....	184	MILO 2 .....	170
ELLA .....	178	MILO 3 .....	172
EVIA G9 .....	160	MILO 4 .....	173
FOLD 1 .....	186	OKTO 2 GU10 .....	162
FOLD 2 .....	186	PLANK 1 .....	188
FULLA .....	176	PLANK 2 .....	188
GLAM 164 .....	178	SNOOP GU10 .....	164
GLAM 250 .....	182	SNOOP .....	164
GLAM 265 .....	180	VITEL GX53 .....	161
GLAM 90 .....	180		



**PLAFONNIERS**

ALBA R GU10 .....	194	MANYL 1 .....	214
ALBA S GU10 .....	195	MANYL 2 GU10 .....	196
AUREA 1 C .....	218	MANYL 2 .....	214
AUREA 2 C .....	219	MOLY GU10 .....	202
CAPRIR 1 C .....	230	NOLY GU10 .....	203
CAPRIR 2 C .....	231	NOVA CSP 1 C .....	228
CAPRIR 3 C .....	231	NOVA CSP 2 C .....	228
CAPRI S 1 C .....	232	NOVA CSP 3 C .....	229
CAPRI S 2 C .....	232	OKTO 1 C GU10 .....	200
CLAC 1 MINI .....	220	OKTO 2 C GU10 .....	200
CLAC 2 MINI .....	220	OKTO 4 C GU10 .....	201
CLAC .....	221	OKTO C GU10 .....	198
DOTS C .....	211	OKTO GU10 .....	198
EVA 62 R .....	206	PIXA 1 .....	222
EVA 62 S .....	206	PIXA 2 .....	222
FILI 4 RX .....	216	PIXA 3 .....	223
HAPPY 1 .....	208	RIVA 2 GU10 .....	204
HAPPY 2 .....	209	RIVA 3 GU10 .....	204
HAPPY 3 .....	210	RIVA 4 GU10 .....	205
JUNE 1 C .....	226	RODAC .....	234
JUNE 2 C .....	227	SULLY C .....	234
JUNE 3 C .....	227	TIPO 1 C .....	224
LUPO 1 GU10 .....	196	TIPO 2 C .....	225
LUPO 1 .....	212	TOMY 1 C .....	236
LUPO 2 .....	213	YUKO GU10 .....	203

SUSPENSIONS



BANDEAUX & PROFILES



RAILS & PROJECTEURS

1 ALLUMAGE



3 ALLUMAGES



ARCHITECTURAUX

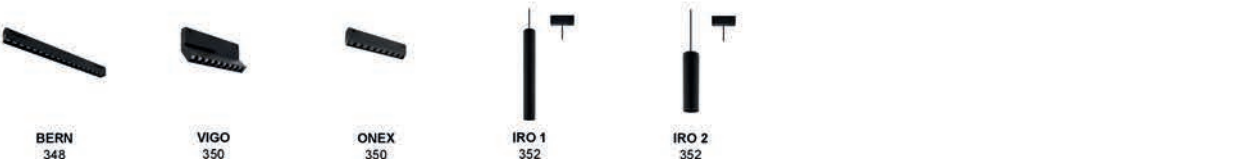

LIGNES CONTINUES



**SUSPENSIONS**



OKTO P GU10 .....	240	NOVA CSP 3 P .....	251
ZEP 400 E27 .....	242	CAPRI R 1 P .....	252
AUREA P .....	244	CAPRI R 2 P .....	252
JACK 3 P .....	245	CAPRI R 3 P .....	253
HELLO 1 P .....	246	CAPRI S 1 P .....	254
HELLO 2 P .....	246	CAPRI S 2 P .....	254
JUNE 1 P .....	248	RODA P .....	256
JUNE 2 P .....	249	SULLY P .....	256
JUNE 3 P .....	249	TOMY 1 P .....	258
NOVA CSP 1 P .....	250	TOMY 2 P .....	258
NOVA CSP 2 P .....	250	OTIS 2 P .....	260

**BANDEAUX & PROFILS**

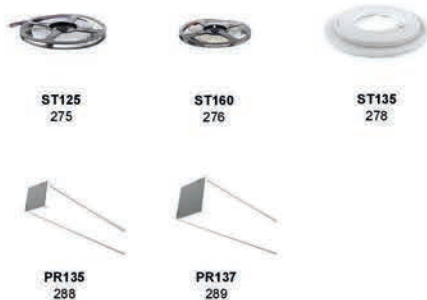

ST104 .....	266	PR115 .....	280
ST150 .....	268	PR139 .....	281
ST153 .....	269	PR117 .....	282
ST156 .....	270	PR121 .....	283
ST112 .....	271	PR127 .....	284
ST159 .....	272	PR130 .....	285
ST123 .....	273	PR146 .....	286
ST132 .....	274	PR133 .....	287
ST125 .....	275	PR135 .....	288
ST160 .....	276	PR137 .....	289
ST135 .....	278		

**RAILS & PROJECTEURS**

**1 ALLUMAGE**

JJACKT .....	298	RAY .....	300
JACK TP .....	299	TRACK UNO .....	292
OKTO T GU10 .....	296	YERA 1 T GU10 .....	294
OKTOTP GU10 .....	297	YERA 1 TP GU10 .....	294

**3 ALLUMAGES**

AUREA 3 T .....	310	LIMA 3 PLUS .....	329
AUREA 3 TP .....	310	LINEA 1 .....	330
FOCAL .....	322	LINEA 2 .....	330
FOCUS .....	323	OKTO 3 T GU10 .....	308
HALO .....	313	OKTO 3 TP GU10 .....	309
HELLO 1 D .....	314	OSIS 1 PLUS .....	317
HELLO 2 D .....	314	OSIS 1 .....	316
JACK 3 T .....	324	OSIS 2 PLUS .....	318
JACK 3 TP .....	325	OSIS 2 .....	318
JIMY 2 .....	312	TED .....	320
LIMA 1 PLUS .....	326	TRACK III SURFACE .....	304
LIMA 2 PLUS .....	328	YERA GU10 .....	306

**ARCHITECTURAUX**

ARRAS .....	347	LOOP 1 .....	340
BERN .....	348	LOOP 2 .....	340
CADIX .....	346	ONEX .....	350
IRO 1 .....	352	PARO 1 .....	342
IRO 2 .....	352	PARO 2 .....	344
KARO 1 .....	338	PARO 3 .....	345
KARO 2 .....	338	TRACK 48VDC RECESSED .....	336
KARO 3 .....	338	TRACK 48VDC SURFACE .....	334
LEGA D .....	347	VIGO .....	350



**LIGNES CONTINUES**

LINEAR 1 C .....	358	LINEAR 2 C .....	359
LINEAR 1 P .....	360	LINEAR 2 P .....	361

HUBLOTS



MINI TIMY E27  
364



MINI TIMY SENSOR E27  
364



MINI TIMY  
365



MINI TIMY SENSOR  
365



TIMY  
366



TIMY SENSOR  
367



LIDY SENSOR  
368



LIDY  
369

RÉGLETTES ÉTANCHES



NEW POLARIS  
376

HIGH BAY



NEW LENTUS  
380



NEW SPRINGBOK LITE 1  
381



NEW SPRINGBOK LITE 2  
382



NEW SPRINGBOK LITE 3  
383



NEW EAZY  
384

ENCASTRÉS DE SOL



KO2000 R GU10  
390



KO2000 S GU10  
390



WALKER E27  
391



MINI 6  
392



TINY R  
393



PURE 45  
394



PURE 55  
394



SWIM  
395



GYRO A  
399



RODI A  
400



BIG RODI A  
400

NEW



GL09  
403

NEW



GL08  
403

NEW



GL07  
404

NEW



GL06  
405

NEW



GL045  
405



NEW GL019 LG  
410



NEW GL019 F  
411



NEW GL019 SQ  
412

NEW



GL016  
413

NEW



GL016 SQ  
414

NEW



GL016 F  
415

NEW



GL063  
416

NEW



GL064  
417



NEW GL008 RGBW  
425



NEW GL090 RGBW  
426



NEW GL040 CA RGB  
427

NEW



GL016 RGBW  
428

NEW



GL050 RGBW  
429

SPOTS SUR PIQUETS



LUXI 65 GU10  
433



TURA GU10  
433



OLA 1  
434

NEW



BASIL 1 P  
436

NEW



BASIL 2 P  
436

NEW



BASIL 3 P  
437



RIESA  
438



BRAMA 1  
440



ANDY  
445

NEW



SL030  
447

NEW



SL220  
448

NEW



SL220 MAINS  
449

NEW



SL230  
450

NEW



SL230 MAINS  
451

NEW



SL240  
452

NEW



SL240 MAINS  
453

**HUBLOTS**



LIDY .....	368	MINI TIMY SENSOR .....	365
LIDY A .....	370	ORKI .....	373
LIDY A SENSOR .....	370	ORKI SENSOR .....	373
LIDY SENSOR .....	368	TIMY .....	366
MINI TIMY E27 .....	364	TIMY SENSOR .....	367
MINI TIMY .....	365	<b>WL94</b> .....	372
MINI TIMY SENSOR E27 .....	364		

**NEW**

**RÉGLETTES ÉTANCHES**

<b>POLARIS</b> .....	376
----------------------	-----

**NEW**

**HIGH BAY**

<b>EAZY</b> .....	384	<b>SPRINGBOK LITE2</b> .....	382
<b>LENTUS</b> .....	380	<b>SPRINGBOK LITE3</b> .....	383
<b>SPRINGBOK LITE1</b> .....	381		

**ENCASTRÉS DE SOL**



APA RD-230 .....	397	<b>GL06</b> .....	405
BIG APA RD-230 .....	397	<b>GL063</b> .....	416
BIG RODI A .....	400	<b>GL064</b> .....	417
<b>GL008 RGBW</b> .....	424	<b>GL07</b> .....	404
<b>GL016</b> .....	413	<b>GL08</b> .....	403
<b>GL016 F</b> .....	415	<b>GL09</b> .....	402
<b>GL016 RGBW</b> .....	428	<b>GL090 RGBW</b> .....	426
<b>GL016 SQ</b> .....	414	<b>GL100</b> .....	418
<b>GL018 C</b> .....	422	<b>GL200</b> .....	419
<b>GL018 SQ</b> .....	423	<b>GYRO</b> .....	398
<b>GL019</b> .....	409	<b>GYRO A</b> .....	399
<b>GL019 F</b> .....	411	<b>KO2000 R GU10</b> .....	390
<b>GL019 LG</b> .....	410	<b>KO2000 S GU10</b> .....	390
<b>GL019 SQ</b> .....	412	<b>MINI 6</b> .....	392
<b>GL019 ULG</b> .....	410	<b>PURE 380</b> .....	396
<b>GL038</b> .....	408	<b>PURE 45</b> .....	394
<b>GL040</b> .....	406	<b>PURE 55</b> .....	394
<b>GL040 CA RGB</b> .....	427	<b>RODI A</b> .....	400
<b>GL040 ULG</b> .....	407	<b>SWIM</b> .....	395
<b>GL045</b> .....	405	<b>TINY R</b> .....	393
<b>GL050</b> .....	420	<b>WALKER E27</b> .....	391
<b>GL050 RGBW</b> .....	429	<b>WALLY A</b> .....	395

**SPOTS SUR PIQUETS**



<b>ANDY</b> .....	445	<b>SL030</b> .....	446
<b>BASIL 1 P</b> .....	436	<b>SL040A</b> .....	455
<b>BASIL 2 P</b> .....	436	<b>SL220</b> .....	448
<b>BASIL 3 P</b> .....	437	<b>SL220 MAINS</b> .....	449
<b>BRAMA 1</b> .....	440	<b>SL230</b> .....	450
<b>BRAMA 2</b> .....	440	<b>SL230 MAINS</b> .....	451
<b>GUNZY</b> .....	442	<b>SL240</b> .....	452
<b>GUNZY 2 P</b> .....	443	<b>SL240 MAINS</b> .....	453
<b>GUNZY P</b> .....	442	<b>SL250</b> .....	454
<b>LUXI 65 GU10</b> .....	432	<b>TURA GU10</b> .....	433
<b>OLA 1</b> .....	434	<b>YUKA</b> .....	444
<b>RIESA</b> .....	438		

**BORNES**



**ENCASTRÉS MURAUX**



**APPLIQUES**



**PLAFONNIERS**



**PROJECTEURS**





## BORNES



AMONT	470	LUXI 100 S P	472
AVI 1	476	LUXI 175 SENSOR P	478
AVI 2	476	LUXI 180	467
BENS P	474	LUXI 54	464
<b>BOL201</b>	479	LUXI 650	471
BREST	471	LUXI 80	479
CHASE	472	MINO P E27	458
CUBIC P	465	OLA 2	473
CYCLO	480	RAVEL	468
CYCLO SENSOR	480	RONDO P E27	458
ELNE 1	462	SETO	474
ELNE 2	462	STELLA	466
ELNE 4	462	TULO E27	460
FILO P	477	TULOSENSOR E27	460
FINN P	469		

## ENCASTRÉS MURAUX



ARTSY	495	ML01	484
DEVI	496	ML02	484
GL019 E	488	PURE 190	494
GL021	486	SLIT R	490
GL022	487	SLIT S	490
GL034	489	WL340	492
LUXI 193	497	WL342	492

## APPLIQUES



ALMA R	543	KUBO	546
ALMA S	543	LANTERN	541
ALTEA 1 GU10	501	LUXI 100 S	526
ALTEA 2 GU10	501	LUXI 120 R	506
ALTO 1 GU10	500	LUXI 120 S	507
ALTO 2 GU10	500	LUXI 139	535
ARCOLE	525	LUXI 175 SENSOR	538
BALTI A	533	LUXI 190	554
BENS W	527	LUXI 290	554
BRIKPRO 1	528	LUXI 45	536
BRIKPRO 1 A	530	LUXI 45 SENSOR	536
BRIKPRO 2	528	LUXI 95	551
BRIKPRO 2 A	530	MC010 S	542
CHERA	554	MC020 S	542
COSTE 1	510	MF02 IP	516
COSTE 2	510	MINO W E27	505
DANI	548	NORA	550
EDGY	540	ONEO A	532
ELBY R	508	OPAL	539
ELBY S	508	POLO	548
FINN W	515	RONDO W E27	505
FURY S GU10	502	UL010	518
GUNZY 2 S	524	UL010 RGBW	519
GUNZY S	524	UL030	520
HARRY A	533	UL030 RGBW	521
HUGO GU10	503	WIDO	514
ITO	512	WL041 IP	513
KADRO E27	504	WL060	534
KOPA	546	WL070	552
KOS 1 S	544	WL070 RGBW	553
KOS 2 R	544	WL075	523
KOS 2 S	544	WL220 MAINS	522

## PLAFONNIERS



ASPI 1 SENSOR PLUS	570	ROMY R GU10	558
ASPI 2 SENSOR PLUS	571	ROMY S GU10	558
FARO 1	568	SKIP	564
FARO 2	568	SKIP 2	565
ILY	560	SKIP 4	564
LEWIS	560	UNIS R	562
LUZ 1	566	UNIS S	563
LUZ 2	567		

## PROJECTEURS



CURTIS PLUS	574	RAYPRO 14	580
CURTIS SENSOR PLUS	574	RAYPRO 32	581
INDY 1 A	576	RAYPRO 32 A	581
INDY 1	577	RAYPRO 50	582
INDY 2	578	RAYPRO 50 A	582
INDY 2 A	578		

**SPOTS**



AL3012 RD OUT  
586



ADA 1 RX  
588



ADA 2 RX  
588

**RÉGLETTES  
WALL-WASHER**



**NEW**  
ULCARGB  
592

**SOLAIRES**



PARA  
596



ADES  
598



RAMA W  
598



RAMA P  
598



KALA  
600



YELY  
600

**MOBILES**



MOON  
604



MINI SHADE  
606



MINI VARA  
608



VARA  
609



LIKI  
610



SUNY 1  
612



SUNY 2  
613

**SOURCES  
ET DOUILLES**



MODU LED  
618



SUP 08 AUTO  
619

**ALIMENTATIONS**

CONVERTISSEURS COURANT CONSTANT ..... 622

CONVERTISSEURS COURANT CONSTANT NON DIMMABLES  
CONVERTISSEURS COURANT CONSTANT NON DIMMABLES IP  
CONVERTISSEURS COURANT CONSTANT DIMMABLES COUPURE DE PHASE  
CONVERTISSEURS COURANT CONSTANT DIMMABLES 1-10V  
CONVERTISSEURS COURANT CONSTANT DIMMABLES 1-10V - DALI  
CONVERTISSEURS COURANT CONSTANT DIMMABLES DALI-PUSH

CONVERTISSEURS TENSION CONSTANTE ..... 624

CONVERTISSEURS TENSION CONSTANTE NON DIMMABLES  
CONVERTISSEUR TENSION CONSTANTE NON DIMMABLE IP67  
CONVERTISSEUR TENSION CONSTANTE DIMMABLE COUPURE DE PHASE  
CONVERTISSEUR TENSION CONSTANTE DIMMABLE 0-1/10V - DALI-PUSH

**GESTION  
D'ÉCLAIRAGE**

COMMANDES ÉCLAIRAGE



CD127  
630

CONTRÔLEURS



CD136  
631



CD135  
632



CD141  
633

**NEW**



C100924  
634



CD142  
635



CD156  
635

**CÂBLES**



**NEW**  
WCR275BLACK  
640



**NEW**  
CF505RGBW  
640



**NEW**  
CR575RGBW  
641

**BOÎTES**

BOÎTES DE RACCORDEMENT ET CONNECTEURS IP



**NEW**  
WC59  
644



**NEW**  
JB1  
644



**NEW**  
JB2  
645



**NEW**  
JB3  
645



**NEW**  
JB4  
646



**NEW**  
JB5  
646



**NEW**  
JB6  
647



**NEW**  
JB7  
647

**SPOTS**

AL3012 RD OUT .....	586
ADA 1 RX .....	588
ADA 2 RX .....	588

**RÉGLETTES WALL-WASHER**

**NEW**

ULCARGB .....	592
---------------	-----

**SOLAIRES**

ADES .....	596	RAMA P .....	598
KALA .....	600	RAMA W .....	598
PARA .....	596	YELY .....	600

**MOBILES**

LIKI .....	610	SUNY 1 .....	612
MINI SHADE .....	606	SUNY 2 .....	613
MINI VARA .....	608	VARA .....	609
MOON .....	604		

**SOURCES ET DOUILLES**

MODU LED .....	618	SUP 08 AUTO .....	619
----------------	-----	-------------------	-----

**ALIMENTATIONS**

CD102 .....	623	CD153 .....	625	PLDUNIDRIVE350MA .....	622
CD104 .....	623	CD154 .....	625	PLDUNIDRIVE700MA .....	622
CD105 .....	622	CD155 .....	622	PLR35015 .....	622
CD112 .....	623	CD158 .....	624	PLU35019 .....	622
CD114 .....	622	CD159 .....	624	PLU70039 .....	622
CD116 .....	623	CD170 .....	622	PLUPP35019 .....	622
CD122 .....	623	CD171 .....	624	PSDAL350M .....	623
CD123 .....	623	CD172 .....	622	PSDAL700M .....	623
CD124 .....	623	CD173 .....	624	PSDIM350 .....	622
CD125 .....	623	CD174 .....	624	PSDIM700 .....	622
CD126 .....	623	CD175 .....	624	PSIP35018W .....	622
CD128 .....	622	CD176 .....	624	PSIP3509W .....	622
CD140 .....	623	CD177 .....	624	PSIP70018W .....	622
CD147 .....	623	CD178 .....	624	PSIP70036W .....	622
CD148 .....	623	CD179 .....	624	PSMD3501324 .....	623
CD150 .....	624	CD180 .....	624	PSMD35039 .....	623
CD151 .....	624	CD181 .....	624	PSMD70024 .....	623
				PSMD700610 .....	623

**GESTION D'ÉCLAIRAGE**

CD127 .....	630	CD141 .....	633
C100924 .....	634	CD142 .....	635
CD135 .....	632	CD156 .....	635
CD136 .....	631	LEDEP .....	636

**CÂBLES**

**NEW**

CF505RGBW .....	640
CR575RGBW .....	641
WCR275BLACK .....	640

**BOÎTES DE RACCORDEMENT ET CONNECTEURS IP**

**NEW**

JB1 .....	644	JB5 .....	646
JB2 .....	645	JB6 .....	647
JB3 .....	645	JB7 .....	647
JB4 .....	646	WC 5-9 .....	644

**KIT ÉCLAIRAGE SECOURS**



**NEW** LEDEP10  
636



# INDIGO

LIGHTING

**LUMINAIRES  
INTÉRIEURS**

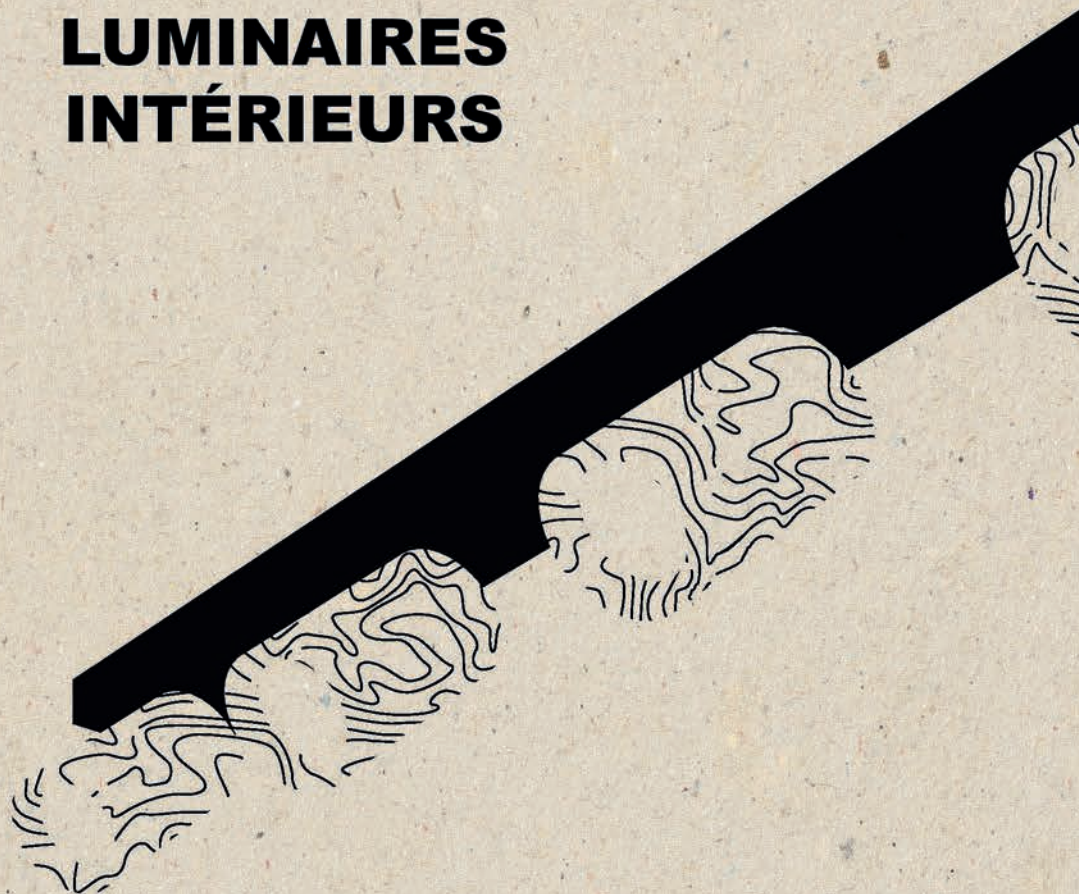

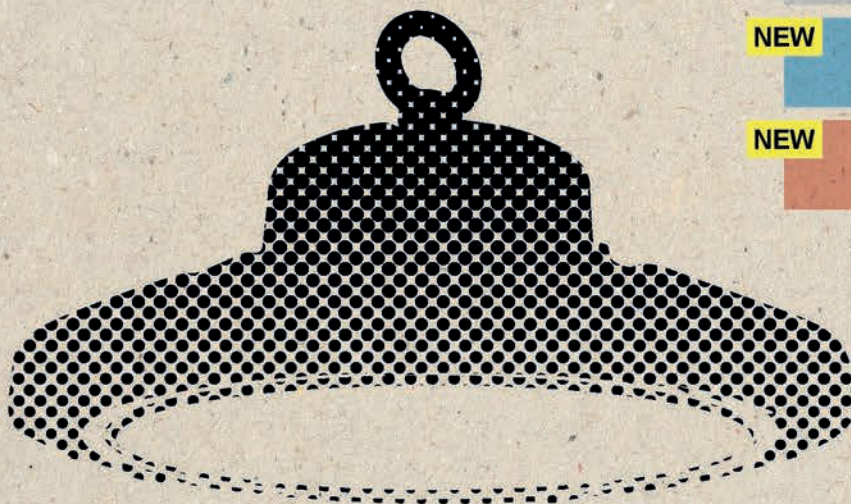
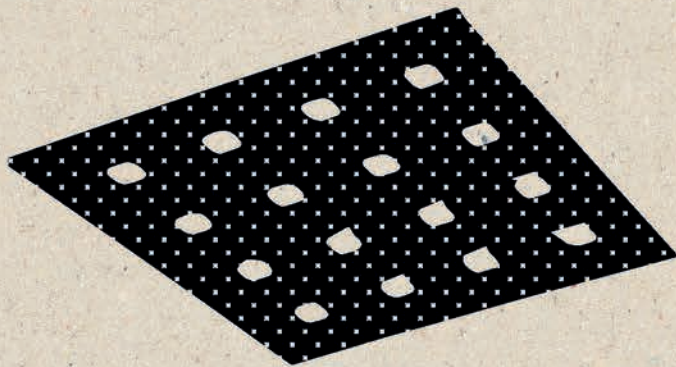
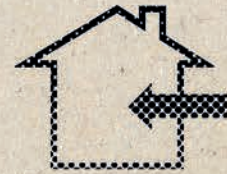

**COLLERETTES**

**SPOTS**

**SEMI-ENCASTRÉS**

**DOWNLIGHTS**

**NEW**

**DALLES LED**

**ENCASTRÉS MURAUX**

**APPLIQUES**

**PLAFONNIERS**

**SUSPENSIONS**

**BANDEAUX & PROFILS**

**RAILS & PROJECTEURS**

**LIGNES CONTINUES**

**HUBLOTS**

**NEW**

**RÉGLETTES ÉTANCHES**

**NEW**

**HIGH BAY**

# INDIGO

LIGHTING

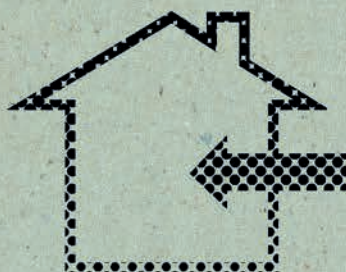

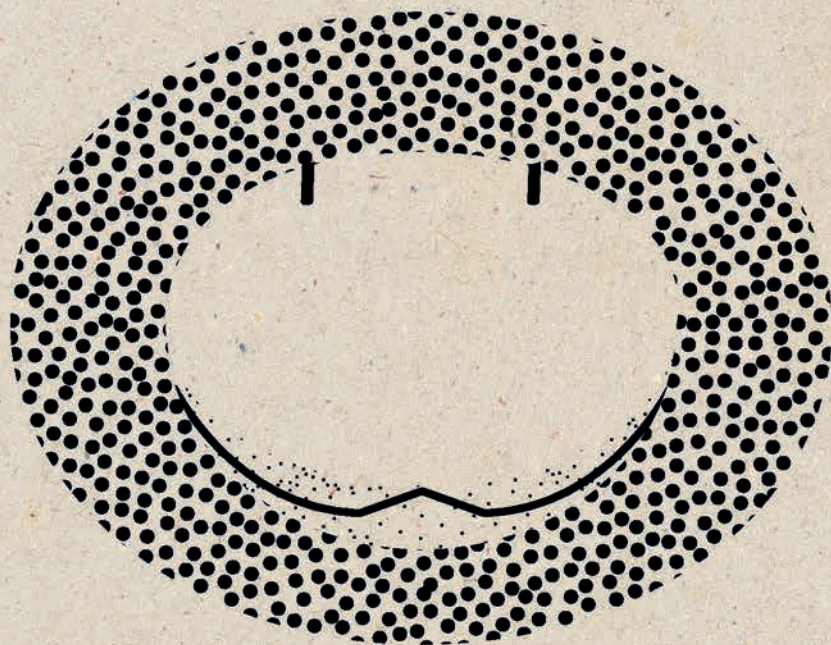

## **COLLERETTES**

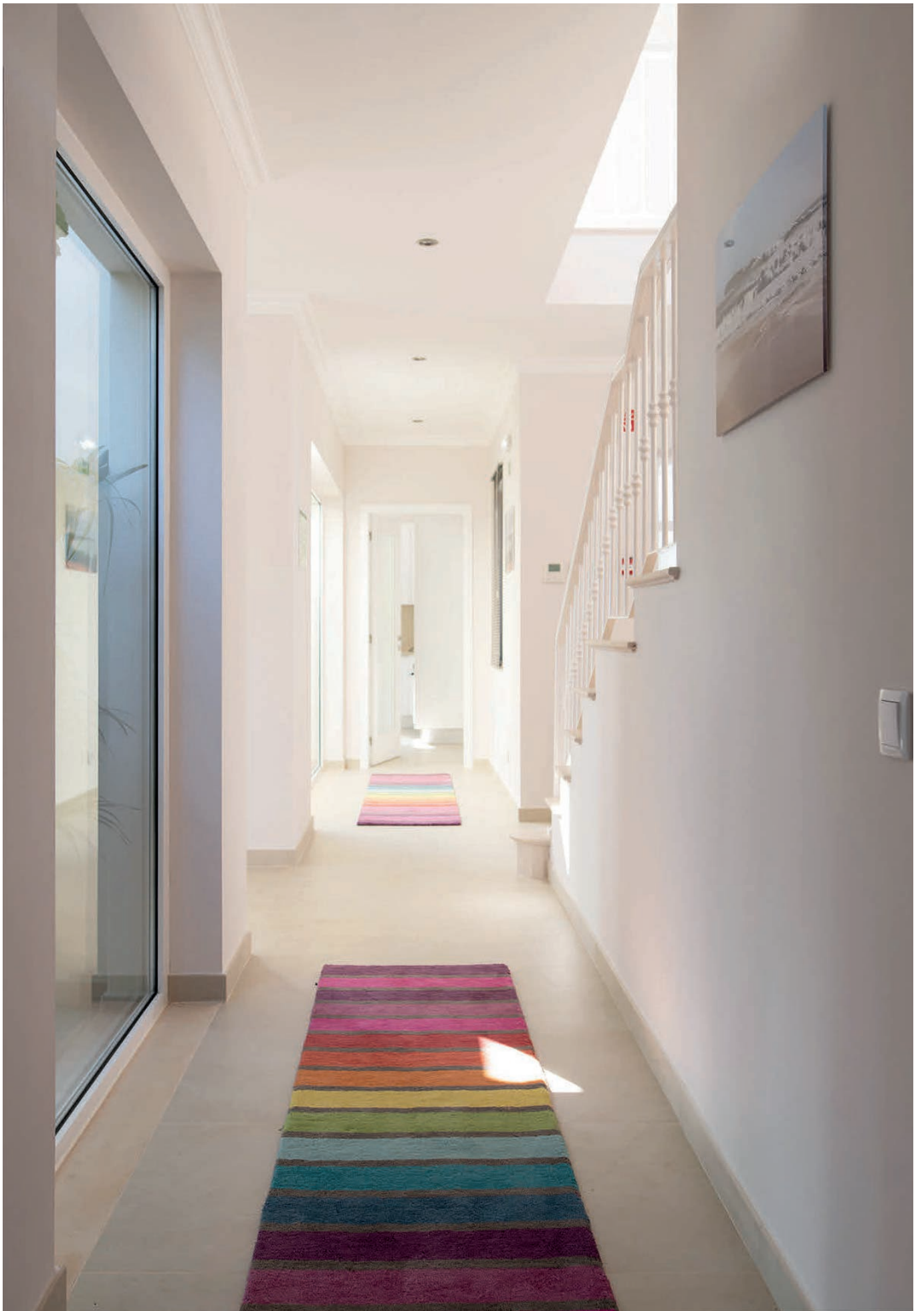





## KSA 1002 R GU10 AUTO

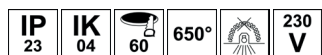

- Spot encastré rond fixe.
- Fixation par ressorts.
- Double bornier automatique.

Compatible avec MODU LED 9W dimmable.

SOURCES	LED	€
LED9W500DWW	9W	50,50 B

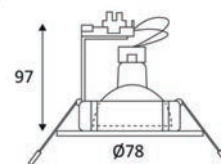

KSA 1002 R GU10 AUTO	MATIÈRE	SOCKET	LAMP	Watt Max	€
KSA100201	DORE	GU10 AUTO	PAR16	50W	7,00 B
KSA100203	CHROME	GU10 AUTO	PAR16	50W	7,00 B
KSA100204	BLANC	GU10 AUTO	PAR16	50W	6,00 B
KSA100205	NOIR	GU10 AUTO	PAR16	50W	6,00 B
KSA100209	CHROME MAT	GU10 AUTO	PAR16	50W	7,00 B
KSA100211	BRONZE ANTIQUE	GU10 AUTO	PAR16	50W	7,00 B
KSA100221	NICKEL SATINE	GU10 AUTO	PAR16	50W	7,00 B



DORE



CHROME



BLANC



NOIR



CHROME MAT



BRONZE ANTIQUE



NICKEL SATINE

## KSA 1012 RX GU10 AUTO

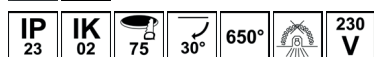

- Spot encastré rond orientable.
- Fixation par ressorts.
- Double bornier automatique.

Compatible avec MODU LED 9W dimmable.

SOURCES	LED	€
LED9W500DWW	9W	50,50 B

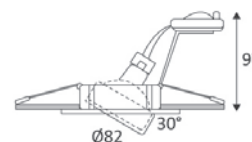

KSA 1012 RX GU10 AUTO	MATIÈRE	SOCKET	LAMP	Watt Max	€
KSA101203	CHROME	GU10 AUTO	PAR16	50W	9,00 B
KSA101204	BLANC	GU10 AUTO	PAR16	50W	7,00 B
KSA101205	NOIR	GU10 AUTO	PAR16	50W	7,00 B
KSA101209	CHROME MAT	GU10 AUTO	PAR16	50W	11,00 B
KSA101211	BRONZE ANTIQUE	GU10 AUTO	PAR16	50W	11,00 B
KSA101221	NICKEL SATINE	GU10 AUTO	PAR16	50W	9,00 B



CHROME



BLANC



NOIR



CHROME MAT



BRONZE ANTIQUE



NICKEL SATINE

NEW

## KASA R GU10

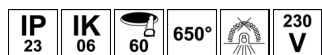



- Spot encastré rond fixe.
- Fixation par ressorts.
- Double bornier automatique.

Compatible avec MODU LED 9W dimmable.

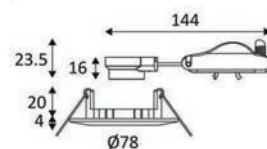
SOURCES	LED	€
LED9W500DWW 	9W	50,50 B



KASA R GU10	MATIÈRE	SOCKET	LAMP	Watt Max	€
DO54605 <b>NEW</b>  NOIR MAT	ALUMINIUM	GU10 AUTO	PAR16 LED	10W	6,00 B
DO54621 <b>NEW</b>  NICKEL SATINE	ALUMINIUM	GU10 AUTO	PAR16 LED	10W	7,00 B
DO54630 <b>NEW</b>  BLANC MAT	ALUMINIUM	GU10 AUTO	PAR16 LED	10W	6,00 B



NOIR MAT



NICKEL SATINE



BLANC MAT

NEW

## KASA RX GU10

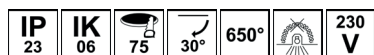



- Spot encastré rond orientable.
- Fixation par ressorts.
- Double bornier automatique.

Compatible avec MODU LED 9W dimmable.

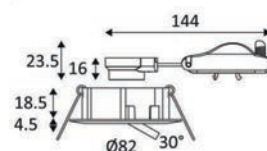
SOURCES	LED	€
LED9W500DWW 	9W	50,50 B



KASA RX GU10	MATIÈRE	SOCKET	LAMP	Watt Max	€
DO54705 <b>NEW</b>  NOIR MAT	ALUMINIUM	GU10 AUTO	PAR16 LED	10W	7,00 B
DO54721 <b>NEW</b>  NICKEL SATINE	ALUMINIUM	GU10 AUTO	PAR16 LED	10W	9,00 B
DO54730 <b>NEW</b>  BLANC MAT	ALUMINIUM	GU10 AUTO	PAR16 LED	10W	7,00 B



NOIR MAT



NICKEL SATINE



BLANC MAT



## ALA1013 RX GU10 AUTO

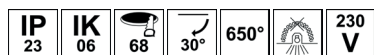



- Spot encastré rond orientable.
- Livré avec ressorts et lamelles.
- Double bornier automatique.
- Bague couvrant un diamètre de perçage de 90 à 120mm à commander séparément.

Compatible avec MODU LED 9W dimmable.

SOURCES	LED	€
LED9W500DWW 	9W	50,50 B



ALA1013 RX GU10 AUTO	MATIÈRE	SOCKET	LAMP	Watt Max	€
DO47505  NOIR MAT	ALUMINIUM	GU10 AUTO	PAR16	50W	16,50 B
ALA101325  ALUMINIUM MAT	ALUMINIUM	GU10 AUTO	PAR16	50W	16,50 B
ALA101330  BLANC MAT	ALUMINIUM	GU10 AUTO	PAR16	50W	16,50 B

ACCESSOIRES	MATIÈRE	DESCRIPTION	€
DO33305 	ALUMINIUM	BAGUE DE MONTAGE 178mm	18,50 B
DO33330 	ALUMINIUM	BAGUE DE MONTAGE 178mm	18,50 B



## ALA1013 SX GU10 AUTO

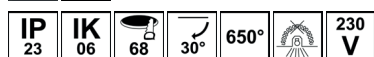

- Spot encastré carré orientable.
- Fixation par ressorts.
- Double bornier automatique.

Compatible avec MODU LED 9W dimmable.

SOURCES	LED	€
LED9W500DWW 	9W	50,50 B



ALA1013 SX GU10 AUTO	MATIÈRE	SOCKET	LAMP	Watt Max	€
DO47605  NOIR MAT	ALUMINIUM	GU10 AUTO	PAR16	50W	26,80 B
ALA1013S25  ALUMINIUM MAT	ALUMINIUM	GU10 AUTO	PAR16	50W	26,80 B
ALA1013S30  BLANC MAT	ALUMINIUM	GU10 AUTO	PAR16	50W	26,80 B



NOIR MAT

ALUMINIUM MAT

BLANC MAT

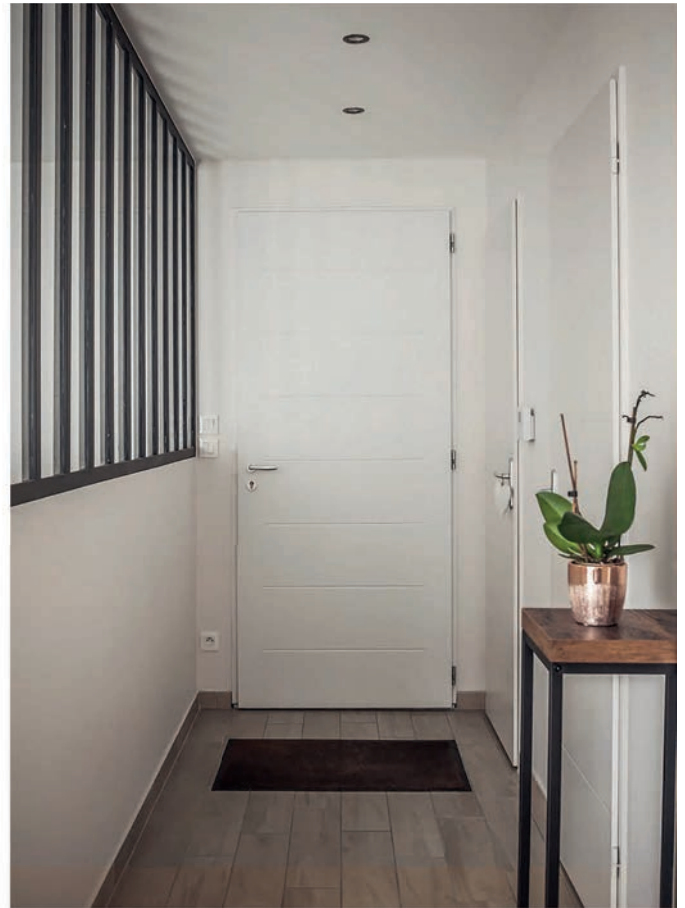

## DLK2072 RX GU10

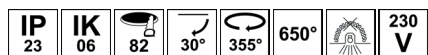

- Spot encastré rond orientable.
- 3 couronnes.
- Fixation par ressorts.

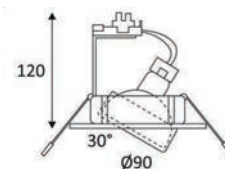

DLK2072 RX GU10		MATIÈRE	SOCKET	LAMP	Watt Max	€
DLK207204	BLANC	FONTE D'ALUMINIUM	GU10	PAR16	50W	26,80 B
DLK207215	INOX BROSSE	FONTE D'ALUMINIUM	GU10	PAR16	50W	31,90 B
DLK207221	NICKEL SATINE	FONTE D'ALUMINIUM	GU10	PAR16	50W	34,00 B



BLANC



INOX BROSSE



NICKEL SATINE

## KS1800 RX GU10 AUTO

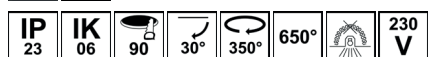

- Spot encastré rond orientable.
- Fixation par ressorts.
- Double bornier automatique.

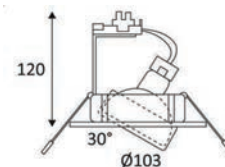

KS1800 RX GU10 AUTO		MATIÈRE	SOCKET	LAMP	Watt Max	€
KS180005	NOIR MAT	FONTE D'ALUMINIUM	GU10 AUTO	PAR16	50W	21,60 B
KS180030	BLANC MAT	FONTE D'ALUMINIUM	GU10 AUTO	PAR16	50W	21,60 B



NOIR MAT



BLANC MAT



## BALI R GU10



- Spot encastré rond fixe.
- Réflecteur basse luminance.
- Fixation par ressorts.

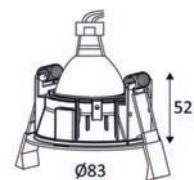

BALI R GU10		MATIÈRE	SOCKET	LAMP	Watt Max	€
DO51305		NOIR MAT	ALUMINIUM	GU10	PAR16 LED	10W 25,80 B
DO51308		NOIR MAT - CHAMPAGNE	ALUMINIUM	GU10	PAR16 LED	10W 28,80 B
DO51317		NOIR MAT - ARGENT	ALUMINIUM	GU10	PAR16 LED	10W 28,80 B
DO51330		BLANC MAT	ALUMINIUM	GU10	PAR16 LED	10W 25,80 B
DO51349		BLANC MAT - CHAMPAGNE	ALUMINIUM	GU10	PAR16 LED	10W 28,80 B
DO51353		BLANC MAT - ARGENT	ALUMINIUM	GU10	PAR16 LED	10W 28,80 B



NOIR MAT



NOIR MAT - CHAMPAGNE



NOIR MAT - ARGENT



BLANC MAT



BLANC MAT - CHAMPAGNE



BLANC MAT - ARGENT

## FIJI R GU10



- Spot encastré rond fixe.
- Réflecteur basse luminance.
- Fixation par ressorts.

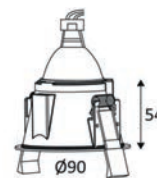

FIJI R GU10		MATIÈRE	SOCKET	LAMP	Watt Max	€
DO51405		NOIR MAT	ALUMINIUM	GU10	PAR16 LED	10W 24,70 B
DO51408		NOIR MAT - CHAMPAGNE	ALUMINIUM	GU10	PAR16 LED	10W 30,90 B
DO51417		NOIR MAT - ARGENT	ALUMINIUM	GU10	PAR16 LED	10W 30,90 B
DO51430		BLANC MAT	ALUMINIUM	GU10	PAR16 LED	10W 24,70 B
DO51449		BLANC MAT - CHAMPAGNE	ALUMINIUM	GU10	PAR16 LED	10W 30,90 B
DO51453		BLANC MAT - ARGENT	ALUMINIUM	GU10	PAR16 LED	10W 30,90 B



NOIR MAT



NOIR MAT - CHAMPAGNE



NOIR MAT - ARGENT



BLANC MAT



BLANC MAT - CHAMPAGNE



BLANC MAT - ARGENT





## COMO RX GU10

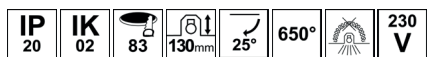

- Spot encastré rond orientable.
- Réflecteur basse luminance.
- Fixation par ressorts.

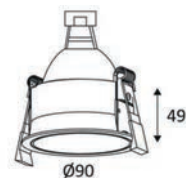

COMO RX GU10		MATIÈRE	SOCKET	LAMP	Watt Max	€
DO51805	■ NOIR MAT	ALUMINIUM	GU10	PAR16 LED	10W	26,80 B
DO51808	■ NOIR MAT - CHAMPAGNE	ALUMINIUM	GU10	PAR16 LED	10W	33,00 B
DO51817	■ NOIR MAT - ARGENT	ALUMINIUM	GU10	PAR16 LED	10W	33,00 B
DO51830	■ BLANC MAT	ALUMINIUM	GU10	PAR16 LED	10W	26,80 B
DO51849	■ BLANC MAT - CHAMPAGNE	ALUMINIUM	GU10	PAR16 LED	10W	33,00 B
DO51853	■ BLANC MAT - ARGENT	ALUMINIUM	GU10	PAR16 LED	10W	33,00 B



NOIR MAT



NOIR MAT -  
CHAMPAGNE



NOIR MAT - ARGENT



BLANC MAT



BLANC MAT -  
CHAMPAGNE



BLANC MAT -  
ARGENT



## HD1050 R GU10

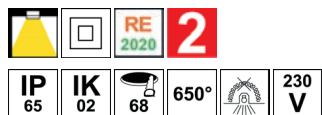

- Spot encastré rond fixe.
- Verre de protection sablé.
- Fixation par ressorts.

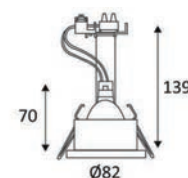

HD1050 R GU10		MATIÈRE	SOCKET	LAMP	Watt Max	€
HD105004	BLANC	ALUMINIUM	GU10	PAR16	50W	18,50 B
HD105021	NICKEL SATINE	ALUMINIUM	GU10	PAR16	50W	19,60 B



BLANC

NICKEL SATINE

## HD1070 R GU5.3



- Spot encastré rond fixe.
- Verre de protection sablé.
- Fixation par ressorts.
- Transformateur à commander séparément.

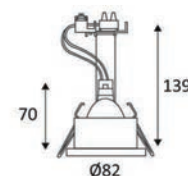

HD1070 R GU5.3		MATIÈRE	SOCKET	LAMP	Watt Max	€
HD107004	BLANC	ALUMINIUM	GU5.3	MR16	50W	18,50 B
HD107021	NICKEL SATINE	ALUMINIUM	GU5.3	MR16	50W	19,60 B



BLANC

NICKEL SATINE







## IPHO R GU10 AUTO

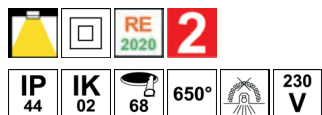

- Spot encastré rond fixe.
- Fixation par ressorts.
- Double bornier automatique.

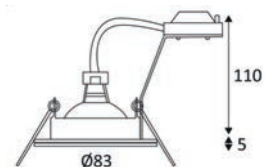

IPHO R GU10 AUTO	MATIÈRE	SOCKET	LAMP	Watt Max	€
DO19705	NOIR	GU10 AUTO	PAR16	20W	36,00 B
DO19730	BLANC	GU10 AUTO	PAR16	20W	36,00 B



NOIR



BLANC



### IPHO 82 RD

DANS LA MÊME GAMME  
PAGE 64

## IPHO S GU10 AUTO

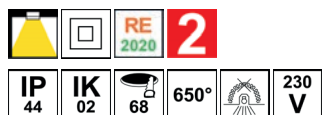

- Spot encastré carré fixe.
- Fixation par ressorts.
- Double bornier automatique.

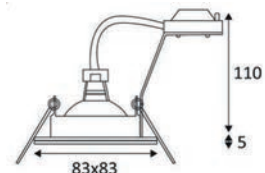

IPHO S GU10 AUTO	MATIÈRE	SOCKET	LAMP	Watt Max	€
DO21205	NOIR	GU10 AUTO	PAR16	20W	38,10 B
DO21230	BLANC	GU10 AUTO	PAR16	20W	38,10 B



NOIR



BLANC



### IPHO 82 SD

DANS LA MÊME GAMME  
PAGE 64

# INDIGO

LIGHTING

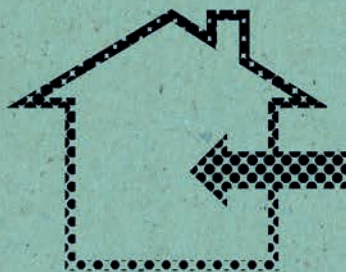

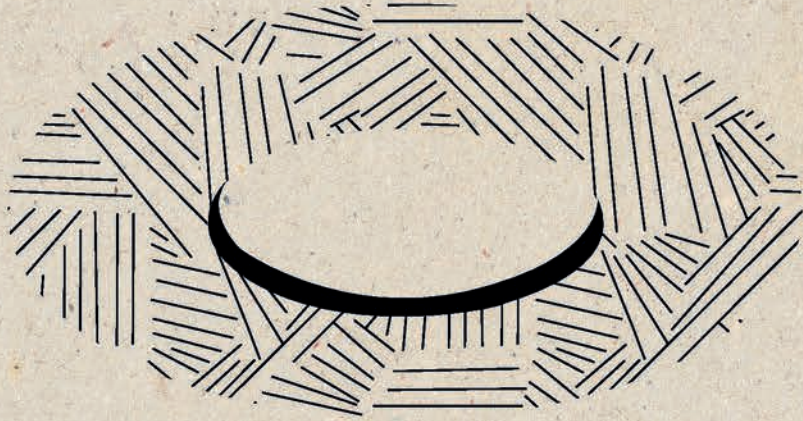

## **SPOTS**

## LASY RX



- Spot encastré rond orientable.
- Fixation par ressorts.
- Peut être recouvert par un isolant déroulé.
- Double bornier automatique.
- Convertisseur non dimmable déporté fourni.

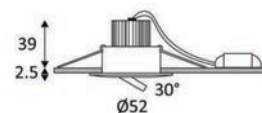

LASY RX		MATIÈRE	LED	T°	LED Lumen	System Lumen	€
DO334WW05	NOIR MAT	FONTE D'ALUMINIUM	1W	3000K	100 Lm	90 Lm	44,30 B
DO334WW25	ALUMINIUM SATINE	FONTE D'ALUMINIUM	1W	3000K	100 Lm	90 Lm	44,30 B
DO334WW30	BLANC MAT	FONTE D'ALUMINIUM	1W	3000K	100 Lm	90 Lm	44,30 B



NOIR MAT



ALUMINIUM SATINE



BLANC MAT

## TIBLI R-B

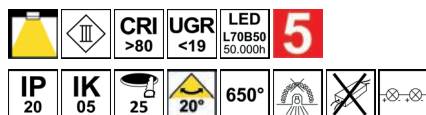

- Spot encastré rond fixe.
- Fixation par lamelles.
- Connecteur rapide et 2.00m de câble inclus.
- Convertisseur dimmable 350mA (montage déporté du convertisseur) à commander séparément (CD167 min. 2W max. 4W, compatible avec variateur début et fin de phase).

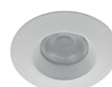
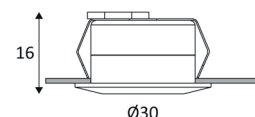

TIBLI R-B		MATIÈRE	LED	T°	LED Lumen	System Lumen	€
DO468WW05	NOIR MAT	ALUMINIUM	1,2W	3000K	115 Lm	106 Lm	33,00 B
DO468WW30	BLANC MAT	ALUMINIUM	1,2W	3000K	115 Lm	106 Lm	33,00 B

ACCESSOIRES	DESCRIPTION	€
CD167	DRIVER 2-4W 350mA CC DIM	25,80 B

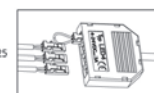
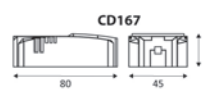

NOIR MAT



BLANC MAT





## SPOTI R-B

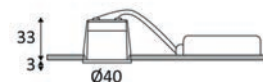
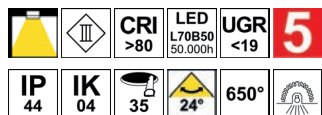

- Spot encastré rond fixe.
- Fixation par lamelles.
- Précâblé 1.50m.
- Peut être recouvert par un isolant déroulé.
- Double bornier automatique.
- Convertisseur non dimmable déporté fourni, peut être placé à max. 10m de l'appareil.

SPOTI R-B	MATIÈRE	LED	T°	LED Lumen	System Lumen	€	
DO241SW25	ALUMINIUM	FONTE D'ALUMINIUM	4,5W	2700K	480 Lm	416 Lm	59,70 B
DO241SW30	BLANC MAT	FONTE D'ALUMINIUM	4,5W	2700K	480 Lm	416 Lm	59,70 B
DO241SW38	ANTHRACITE ANODISE	FONTE D'ALUMINIUM	4,5W	2700K	480 Lm	341 Lm	59,70 B
DO241WW25	ALUMINIUM	FONTE D'ALUMINIUM	4,5W	3000K	480 Lm	445 Lm	59,70 B
DO241WW30	BLANC MAT	FONTE D'ALUMINIUM	4,5W	3000K	480 Lm	445 Lm	59,70 B
DO241WW38	ANTHRACITE ANODISE	FONTE D'ALUMINIUM	4,5W	3000K	480 Lm	365 Lm	59,70 B
DO241NW25	ALUMINIUM	FONTE D'ALUMINIUM	4,5W	4000K	490 Lm	450 Lm	59,70 B
DO241NW30	BLANC MAT	FONTE D'ALUMINIUM	4,5W	4000K	490 Lm	450 Lm	59,70 B
DO241NW38	ANTHRACITE ANODISE	FONTE D'ALUMINIUM	4,5W	4000K	490 Lm	375 Lm	59,70 B



ALUMINIUM

BLANC MAT

ANTHRACITE ANODISE



## KALI R-230 B

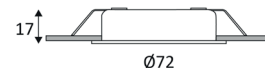

- Spot encastré rond.
- Diffuseur en verre opalin.
- Fixation par lamelles.
- Peut être recouvert par un isolant déroulé.
- Double bornier automatique.
- Ne nécessite pas de convertisseur.
- Non dimmable.
- Accessoire pour pose apparente à commander séparément.

KALI R-230 B		MATIÈRE	LED	T°	LED Lumen	System Lumen	€
DO337WW05	■ NOIR MAT	ALUMINIUM	4,7W	3000K	410 Lm	280 Lm	57,70 B
DO337WW21	■ NICKEL SATINE	ALUMINIUM	4,7W	3000K	410 Lm	280 Lm	59,70 B
DO337WW30	■ BLANC MAT	ALUMINIUM	4,7W	3000K	410 Lm	280 Lm	57,70 B

ACCESSOIRES		MATIÈRE	DESCRIPTION	€
DO33805	■ NOIR MAT	ALUMINIUM	KALI R-230 B BASE RONDE	27,80 B
DO33821	■ NICKEL SATINE	ALUMINIUM	KALI R-230 B BASE RONDE	27,80 B
DO33830	■ BLANC MAT	ALUMINIUM	KALI R-230 B BASE RONDE	27,80 B



NOIR MAT

NICKEL SATINE

BLANC MAT





## KACI R-B

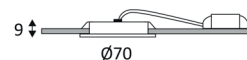
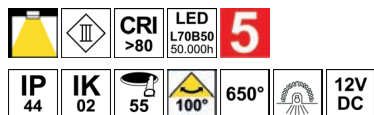

- Spot encastré rond.
- Diffuseur en verre dépoli.
- Fixation par lamelles.
- Précâblé 0.50m.
- Peut être recouvert par un isolant déroulé.
- Double bornier automatique.
- Convertisseur non dimmable déporté fourni, peut être placé à max. 10m de l'appareil.
- Accessoire pour pose apparente à commander séparément.



KACI R-B	MATIÈRE	LED	T°	LED Lumen	System Lumen	€
KC211R25	ALUMINIUM BROSSE	3W	3000K	350 Lm	220 Lm	57,70 B
KC211R30	BLANC MAT	3W	3000K	350 Lm	220 Lm	57,70 B

ACCESSOIRES	MATIÈRE	DESCRIPTION	€
BASEKC211R25	ALUMINIUM BROSSE	KACI R-B BASE RONDE	27,80 B
BASEKC211R30	BLANC MAT	KACI R-B BASE RONDE	27,80 B



ALUMINIUM BROSSE      BLANC MAT



## TIPI RX

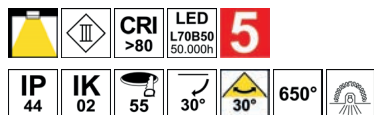

- Spot encastré rond orientable.
- Fixation par ressorts.
- Peut être recouvert par un isolant déroulé.
- Double bornier automatique.
- Convertisseur non dimmable déporté fourni, peut être placé à max. 10m de l'appareil.

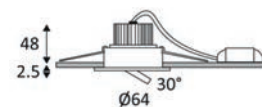

TIPI RX		MATIÈRE	LED	T°	LED Lumen	System Lumen	€
DO104WW05	NOIR MAT	FONTE D'ALUMINIUM	3W	3000K	350 Lm	300 Lm	57,70 B
DO104WW25	ALUMINIUM	FONTE D'ALUMINIUM	3W	3000K	350 Lm	300 Lm	57,70 B
DO104WW30	BLANC MAT	FONTE D'ALUMINIUM	3W	3000K	350 Lm	300 Lm	57,70 B



NOIR MAT



ALUMINIUM



BLANC MAT

## TIPI SX



- Spot encastré carré orientable.
- Fixation par ressorts.
- Peut être recouvert par un isolant déroulé.
- Double bornier automatique.
- Convertisseur non dimmable déporté fourni, peut être placé à max. 10m de l'appareil.

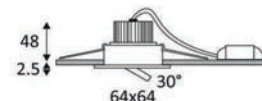

TIPI SX		MATIÈRE	LED	T°	LED Lumen	System Lumen	€
DO103WW05	NOIR MAT	FONTE D'ALUMINIUM	3W	3000K	350 Lm	300 Lm	61,80 B
DO103WW25	ALUMINIUM	FONTE D'ALUMINIUM	3W	3000K	350 Lm	300 Lm	61,80 B
DO103WW30	BLANC MAT	FONTE D'ALUMINIUM	3W	3000K	350 Lm	300 Lm	61,80 B



NOIR MAT



ALUMINIUM



BLANC MAT



## LISY RD

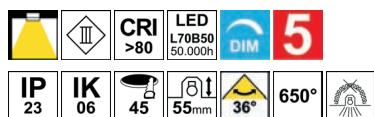

- Spot encastré rond fixe.
- Réflecteur basse luminance.
- Fixation par ressorts.
- Convertisseur dimmable déporté fourni.
- Compatible avec variateur début et fin de phase.

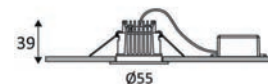

LISY RD	MATÉRIE	LED	T°	LED Lumen	System Lumen	€	
DO459WW05	NOIR MAT	FONTE D'ALUMINIUM	4,5W	3000K	600 Lm	440 Lm	60,80 B
DO459WW30	BLANC MAT	FONTE D'ALUMINIUM	4,5W	3000K	600 Lm	440 Lm	60,80 B



NOIR MAT



BLANC MAT

## LISY RDX

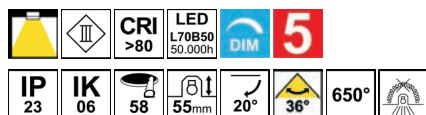

- Spot encastré rond orientable.
- Réflecteur basse luminance.
- Fixation par ressorts.
- Convertisseur dimmable déporté fourni.
- Compatible avec variateur début et fin de phase.

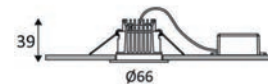

LISY RDX	MATÉRIE	LED	T°	LED Lumen	System Lumen	€	
DO460WW05	NOIR MAT	FONTE D'ALUMINIUM	4,5W	3000K	600 Lm	474 Lm	60,80 B
DO460WW30	BLANC MAT	FONTE D'ALUMINIUM	4,5W	3000K	600 Lm	474 Lm	60,80 B



NOIR MAT



BLANC MAT



## MARY RDX-230

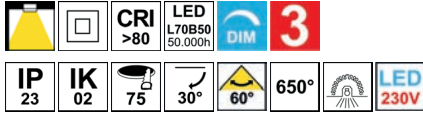

- Spot encastré rond orientable.
- Fixation par ressorts.
- Peut être recouvert par un isolant déroulé.
- Double bornier automatique.
- Ne nécessite pas de convertisseur.
- Dimmable.
- Compatible avec variateur fin de phase.



MARY RDX-230		MATIÈRE	LED	T°	LED Lumen	System Lumen	€	
DO315WW05	■	NOIR MAT	COMPOSITE	7,5W	3000K	750 Lm	600 Lm	35,00 B
DO315WW30	■	BLANC MAT	COMPOSITE	7,5W	3000K	750 Lm	600 Lm	35,00 B
DO315NW05	■	NOIR MAT	COMPOSITE	7,5W	4000K	770 Lm	615 Lm	35,00 B
DO315NW30	■	BLANC MAT	COMPOSITE	7,5W	4000K	770 Lm	615 Lm	35,00 B



NOIR MAT



BLANC MAT



NEW

## KORY R

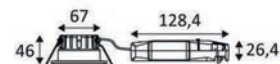
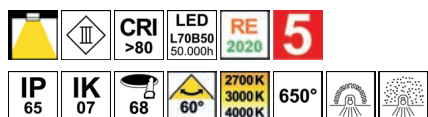

- Downlight encastré rond fixe 3 en 1.
- 2700K, 3000K ou 4000K au choix via un interrupteur dans le luminaire.
- Fixation par ressorts.
- Peut être recouvert par un isolant déroulé ou soufflé, convertisseur compris.
- Double bornier automatique.
- Convertisseur non dimmable déporté fourni.

KORY R		MATIÈRE	LED	T°	LED Lumen	System Lumen	€	
DO54905	<b>NEW</b>	NOIR MAT	ALU.+COMPOSITE	6W	2700-3000-4000K	775 Lm (4000K)	620 Lm (4000K)	36,90 A
DO54930	<b>NEW</b>	BLANC MAT	ALU.+COMPOSITE	6W	2700-3000-4000K	775 Lm (4000K)	665 Lm (4000K)	36,90 A



NOIR MAT



BLANC MAT

NEW

## KORY R SENSOR

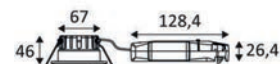
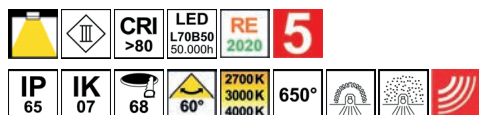

- Downlight encastré rond fixe 3 en 1.
- 2700K, 3000K ou 4000K au choix via un interrupteur dans le luminaire.
- Fixation par ressorts.
- Peut être recouvert par un isolant déroulé ou soufflé, convertisseur compris.
- Double bornier automatique.
- Avec détecteur IR 90°, zone de détection max. 4m de diamètre.
- Convertisseur non dimmable déporté fourni.

KORY R SENSOR		MATIÈRE	LED	T°	LED Lumen	System Lumen	€	
DO55005	<b>NEW</b>	NOIR MAT	ALU.+COMPOSITE	6W	2700-3000-4000K	775 Lm (4000K)	620 Lm (4000K)	44,90 A
DO55030	<b>NEW</b>	BLANC MAT	ALU.+COMPOSITE	6W	2700-3000-4000K	775 Lm (4000K)	665 Lm (4000K)	44,90 A



NOIR MAT



BLANC MAT



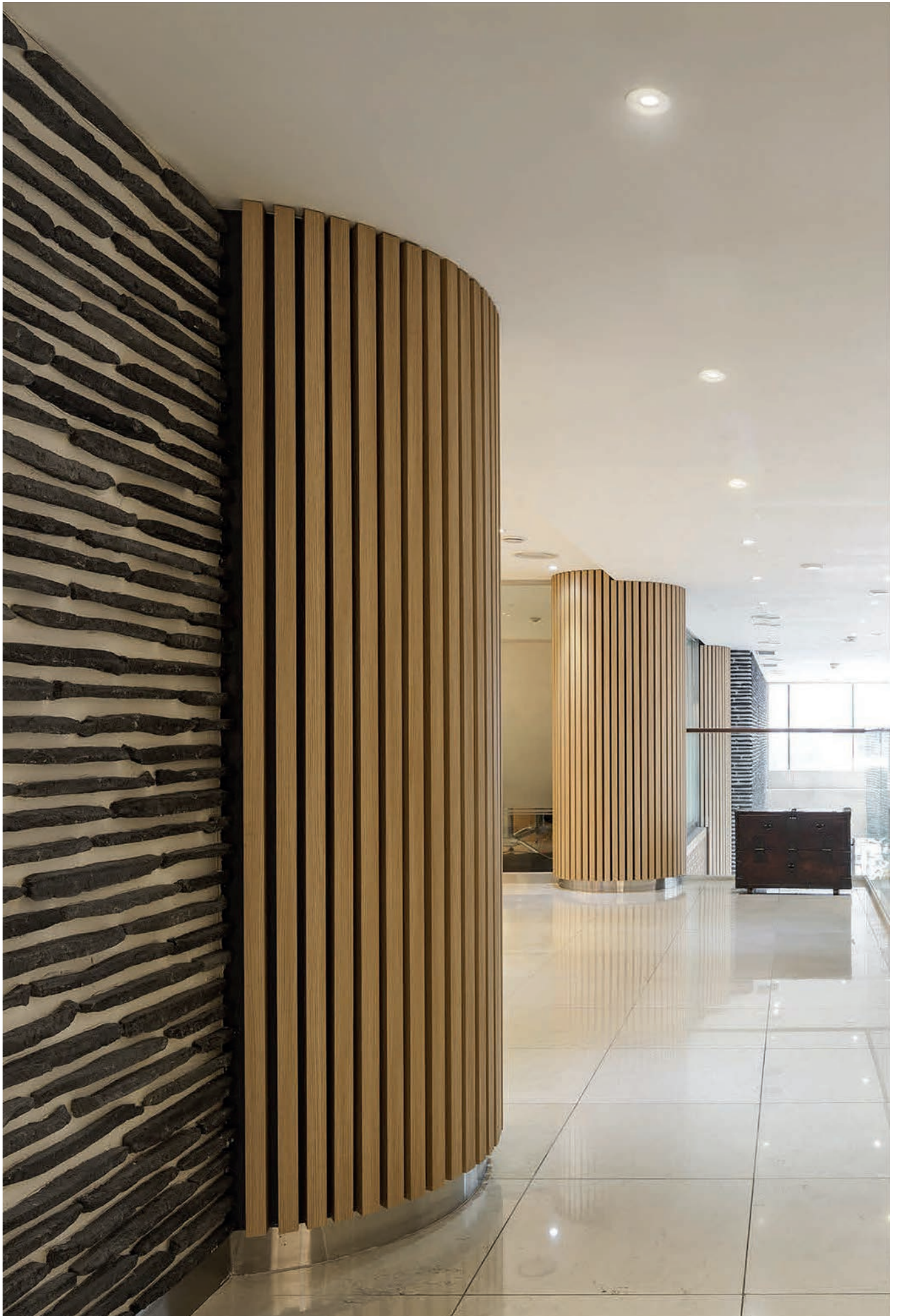

## BRAVA RD-230

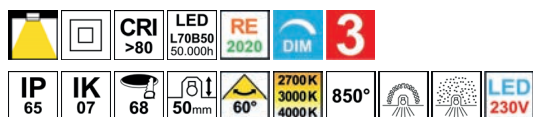

- Spot encastré rond fixe 3 en 1.
- 2700K, 3000K ou 4000K au choix via un interrupteur à l'arrière du luminaire.
- Fixation par ressorts.
- Peut être recouvert par un isolant déroulé ou soufflé.
- Double bornier automatique.
- Ne nécessite pas de convertisseur.
- Dimmable.
- Compatible avec variateur fin de phase.

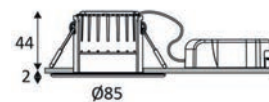

BRAVA RD-230		MATIÈRE	LED	T°	LED Lumen	System Lumen	€	
DO54405	<b>NEW</b>	NOIR MAT	ALU.+COMPOSITE	5W	2700-3000-4000K	680 Lm (4000K)	615 Lm (4000K)	26,00 B
DO54430	<b>NEW</b>	BLANC MAT	ALU.+COMPOSITE	5W	2700-3000-4000K	680 Lm (4000K)	615 Lm (4000K)	26,00 B



NOIR MAT



BLANC MAT





## BRAVA RDH-230

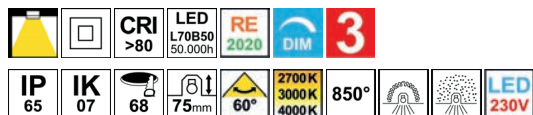

- Spot encastré rond fixe 3 en 1.
- 2700K, 3000K ou 4000K au choix via un interrupteur à l'arrière du luminaire.
- Réflecteur basse luminance.
- Fixation par ressorts.
- Peut être recouvert par un isolant déroulé ou soufflé.
- Double bornier automatique.
- Ne nécessite pas de convertisseur.
- Dimmable.
- Compatible avec variateur fin de phase.

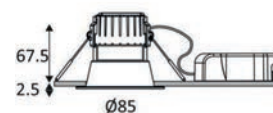

BRAVA RDH-230		MATIÈRE	LED	T°	LED Lumen	System Lumen	€
DO54505	<b>NEW</b> NOIR MAT	ALU.+COMPOSITE	5W	2700-3000-4000K	680 Lm (4000K)	400 Lm (4000K)	29,50 B
DO54530	<b>NEW</b> BLANC MAT	ALU.+COMPOSITE	5W	2700-3000-4000K	680 Lm (4000K)	555 Lm (4000K)	29,50 B



NOIR MAT



BLANC MAT



## H2 LITE SELECT

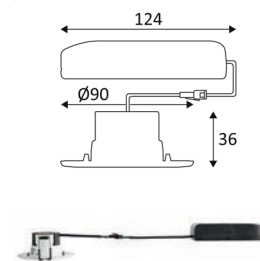
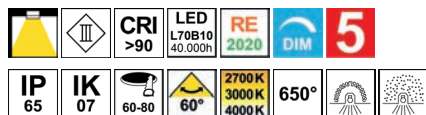

- Spot encastré rond fixe 3 en 1.
- 2700K, 3000K ou 4000K au choix via un interrupteur sur le convertisseur.
- Fixation par ressorts.
- Peut être recouvert par un isolant déroulé ou soufflé, convertisseur compris.
- Double bornier automatique.
- Convertisseur dimmable déporté fourni.
- Compatible avec variateur début et fin de phase.
- Bagues de finition interchangeables en option.
- Bagues couvrant un diamètre de perçage de 72 à 95mm (DLCVT110) ou de 70 à 150mm (DLCONVERT70) en option.

H2 LITE SELECT		MATIÈRE	LED	T°	LED Lumen	System Lumen	€
DL5485500	<b>NEW</b> BLANC MAT	ACIER+COMPOSITE	5,4W	2700-3000-4000K	625 Lm (4000K)	570 Lm (4000K)	32,60 A
ACCESSOIRES		MATIÈRE	DESCRIPTION		€		
RB359BLK	<b>NEW</b> NOIR MAT	COMPOSITE	BAGUE DE FINITION RONDE 90mm		5,10	A	
RB359BS	<b>NEW</b> ACIER BROSSÉ	COMPOSITE	BAGUE DE FINITION RONDE 90mm		5,10	A	
RB359CR	<b>NEW</b> CHROME	COMPOSITE	BAGUE DE FINITION RONDE 90mm		5,10	A	
RB359MW	<b>NEW</b> BLANC MAT	COMPOSITE	BAGUE DE FINITION RONDE 90mm		5,10	A	
RB359PG	<b>NEW</b> DORÉ	COMPOSITE	BAGUE DE FINITION RONDE 90mm		5,10	A	
RB359SIL	<b>NEW</b> ARGENT	COMPOSITE	BAGUE DE FINITION RONDE 90mm		5,10	A	
RB359WH	<b>NEW</b> BLANC BRILLANT	COMPOSITE	BAGUE DE FINITION RONDE 90mm		5,10	A	
SQB360BLK	<b>NEW</b> NOIR MAT	COMPOSITE	BAGUE DE FINITION CARREE 90x90mm		7,00	A	
SQB360MW	<b>NEW</b> BLANC MAT	COMPOSITE	BAGUE DE FINITION CARREE 90x90mm		7,00	A	
DLCVT110BLK	<b>NEW</b> NOIR MAT	ACIER	BAGUE DE MONTAGE 110mm		25,10	A	
DLCVT110BS	<b>NEW</b> ACIER BROSSÉ	ACIER	BAGUE DE MONTAGE 110mm		25,10	A	
DLCVT110MW	<b>NEW</b> BLANC MAT	ACIER	BAGUE DE MONTAGE 110mm		25,10	A	
DLCVT110WH	<b>NEW</b> BLANC BRILLANT	ACIER	BAGUE DE MONTAGE 110mm		25,10	A	
DLCONVERT70BS	<b>NEW</b> ACIER BROSSÉ	ACIER	BAGUE DE MONTAGE 170mm		25,10	A	
DLCONVERT70CR	<b>NEW</b> CHROME	ACIER	BAGUE DE MONTAGE 170mm		25,10	A	
DLCONVERT70MW	<b>NEW</b> BLANC MAT	ACIER	BAGUE DE MONTAGE 170mm		25,10	A	
DLCONVERT70WH	<b>NEW</b> BLANC BRILLANT	ACIER	BAGUE DE MONTAGE 170mm		25,10	A	



## H2 LITE CSP

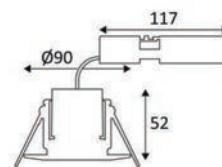
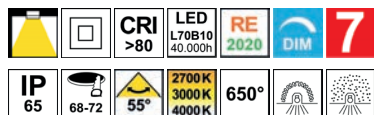

- Spot encastré rond fixe 6 en 1.
- 2700K, 3000K ou 4000K au choix via un interrupteur sous la bague de finition.
- Multi-puissance : 4,2 ou 6W au choix via un interrupteur sous la bague de finition.
- Fixation par ressorts.
- Peut être recouvert par un isolant déroulé ou soufflé, convertisseur compris.
- Double bornier automatique.
- Convertisseur dimmable déporté fourni.
- Bagues de finition interchangeables en option.
- Bagues couvrant un diamètre de perçage de 72 à 95mm (DLCVT110) ou de 70 à 150mm (DLCONVERT70) en option.

H2 LITE CSP	MATIÈRE	LED	T°	LED Lumen	System Lumen	€
<b>DLT551500A</b> <span style="background-color: yellow;">NEW</span> ■ BLANC MAT	ACIER+COMPOSITE	4,2W 6W	2700-3000-4000K	675 Lm (4000K) 950 Lm (4000K)	500 Lm (4000K) 700 Lm (4000K)	<b>35,00</b> A

ACCESSOIRES	MATIÈRE	DESCRIPTION	€
<b>RB359BLK</b> <span style="background-color: yellow;">NEW</span> ■ NOIR MAT	COMPOSITE	BAGUE DE FINITION RONDE 90mm	<b>5,10</b> A
<b>RB359BS</b> <span style="background-color: yellow;">NEW</span> ■ ACIER BROSSÉ	COMPOSITE	BAGUE DE FINITION RONDE 90mm	<b>5,10</b> A
<b>RB359CR</b> <span style="background-color: yellow;">NEW</span> ■ CHROME	COMPOSITE	BAGUE DE FINITION RONDE 90mm	<b>5,10</b> A
<b>RB359MW</b> <span style="background-color: yellow;">NEW</span> ■ BLANC MAT	COMPOSITE	BAGUE DE FINITION RONDE 90mm	<b>5,10</b> A
<b>RB359PG</b> <span style="background-color: yellow;">NEW</span> ■ DORÉ	COMPOSITE	BAGUE DE FINITION RONDE 90mm	<b>5,10</b> A
<b>RB359SIL</b> <span style="background-color: yellow;">NEW</span> ■ ARGENT	COMPOSITE	BAGUE DE FINITION RONDE 90mm	<b>5,10</b> A
<b>RB359WH</b> <span style="background-color: yellow;">NEW</span> ■ BLANC BRILLANT	COMPOSITE	BAGUE DE FINITION RONDE 90mm	<b>5,10</b> A
<b>SQB360BLK</b> <span style="background-color: yellow;">NEW</span> ■ NOIR MAT	COMPOSITE	BAGUE DE FINITION CARREE 90x90mm	<b>7,00</b> A
<b>SQB360MW</b> <span style="background-color: yellow;">NEW</span> ■ BLANC MAT	COMPOSITE	BAGUE DE FINITION CARREE 90x90mm	<b>7,00</b> A
<b>DLCVT110BLK</b> <span style="background-color: yellow;">NEW</span> ■ NOIR MAT	ACIER	BAGUE DE MONTAGE 110mm	<b>25,10</b> A
<b>DLCVT110BS</b> <span style="background-color: yellow;">NEW</span> ■ ACIER BROSSÉ	ACIER	BAGUE DE MONTAGE 110mm	<b>25,10</b> A
<b>DLCVT110MW</b> <span style="background-color: yellow;">NEW</span> ■ BLANC MAT	ACIER	BAGUE DE MONTAGE 110mm	<b>25,10</b> A
<b>DLCVT110WH</b> <span style="background-color: yellow;">NEW</span> ■ BLANC BRILLANT	ACIER	BAGUE DE MONTAGE 110mm	<b>25,10</b> A
<b>DLCONVERT70BS</b> <span style="background-color: yellow;">NEW</span> ■ ACIER BROSSÉ	ACIER	BAGUE DE MONTAGE 170mm	<b>25,10</b> A
<b>DLCONVERT70CR</b> <span style="background-color: yellow;">NEW</span> ■ CHROME	ACIER	BAGUE DE MONTAGE 170mm	<b>25,10</b> A
<b>DLCONVERT70MW</b> <span style="background-color: yellow;">NEW</span> ■ BLANC MAT	ACIER	BAGUE DE MONTAGE 170mm	<b>25,10</b> A
<b>DLCONVERT70WH</b> <span style="background-color: yellow;">NEW</span> ■ BLANC BRILLANT	ACIER	BAGUE DE MONTAGE 170mm	<b>25,10</b> A

## DEBI RD-230

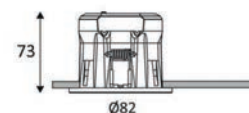
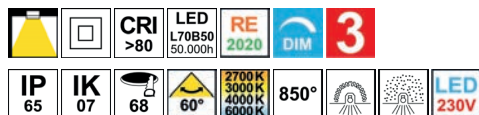

- Spot encastré rond fixe 4 en 1.
- 2700K, 3000K, 4000K ou 6000K au choix via un interrupteur à l'arrière du luminaire.
- Fixation par ressorts.
- Peut être recouvert par un isolant déroulé ou soufflé.
- Double bornier automatique.
- Ne nécessite pas de convertisseur.
- Dimmable.
- Compatible avec variateur fin de phase.

DEBI RD-230	MATIÈRE	LED	T°	LED Lumen	System Lumen	€	
DO44505	NOIR MAT	ALU.+COMPOSITE	5W	2700-3000-4000-6000K	620 Lm (4000K)	506 Lm (4000K)	28,80 B
DO44530	BLANC MAT	ALU.+COMPOSITE	5W	2700-3000-4000-6000K	620 Lm (4000K)	506 Lm (4000K)	28,80 B



NOIR MAT



BLANC MAT

## DEBI RD

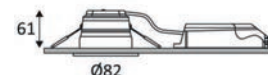
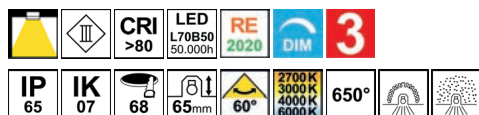

- Spot encastré rond fixe 4 en 1.
- 2700K, 3000K, 4000K ou 6000K au choix via un interrupteur à l'arrière du luminaire.
- Fixation par ressorts.
- Peut être recouvert par un isolant déroulé ou soufflé, convertisseur compris.
- Double bornier automatique.
- Convertisseur dimmable déporté fourni.
- Compatible avec variateur fin de phase.

DEBI RD	MATIÈRE	LED	T°	LED Lumen	System Lumen	€	
DO43005	NOIR MAT	ALU.+COMPOSITE	6W	2700-3000-4000-6000K	720 Lm (4000K)	570 Lm (4000K)	35,00 B
DO43030	BLANC MAT	ALU.+COMPOSITE	6W	2700-3000-4000-6000K	720 Lm (4000K)	570 Lm (4000K)	35,00 B



NOIR MAT



BLANC MAT



## IENA RDX-230



- Spot encastré rond orientable 4 en 1.
- 2700K, 3000K, 4000K ou 6000K au choix via un interrupteur à l'arrière du luminaire.
- Fixation par ressorts.
- Peut être recouvert par un isolant déroulé ou soufflé.
- Double bornier automatique.
- Ne nécessite pas de convertisseur.
- Dimmable.
- Compatible avec variateur fin de phase.

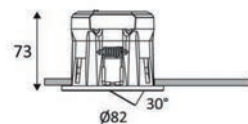

IENA RDX-230	MATIÈRE	LED	T°	LED Lumen	System Lumen	€
DO44605	NOIR MAT	ALU.+COMPOSITE	5W	2700-3000-4000-6000K	620 Lm (4000K)	506 Lm (4000K) 33,00 B
DO44630	BLANC MAT	ALU.+COMPOSITE	5W	2700-3000-4000-6000K	620 Lm (4000K)	506 Lm (4000K) 33,00 B



NOIR MAT



BLANC MAT

## IENA RDX

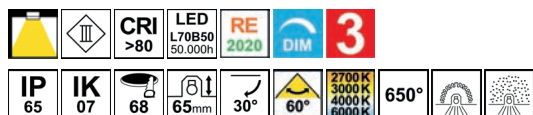

- Spot encastré rond orientable 4 en 1.
- 2700K, 3000K, 4000K ou 6000K au choix via un interrupteur à l'arrière du luminaire.
- Fixation par ressorts.
- Peut être recouvert par un isolant déroulé ou soufflé, convertisseur compris.
- Double bornier automatique.
- Convertisseur dimmable déporté fourni.
- Compatible avec variateur fin de phase.

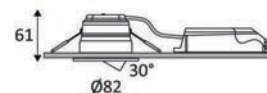

IENA RDX	MATIÈRE	LED	T°	LED Lumen	System Lumen	€
DO43105	NOIR MAT	ALU.+COMPOSITE	6W	2700-3000-4000-6000K	720 Lm (4000K)	570 Lm (4000K) 38,10 B
DO43130	BLANC MAT	ALU.+COMPOSITE	6W	2700-3000-4000-6000K	720 Lm (4000K)	570 Lm (4000K) 38,10 B



NOIR MAT



BLANC MAT





## BORA RDX-230

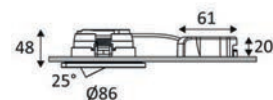
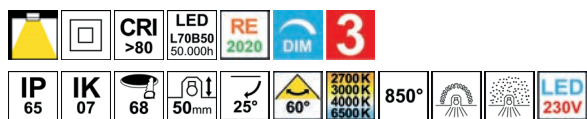

- Spot encastré rond orientable 4 en 1.
- 2700K, 3000K, 4000K ou 6500K au choix via un interrupteur à l'arrière du luminaire.
- Fixation par ressorts.
- Peut être recouvert par un isolant déroulé ou soufflé.
- Double bornier automatique.
- Ne nécessite pas de convertisseur.
- Dimmable.
- Compatible avec variateur fin de phase.

BORA RDX-230	MATIERE	LED	T°	LED Lumen	System Lumen	€
DO53705	NOIR MAT	ALU.+COMPOSITE	5W	2700-3000-4000-6500K	660 Lm (4000K)	590 Lm (4000K) 33,00 B
DO53721	NICKEL SATINE	ALU.+COMPOSITE	5W	2700-3000-4000-6500K	660 Lm (4000K)	590 Lm (4000K) 33,00 B
DO53730	BLANC MAT	ALU.+COMPOSITE	5W	2700-3000-4000-6500K	660 Lm (4000K)	590 Lm (4000K) 33,00 B



NOIR MAT



NICKEL SATINE



BLANC MAT





## BORA RDX

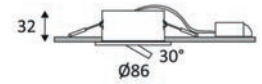
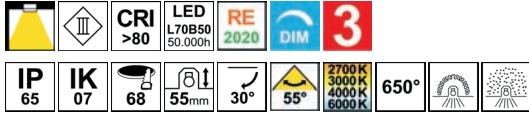

- Spot encastré rond orientable 4 en 1.
- 2700K, 3000K, 4000K ou 6000K au choix via un interrupteur sur le convertisseur.
- Fixation par ressorts.
- Peut être recouvert par un isolant déroulé ou soufflé, convertisseur compris.
- Double bornier automatique.
- Convertisseur dimmable déporté fourni.
- Compatible avec variateur fin de phase.

BORA RDX	MATÉRIE	LED	T°	LED Lumen	System Lumen	€
DO36105	NOIR MAT	ALU.+COMPOSITE	7W	2700-3000-4000-6000K	720 Lm (4000K)	600 Lm (4000K) 44,30 B
DO36121	NICKEL SATINE	ALU.+COMPOSITE	7W	2700-3000-4000-6000K	720 Lm (4000K)	600 Lm (4000K) 44,30 B
DO36130	BLANC MAT	ALU.+COMPOSITE	7W	2700-3000-4000-6000K	720 Lm (4000K)	600 Lm (4000K) 44,30 B



NOIR MAT



NICKEL SATINE



BLANC MAT

## BORA SDX

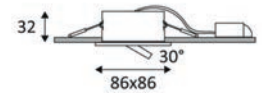
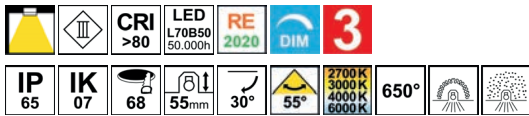

- Spot encastré carré orientable 4 en 1.
- 2700K, 3000K, 4000K ou 6000K au choix via un interrupteur sur le convertisseur.
- Fixation par ressorts.
- Peut être recouvert par un isolant déroulé ou soufflé, convertisseur compris.
- Double bornier automatique.
- Convertisseur dimmable déporté fourni.
- Compatible avec variateur fin de phase.

BORA SDX	MATÉRIE	LED	T°	LED Lumen	System Lumen	€
DO44005	NOIR MAT	ALU.+COMPOSITE	7W	2700-3000-4000-6000K	720 Lm (4000K)	600 Lm (4000K) 49,40 B
DO44021	NICKEL SATINE	ALU.+COMPOSITE	7W	2700-3000-4000-6000K	720 Lm (4000K)	600 Lm (4000K) 49,40 B
DO44030	BLANC MAT	ALU.+COMPOSITE	7W	2700-3000-4000-6000K	720 Lm (4000K)	600 Lm (4000K) 49,40 B



NOIR MAT



NICKEL SATINE



BLANC MAT

## ALEX RDX

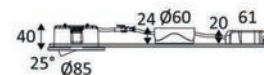
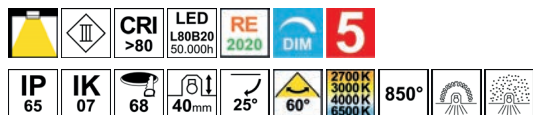

- Spot encastré rond orientable 4 en 1.
- 2700K, 3000K, 4000K ou 6500K au choix via un interrupteur sur le convertisseur.
- Fixation par ressorts.
- Peut être recouvert par un isolant déroulé ou soufflé, convertisseur compris.
- Double bornier automatique.
- Convertisseur dimmable déporté fourni.
- Compatible avec variateur début et fin de phase.
- Driver ou spot de remplacement disponibles séparément.

ALEX RDX	MATÉRIE	LED	T°	LED Lumen	System Lumen	€	
DO53305	■ NOIR MAT	ALU.+COMPOSITE	6W	2700-3000-4000-6500K	700 Lm (4000K)	575 Lm (4000K)	44,30 B
DO53321	■ NICKEL SATINE	ALU.+COMPOSITE	6W	2700-3000-4000-6500K	700 Lm (4000K)	575 Lm (4000K)	47,40 B
DO53330	■ BLANC MAT	ALU.+COMPOSITE	6W	2700-3000-4000-6500K	700 Lm (4000K)	575 Lm (4000K)	43,30 B

ACCESSOIRES	MATÉRIE	DESCRIPTION	€
LP53305	■ NOIR MAT	ALU.+COMPOSITE SPOT 6W 700Lm 60° IP65	17,50 B
LP53321	■ NICKEL SATINE	ALU.+COMPOSITE SPOT 6W 700Lm 60° IP65	20,60 B
LP53330	■ BLANC MAT	ALU.+COMPOSITE SPOT 6W 700Lm 60° IP65	16,50 B
CD533		DRIVER 6W 260mA CC DIM	23,70 B



NOIR MAT



NICKEL SATINE



BLANC MAT





## AL1014 RX

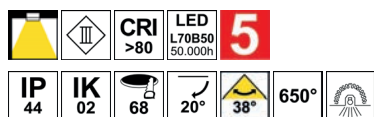

- Spot encastré rond orientable.
- Fixation par ressorts.
- Peut être recouvert par un isolant déroulé.
- Double bornier automatique.
- Convertisseur non dimmable déporté fourni.
- Bague couvrant un diamètre de perçage de 90 à 120mm à commander séparément.



AL1014 RX	MATIÈRE	LED	T°	LED Lumen	System Lumen	€
AL101425	ALUMINIUM	FONTE D'ALUMINIUM	6W	3000K	760 Lm	655 Lm 44,30 B
AL101430	BLANC MAT	FONTE D'ALUMINIUM	6W	3000K	760 Lm	655 Lm 44,30 B
DO11525	ALUMINIUM	FONTE D'ALUMINIUM	6W	4000K	820 Lm	705 Lm 49,40 B
DO11530	BLANC MAT	FONTE D'ALUMINIUM	6W	4000K	820 Lm	705 Lm 49,40 B

ACCESSOIRES	MATIÈRE	DESCRIPTION	€	
DO33330	BLANC MAT	ALUMINIUM	BAGUE DE MONTAGE 178mm	 18,50 B



ALUMINIUM



BLANC MAT

## AL1014 RDX

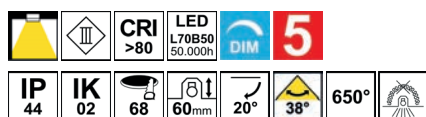

- Spot encastré rond orientable.
- Fixation par ressorts.
- Double bornier automatique.
- Convertisseur dimmable déporté fourni.
- Compatible avec variateur début et fin de phase.
- Bague couvrant un diamètre de perçage de 90 à 120mm à commander séparément.



AL1014 RDX	MATIÈRE	LED	T°	LED Lumen	System Lumen	€
DO16005	NOIR MAT	FONTE D'ALUMINIUM	9W	3000K	940 Lm	830 Lm 58,70 B
DO16025	ALUMINIUM	FONTE D'ALUMINIUM	9W	3000K	940 Lm	830 Lm 58,70 B
DO16030	BLANC MAT	FONTE D'ALUMINIUM	9W	3000K	940 Lm	830 Lm 51,50 B

ACCESSOIRES	MATIÈRE	DESCRIPTION	€	
DO33305	NOIR MAT	ALUMINIUM	BAGUE DE MONTAGE 178mm	 18,50 B
DO33330	BLANC MAT	ALUMINIUM	BAGUE DE MONTAGE 178mm	 18,50 B



NOIR MAT



ALUMINIUM



BLANC MAT



## AL2014 SDX

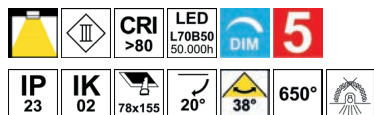

- Spot encastré rectangulaire orientable.
- Fixation par ressorts.
- Double bornier automatique.
- Convertisseur dimmable déporté fourni.
- Compatible avec variateur début et fin de phase.

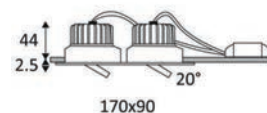

AL2014 SDX		MATIÈRE	LED	T°	LED Lumen	System Lumen	€	
DO18205	■	NOIR MAT	FONTE D'ALUMINIUM	2x9W	3000K	2x900 Lm	2x785 Lm	173,00 B
DO18230	■	BLANC MAT	FONTE D'ALUMINIUM	2x9W	3000K	2x900 Lm	2x785 Lm	173,00 B



NOIR MAT

BLANC MAT

## ALIS 1014 RDX

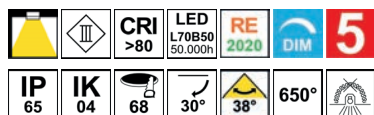

- Spot encastré rond orientable.
- Fixation par ressorts.
- Double bornier automatique.
- Avec membrane pour préserver l'étanchéité.
- Convertisseur dimmable déporté fourni.
- Compatible avec variateur début et fin de phase.

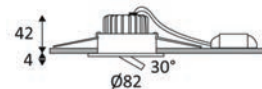

ALIS 1014 RDX		MATIÈRE	LED	T°	LED Lumen	System Lumen	€	
DO227WW05	■	NOIR MAT	FONTE D'ALUMINIUM	6W	3000K	740 Lm	675 Lm	72,10 B
DO227WW25	■	ALUMINIUM	FONTE D'ALUMINIUM	6W	3000K	740 Lm	675 Lm	98,90 B
DO227WW30	■	BLANC MAT	FONTE D'ALUMINIUM	6W	3000K	740 Lm	675 Lm	72,10 B
DO227NW05	■	NOIR MAT	FONTE D'ALUMINIUM	6W	4000K	800 Lm	730 Lm	72,10 B
DO227NW25	■	ALUMINIUM	FONTE D'ALUMINIUM	6W	4000K	800 Lm	730 Lm	98,90 B
DO227NW30	■	BLANC MAT	FONTE D'ALUMINIUM	6W	4000K	800 Lm	730 Lm	72,10 B



NOIR MAT

ALUMINIUM

BLANC MAT

## LARY RD

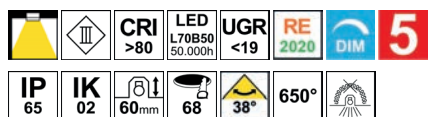

- Spot encastré rond fixe.
- Fixation par ressorts.
- Double bornier automatique.
- Convertisseur dimmable déporté fourni.
- Compatible avec variateur début et fin de phase.

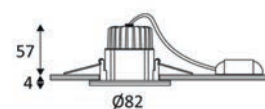

LARY RD	MATIERE	LED	T°	LED Lumen	System Lumen	€	
DO442WW05	NOIR MAT	FONTE D'ALUMINIUM	9W	3000K	1050 Lm	765 Lm	80,30 B
DO442WW21	NICKEL SATINE	FONTE D'ALUMINIUM	9W	3000K	1050 Lm	910 Lm	82,40 B
DO442WW30	BLANC MAT	FONTE D'ALUMINIUM	9W	3000K	1050 Lm	910 Lm	80,30 B
DO442NW05	NOIR MAT	FONTE D'ALUMINIUM	9W	4000K	1100 Lm	805 Lm	80,30 B
DO442NW21	NICKEL SATINE	FONTE D'ALUMINIUM	9W	4000K	1100 Lm	955 Lm	82,40 B
DO442NW30	BLANC MAT	FONTE D'ALUMINIUM	9W	4000K	1100 Lm	955 Lm	80,30 B



NOIR MAT



NICKEL SATINE



BLANC MAT

## LARY SD

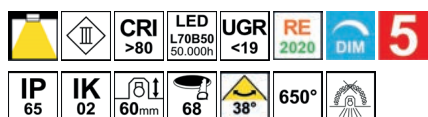

- Spot encastré carré fixe.
- Fixation par ressorts.
- Double bornier automatique.
- Convertisseur dimmable déporté fourni.
- Compatible avec variateur début et fin de phase.

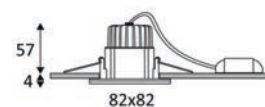

LARY SD	MATIERE	LED	T°	LED Lumen	System Lumen	€	
DO443WW05	NOIR MAT	FONTE D'ALUMINIUM	9W	3000K	1050 Lm	765 Lm	82,40 B
DO443WW21	NICKEL SATINE	FONTE D'ALUMINIUM	9W	3000K	1050 Lm	910 Lm	82,40 B
DO443WW30	BLANC MAT	FONTE D'ALUMINIUM	9W	3000K	1050 Lm	910 Lm	82,40 B
DO443NW05	NOIR MAT	FONTE D'ALUMINIUM	9W	4000K	1100 Lm	805 Lm	82,40 B
DO443NW21	NICKEL SATINE	FONTE D'ALUMINIUM	9W	4000K	1100 Lm	955 Lm	82,40 B
DO443NW30	BLANC MAT	FONTE D'ALUMINIUM	9W	4000K	1100 Lm	955 Lm	82,40 B



NOIR MAT



NICKEL SATINE



BLANC MAT





## IPHO 82 RD

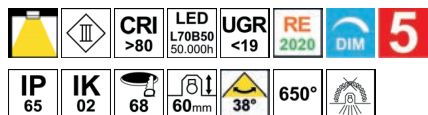

- Spot encastré rond fixe.
- Fixation par ressorts.
- Double bornier automatique.
- Convertisseur dimmable déporté fourni.
- Compatible avec variateur début et fin de phase.

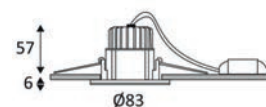

IPHO 82 RD	MATIERE	LED	T°	LED Lumen	System Lumen	€	
DO16405	NOIR	VERRE	9W	3000K	900 Lm	620 Lm	102,00 B
DO16430	BLANC	VERRE	9W	3000K	900 Lm	705 Lm	102,00 B



NOIR



BLANC



**IPHO R GU10 AUTO**  
DANS LA MÊME GAMME  
PAGE 35

## IPHO 82 SD

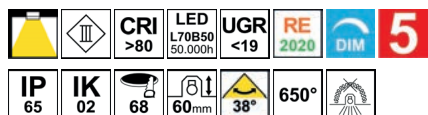

- Spot encastré carré fixe.
- Fixation par ressorts.
- Double bornier automatique.
- Convertisseur dimmable déporté fourni.
- Compatible avec variateur début et fin de phase.

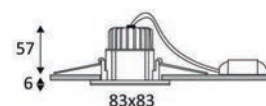

IPHO 82 SD	MATIERE	LED	T°	LED Lumen	System Lumen	€	
DO16505	NOIR	VERRE	9W	3000K	900 Lm	620 Lm	103,00 B
DO16530	BLANC	VERRE	9W	3000K	900 Lm	705 Lm	103,00 B



NOIR



BLANC



**IPHO S GU10 AUTO**  
DANS LA MÊME GAMME  
PAGE 35

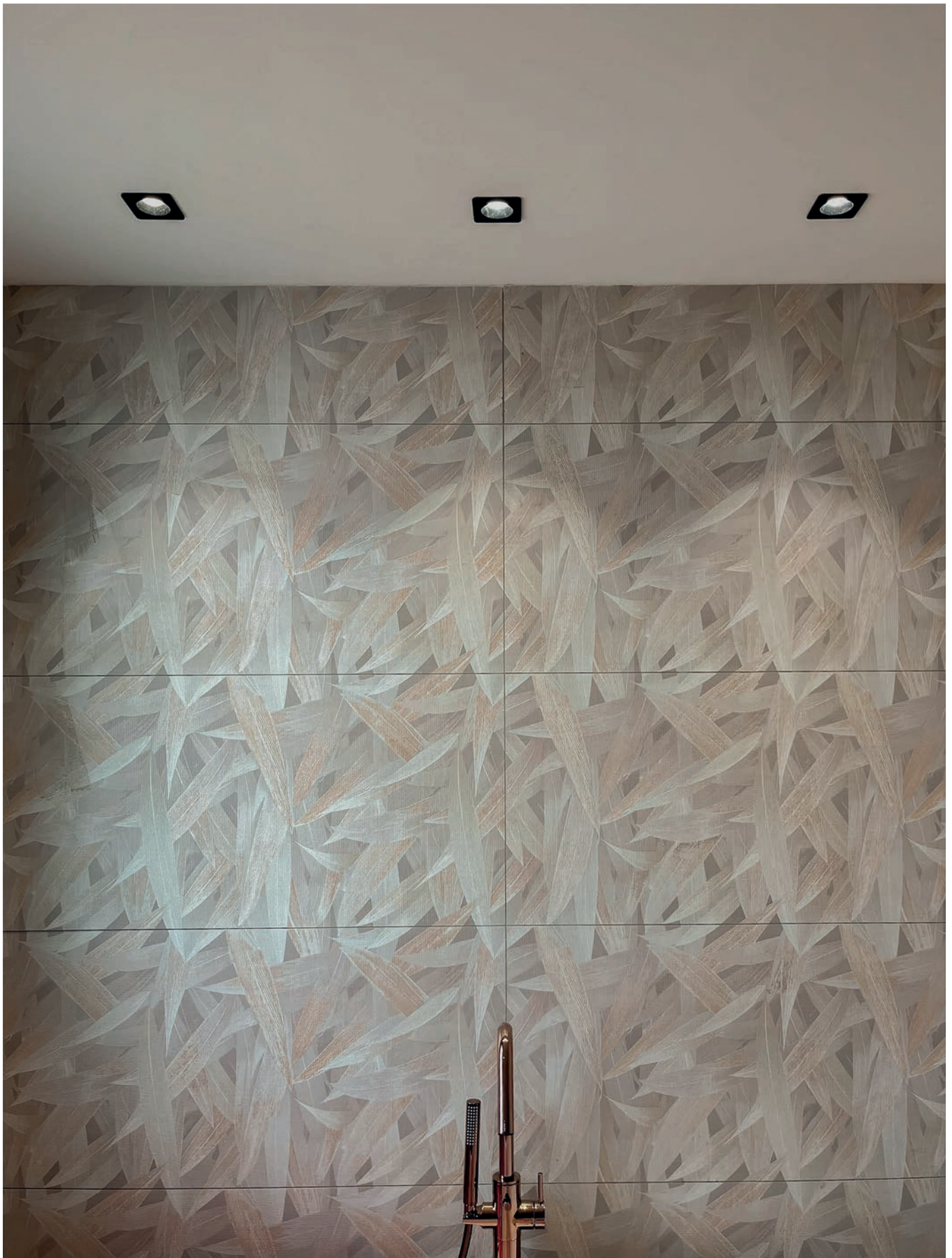

## MOWI RD

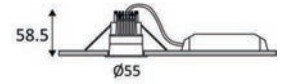
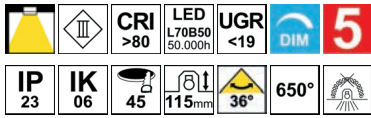

- Spot encastré rond fixe.
- Réflecteur basse luminance.
- Fixation par ressorts.
- Convertisseur dimmable déporté fourni.
- Compatible avec variateur début et fin de phase.



MOWI RD		MATIÈRE	LED	T°	LED Lumen	System Lumen	€
DO467WW05	■ NOIR MAT	FORTE D'ALUMINIUM	6W	3000K	550 Lm	295 Lm	69,00 B
DO467WW30	■ BLANC MAT	FORTE D'ALUMINIUM	6W	3000K	550 Lm	295 Lm	69,00 B



NOIR MAT

BLANC MAT





## COPE RD

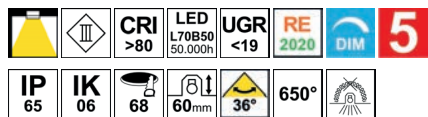

- Spot encastré rond fixe.
- Réflecteur basse luminance.
- Fixation par ressorts.
- Convertisseur dimmable déporté fourni.
- Compatible avec variateur début et fin de phase.

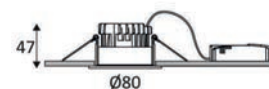

COPE RD	MATÉRIE	MATIÈRE	LED	T°	LED Lumen	System Lumen	€	
DO465WW05	■	NOIR MAT	FONTE D'ALUMINIUM	7W	3000K	750 Lm	621 Lm	74,20 B
DO465WW30	■	BLANC MAT	FONTE D'ALUMINIUM	7W	3000K	750 Lm	621 Lm	74,20 B
DO465NW05	■	NOIR MAT	FONTE D'ALUMINIUM	7W	4000K	800 Lm	644 Lm	74,20 B
DO465NW30	■	BLANC MAT	FONTE D'ALUMINIUM	7W	4000K	800 Lm	644 Lm	74,20 B



NOIR MAT



BLANC MAT

## EPI RD

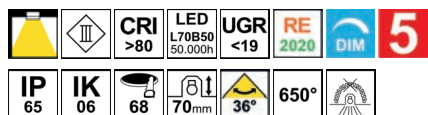

- Spot encastré rond fixe.
- Réflecteur basse luminance.
- Fixation par ressorts.
- Convertisseur dimmable déporté fourni.
- Compatible avec variateur début et fin de phase.

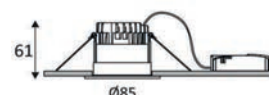

EPI RD	MATÉRIE	MATIÈRE	LED	T°	LED Lumen	System Lumen	€	
DO466WW05	■	NOIR MAT	FONTE D'ALUMINIUM	7W	3000K	750 Lm	571 Lm	79,30 B
DO466WW30	■	BLANC MAT	FONTE D'ALUMINIUM	7W	3000K	750 Lm	571 Lm	79,30 B
DO466NW05	■	NOIR MAT	FONTE D'ALUMINIUM	7W	4000K	800 Lm	599 Lm	79,30 B
DO466NW30	■	BLANC MAT	FONTE D'ALUMINIUM	7W	4000K	800 Lm	599 Lm	79,30 B



NOIR MAT



BLANC MAT

## SWEET RD

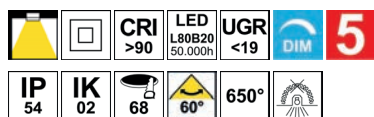

- Spot encastré rond fixe.
- Réflecteur basse luminance.
- Fixation par ressorts.
- Double bornier automatique.
- Convertisseur dimmable déporté fourni.
- Compatible avec variateur fin de phase.
- Bague couvrant un diamètre de perçage de 90 à 120mm à commander séparément.

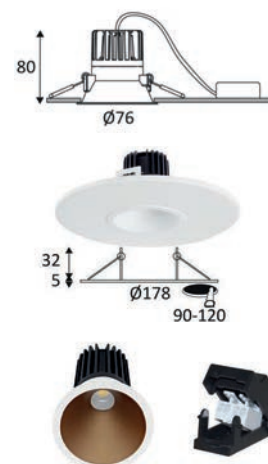

SWEET RD	MATIÈRE	LED	T°	LED Lumen	System Lumen	€	
DO448SW05	NOIR MAT	COMPOSITE	8W	2700K	600 Lm	365 Lm	50,00 B
DO448SW30	BLANC MAT	COMPOSITE	8W	2700K	600 Lm	449 Lm	50,00 B
DO448SW49	BLANC MAT - CHAMPAGNE	COMPOSITE	8W	2700K	600 Lm	449 Lm	50,00 B
DO448SW53	BLANC MAT - ARGENT	COMPOSITE	8W	2700K	600 Lm	449 Lm	50,00 B
DO448SW81	BLANC MAT - NOIR	COMPOSITE	8W	2700K	600 Lm	365 Lm	50,00 B
DO448WW05	NOIR MAT	COMPOSITE	8W	3000K	650 Lm	397 Lm	50,00 B
DO448WW30	BLANC MAT	COMPOSITE	8W	3000K	650 Lm	489 Lm	50,00 B
DO448WW49	BLANC MAT - CHAMPAGNE	COMPOSITE	8W	3000K	650 Lm	489 Lm	50,00 B
DO448WW53	BLANC MAT - ARGENT	COMPOSITE	8W	3000K	650 Lm	489 Lm	50,00 B
DO448WW81	BLANC MAT - NOIR	COMPOSITE	8W	3000K	650 Lm	397 Lm	50,00 B
DO448NW05	NOIR MAT	COMPOSITE	8W	4000K	700 Lm	430 Lm	50,00 B
DO448NW30	BLANC MAT	COMPOSITE	8W	4000K	700 Lm	528 Lm	50,00 B
DO448NW49	BLANC MAT - CHAMPAGNE	COMPOSITE	8W	4000K	700 Lm	528 Lm	50,00 B
DO448NW53	BLANC MAT - ARGENT	COMPOSITE	8W	4000K	700 Lm	528 Lm	50,00 B
DO448NW81	BLANC MAT - NOIR	COMPOSITE	8W	4000K	700 Lm	430 Lm	50,00 B

ACCESSOIRES	MATIÈRE	DESCRIPTION	€	
DO33305	NOIR MAT	ALUMINIUM	BAGUE DE MONTAGE 178mm	18,50 B
DO33330	BLANC MAT	ALUMINIUM	BAGUE DE MONTAGE 178mm	18,50 B



NOIR MAT



BLANC MAT



BLANC MAT -  
CHAMPAGNE



BLANC MAT -  
ARGENT



BLANC MAT - NOIR





# SILK RDX

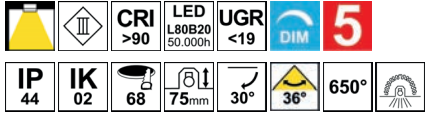

- Spot encastré rond orientable.
- Réflecteur basse luminance.
- Fixation par ressorts.
- Peut être recouvert par un isolant déroulé.
- Double bornier automatique.
- Convertisseur dimmable déporté fourni.
- Compatible avec variateur fin de phase.
- Bague couvrant un diamètre de perçage de 90 à 120mm à commander séparément.



SILK RDX	MATÉRIE	LED	T°	LED Lumen	System Lumen	€	
DO501WW05	NOIR MAT	FONTE D'ALUMINIUM	6W	3000K	630 Lm	490 Lm	64,90 B
DO501WW08	NOIR MAT - CHAMPAGNE	FONTE D'ALUMINIUM	6W	3000K	630 Lm	490 Lm	64,90 B
DO501WW17	NOIR MAT - ARGENT	FONTE D'ALUMINIUM	6W	3000K	630 Lm	490 Lm	65,90 B
DO501WW06	NOIR MAT - OR ROSE	FONTE D'ALUMINIUM	6W	3000K	630 Lm	490 Lm	65,90 B
DO501WW30	BLANC MAT	FONTE D'ALUMINIUM	6W	3000K	630 Lm	510 Lm	62,80 B
DO501WW49	BLANC MAT - CHAMPAGNE	FONTE D'ALUMINIUM	6W	3000K	630 Lm	510 Lm	65,90 B
DO501WW53	BLANC MAT - ARGENT	FONTE D'ALUMINIUM	6W	3000K	630 Lm	510 Lm	65,90 B
DO501WW02	BLANC MAT - OR ROSE	FONTE D'ALUMINIUM	6W	3000K	630 Lm	510 Lm	63,90 B

ACCESSOIRES	MATÉRIE	DESCRIPTION	€
DO33305	NOIR MAT	ALUMINIUM BAGUE DE MONTAGE 178mm	18,50 B
DO33330	BLANC MAT	ALUMINIUM BAGUE DE MONTAGE 178mm	18,50 B



NOIR MAT



NOIR MAT - CHAMPAGNE



NOIR MAT - ARGENT



NOIR MAT - OR ROSE



BLANC MAT



BLANC MAT - CHAMPAGNE



BLANC MAT - ARGENT



BLANC MAT - OR ROSE

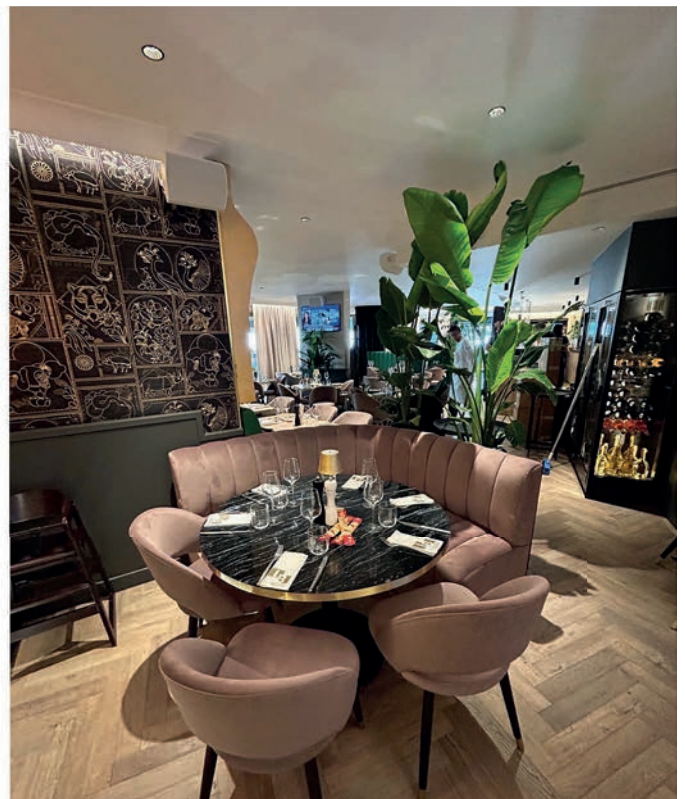





## SILK RDX WARM

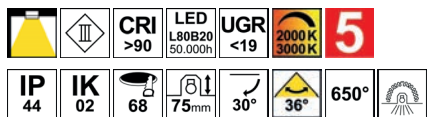

- Spot encastré rond orientable.
- Réflecteur basse luminance.
- Fixation par ressorts.
- Peut être recouvert par un isolant déroulé.
- Double bornier automatique.
- Température de couleur variable de 2000K à 3000K suivant l'intensité de dimming.
- Convertisseur dimmable déporté fourni.
- Compatible avec variateur fin de phase.
- Bague couvrant un diamètre de perçage de 90 à 120mm à commander séparément.

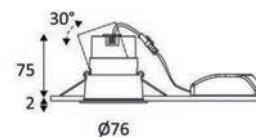

SILK RDX WARM	MATÉRIE	LED	T°	LED Lumen	System Lumen	€	
DO50205	NOIR MAT	FONTE D'ALUMINIUM	6W	2000-3000K	530 Lm (3000K)	410 Lm (3000K)	62,80 B
DO50208	NOIR MAT - CHAMPAGNE	FONTE D'ALUMINIUM	6W	2000-3000K	530 Lm (3000K)	410 Lm (3000K)	65,90 B
DO50217	NOIR MAT - ARGENT	FONTE D'ALUMINIUM	6W	2000-3000K	530 Lm (3000K)	410 Lm (3000K)	65,90 B
DO50206	NOIR MAT - OR ROSE	FONTE D'ALUMINIUM	6W	2000-3000K	530 Lm (3000K)	410 Lm (3000K)	65,90 B
DO50230	BLANC MAT	FONTE D'ALUMINIUM	6W	2000-3000K	530 Lm (3000K)	430 Lm (3000K)	62,80 B
DO50249	BLANC MAT - CHAMPAGNE	FONTE D'ALUMINIUM	6W	2000-3000K	530 Lm (3000K)	430 Lm (3000K)	65,90 B
DO50253	BLANC MAT - ARGENT	FONTE D'ALUMINIUM	6W	2000-3000K	530 Lm (3000K)	430 Lm (3000K)	65,90 B
DO50202	BLANC MAT - OR ROSE	FONTE D'ALUMINIUM	6W	2000-3000K	530 Lm (3000K)	430 Lm (3000K)	65,90 B

ACCESSOIRES	MATÉRIE	DESCRIPTION	€	
DO33305	NOIR MAT	ALUMINIUM	BAGUE DE MONTAGE 178mm	18,50 B
DO33330	BLANC MAT	ALUMINIUM	BAGUE DE MONTAGE 178mm	18,50 B



NOIR MAT



NOIR MAT - CHAMPAGNE



NOIR MAT - ARGENT



NOIR MAT - OR ROSE



BLANC MAT



BLANC MAT - CHAMPAGNE



BLANC MAT - ARGENT



BLANC MAT - OR ROSE

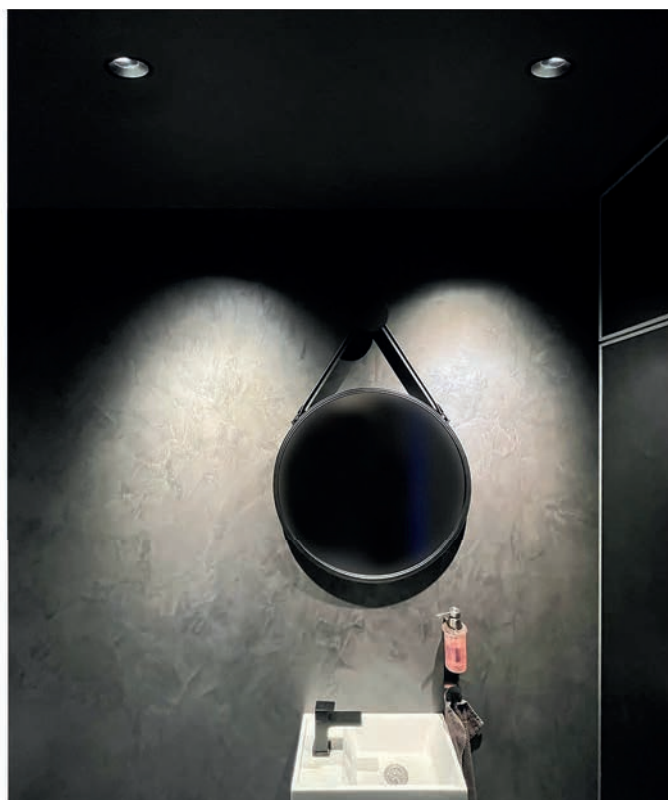

### AL3012 RD

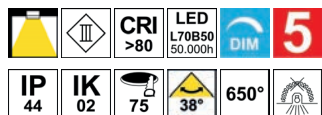

- Spot encastré rond fixe.
- Réflecteur basse luminance.
- Fixation par ressorts.
- Convertisseur dimmable déporté fourni.
- Compatible avec variateur début et fin de phase.

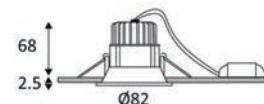

AL3012 RD		MATIÈRE	LED	T°	LED Lumen	System Lumen	€
DO17105	■ NOIR MAT	FONTE D'ALUMINIUM	9W	3000K	1050 Lm	820 Lm	81,00 B
DO17130	■ BLANC MAT	FONTE D'ALUMINIUM	9W	3000K	1050 Lm	867 Lm	81,00 B
DO17144	■ BLANC MAT - DORE	FONTE D'ALUMINIUM	9W	3000K	1050 Lm	867 Lm	90,00 B



NOIR MAT



BLANC MAT



BLANC MAT - DORE

### AL3012 RD WARM

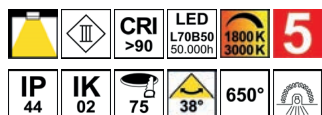

- Spot encastré rond fixe.
- Réflecteur basse luminance.
- Fixation par ressorts.
- Peut être recouvert par un isolant déroulé.
- Température de couleur variable de 1800K à 3000K suivant l'intensité de dimming.
- Convertisseur dimmable déporté fourni.
- Compatible avec variateur début et fin de phase.

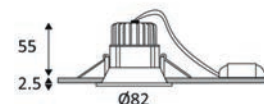

AL3012 RD WARM		MATIÈRE	LED	T°	LED Lumen	System Lumen	€
DO33005	■ NOIR MAT	FONTE D'ALUMINIUM	6W	1800-3000K	530 Lm (3000K)	405 Lm (3000K)	109,20 B
DO33030	■ BLANC MAT	FONTE D'ALUMINIUM	6W	1800-3000K	530 Lm (3000K)	425 Lm (3000K)	109,20 B



NOIR MAT



BLANC MAT



## SYLA RD-B

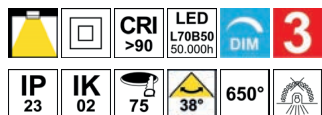

- Spot encastré rond fixe.
- Réflecteur basse luminance.
- Fixation par lamelles.
- Convertisseur dimmable déporté fourni.

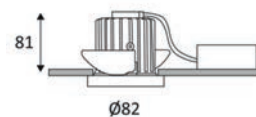

SYLA RD-B		MATIÈRE	LED	T°	LED Lumen	System Lumen	€		
DO221SW05		NOIR MAT	FONTE D'ALUMINIUM	10W	2700K	960 Lm	776 Lm	95,00	B
DO221SW18		NOIR - DORE	FONTE D'ALUMINIUM	10W	2700K	960 Lm	776 Lm	114,00	B
DO221SW30		BLANC MAT	FONTE D'ALUMINIUM	10W	2700K	960 Lm	776 Lm	95,00	B
DO221WW05		NOIR MAT	FONTE D'ALUMINIUM	10W	3000K	1010 Lm	851 Lm	95,00	B
DO221WW18		NOIR - DORE	FONTE D'ALUMINIUM	10W	3000K	1010 Lm	851 Lm	115,00	B
DO221WW30		BLANC MAT	FONTE D'ALUMINIUM	10W	3000K	1010 Lm	851 Lm	95,00	B

ACCESSOIRES		DESCRIPTION		€	
DO33905		SYLA RD-B BAGUE CARREE 100x100mm		15,50	B
DO33930		SYLA RD-B BAGUE CARREE 100x100mm		15,50	B
DO34005		SYLA RD-B BAGUE RECTANGULAIRE 195x100mm		33,00	B
DO34030		SYLA RD-B BAGUE RECTANGULAIRE 195x100mm		33,00	B



NOIR MAT



NOIR - DORE



BLANC MAT



## ABY 1 RD

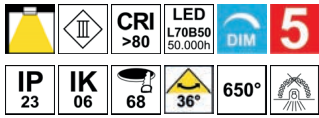

- Spot encastré rond fixe.
- Réflecteur basse luminance.
- Fixation par ressorts.
- Convertisseur dimmable déporté fourni.
- Compatible avec variateur début et fin de phase.

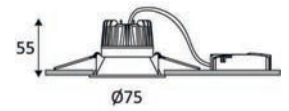

ABY 1 RD		MATIÈRE	LED	T°	LED Lumen	System Lumen	€
DO461WW05	■ NOIR MAT	FONTE D'ALUMINIUM	6,5W	3000K	550 Lm	519 Lm	69,00 B
DO461WW30	■ BLANC MAT	FONTE D'ALUMINIUM	6,5W	3000K	550 Lm	519 Lm	69,00 B
DO461NW05	■ NOIR MAT	FONTE D'ALUMINIUM	6,5W	4000K	800 Lm	600 Lm	69,00 B
DO461NW30	■ BLANC MAT	FONTE D'ALUMINIUM	6,5W	4000K	800 Lm	600 Lm	69,00 B



NOIR MAT



BLANC MAT





## ABY 2 RD

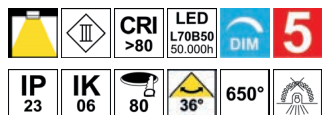

- Spot encastré rond fixe.
- Réflecteur basse luminance.
- Fixation par ressorts.
- Convertisseur dimmable déporté fourni.
- Compatible avec variateur début et fin de phase.

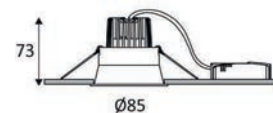

ABY 2 RD		MATIÈRE	LED	T°	LED Lumen	System Lumen	€	
DO462WW05	■	NOIR MAT	FONTE D'ALUMINIUM	9W	3000K	750 Lm	680 Lm	79,30 B
DO462WW30	■	BLANC MAT	FONTE D'ALUMINIUM	9W	3000K	750 Lm	680 Lm	79,30 B
DO462NW05	■	NOIR MAT	FONTE D'ALUMINIUM	9W	4000K	950 Lm	860 Lm	79,30 B
DO462NW30	■	BLANC MAT	FONTE D'ALUMINIUM	9W	4000K	950 Lm	860 Lm	79,30 B



NOIR MAT



BLANC MAT

## ABY 3 RD

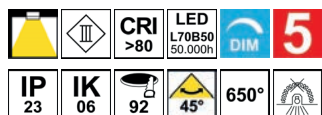

- Spot encastré rond fixe.
- Réflecteur basse luminance.
- Fixation par ressorts.
- Convertisseur dimmable déporté fourni.
- Compatible avec variateur début et fin de phase.

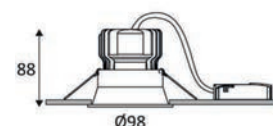

ABY 3 RD		MATIÈRE	LED	T°	LED Lumen	System Lumen	€	
DO464WW05	■	NOIR MAT	FONTE D'ALUMINIUM	15W	3000K	1300 Lm	1151 Lm	103,00 B
DO464WW30	■	BLANC MAT	FONTE D'ALUMINIUM	15W	3000K	1300 Lm	1151 Lm	103,00 B
DO464NW05	■	NOIR MAT	FONTE D'ALUMINIUM	15W	4000K	1700 Lm	1447 Lm	103,00 B
DO464NW30	■	BLANC MAT	FONTE D'ALUMINIUM	15W	4000K	1700 Lm	1447 Lm	103,00 B



NOIR MAT



BLANC MAT

## RONGA 1 RDX-B

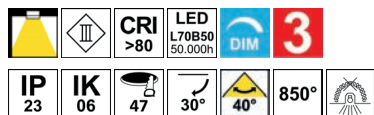

- Spot encastré rond orientable.
- Fixation par lamelles.
- Convertisseur dimmable déporté fourni.
- Compatible avec variateur début et fin de phase.
- Bagues décoratives à commander séparément.

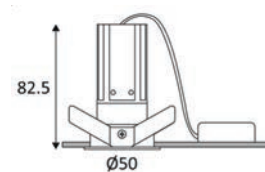

RONGA 1 RDX-B	MATIERE	LED	T°	LED Lumen	System Lumen	€	
DO469WW05	■ NOIR MAT	FONTE D'ALUMINIUM	7W	3000K	590 Lm	385 Lm	65,90 B
DO469WW30	■ BLANC MAT	FONTE D'ALUMINIUM	7W	3000K	590 Lm	385 Lm	65,90 B
DO469NW05	■ NOIR MAT	FONTE D'ALUMINIUM	7W	4000K	670 Lm	408 Lm	65,90 B
DO469NW30	■ BLANC MAT	FONTE D'ALUMINIUM	7W	4000K	670 Lm	408 Lm	65,90 B

ACCESSOIRES	DESCRIPTION	€	
DO48025	■ ARGENT	BAGUE DECORATIVE	4,10 B
DO48060	■ DORE	BAGUE DECORATIVE	3,10 B



NOIR MAT

BLANC MAT

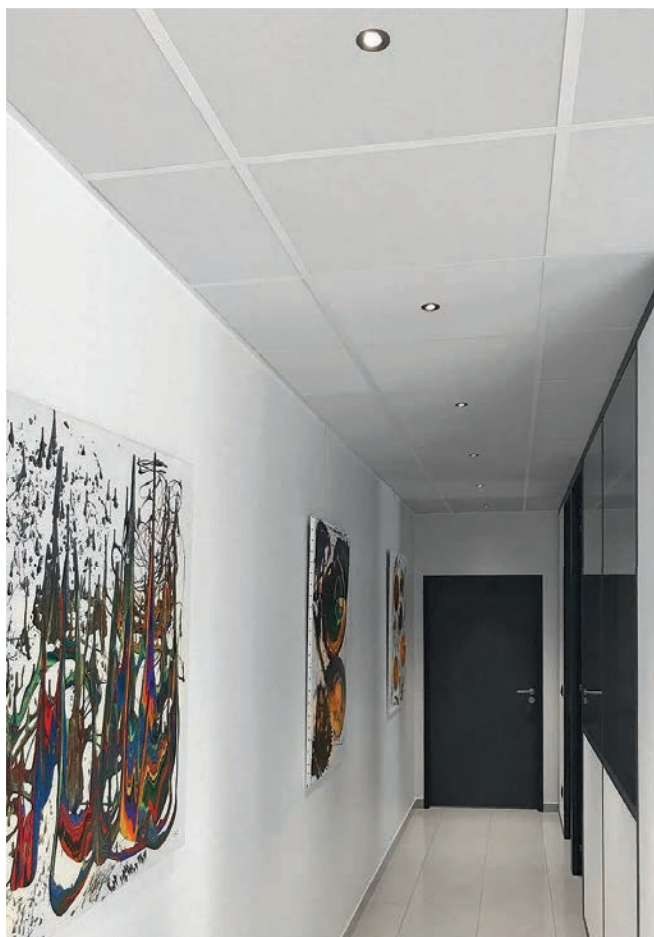



## RONGA 2 RDX-B

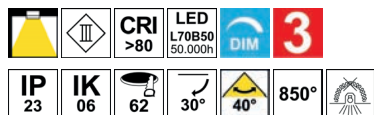

- Spot encastré rond orientable.
- Fixation par lamelles.
- Convertisseur dimmable déporté fourni.
- Compatible avec variateur début et fin de phase.
- Bagues décoratives à commander séparément.

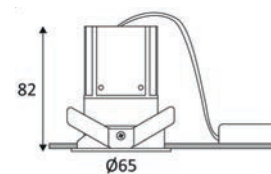

RONGA 2 RDX-B	MATIÈRE	LED	T°	LED Lumen	System Lumen	€
DO470WW05	NOIR MAT	FONTE D'ALUMINIUM	9W	3000K	980 Lm	527 Lm 74,20 B
DO470WW30	BLANC MAT	FONTE D'ALUMINIUM	9W	3000K	980 Lm	527 Lm 74,20 B
DO470NW05	NOIR MAT	FONTE D'ALUMINIUM	9W	4000K	1070 Lm	793 Lm 74,20 B
DO470NW30	BLANC MAT	FONTE D'ALUMINIUM	9W	4000K	1070 Lm	793 Lm 74,20 B

ACCESSOIRES	DESCRIPTION	€
DO48125	ARGENT	BAGUE DECORATIVE 4,10 B
DO48160	DORE	BAGUE DECORATIVE 3,10 B



NOIR MAT



BLANC MAT

## RONGA 3 RDX-B

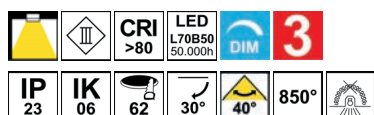

- Spot encastré rond orientable.
- Fixation par lamelles.
- Convertisseur dimmable déporté fourni.
- Compatible avec variateur début et fin de phase.
- Bagues décoratives à commander séparément.

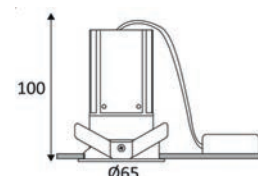

RONGA 3 RDX-B	MATIÈRE	LED	T°	LED Lumen	System Lumen	€
DO471WW05	NOIR MAT	FONTE D'ALUMINIUM	12W	3000K	1160 Lm	656 Lm 90,60 B
DO471WW30	BLANC MAT	FONTE D'ALUMINIUM	12W	3000K	1160 Lm	656 Lm 90,60 B
DO471NW05	NOIR MAT	FONTE D'ALUMINIUM	12W	4000K	1240 Lm	888 Lm 90,60 B
DO471NW30	BLANC MAT	FONTE D'ALUMINIUM	12W	4000K	1240 Lm	888 Lm 90,60 B

ACCESSOIRES	DESCRIPTION	€
DO48225	ARGENT	BAGUE DECORATIVE 4,10 B
DO48260	DORE	BAGUE DECORATIVE 3,10 B



NOIR MAT



BLANC MAT

## JADE RDX

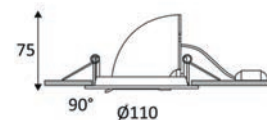
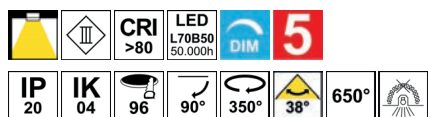

- Spot encastré rond orientable.
- Fixation par ressorts.
- Convertisseur dimmable déporté fourni.
- Compatible avec variateur début et fin de phase.
- En option, convertisseur dimmable DALI-PUSH CD140 à commander séparément.

ALIMENTATION(S)	Watt Max	€
CD140	3-18W	100,90 B

JADE RDX	MATIERE	LED	T°	LED Lumen	System Lumen	€	
DO272WW05	■ NOIR MAT	FONTE D'ALUMINIUM	12W	3000K	1400 Lm	1000 Lm	138,00 B
DO272WW30	■ BLANC MAT	FONTE D'ALUMINIUM	12W	3000K	1400 Lm	1000 Lm	138,00 B
DO272NW05	■ NOIR MAT	FONTE D'ALUMINIUM	12W	4000K	1450 Lm	1030 Lm	138,00 B
DO272NW30	■ BLANC MAT	FONTE D'ALUMINIUM	12W	4000K	1450 Lm	1030 Lm	138,00 B



NOIR MAT

BLANC MAT







## ALLY 3 RDX

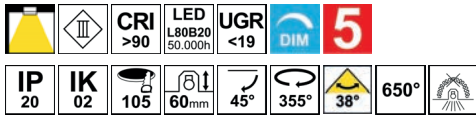

- Spot encastré rond orientable.
- Fixation par ressorts.
- Convertisseur dimmable déporté fourni.
- Compatible avec variateur début et fin de phase.
- En option, convertisseur dimmable DALI-PUSH CD123 à commander séparément.

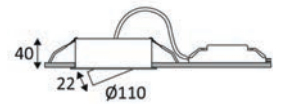

ALIMENTATION(S)	Watt Max	€
CD123	3-18W	87,60 B

ALLY 3 RDX	MATIÈRE	LED	T°	LED Lumen	System Lumen	€	
DO529WW05	NOIR MAT	ALUMINIUM	10W	3000K	1025 Lm	715 Lm	126,70 B
DO529WW30	BLANC MAT	ALUMINIUM	10W	3000K	1025 Lm	715 Lm	126,70 B



NOIR MAT



BLANC MAT



### ALLY 1 RDX

DANS LA MÊME GAMME  
PAGE 100

## ALLY 4 RDX

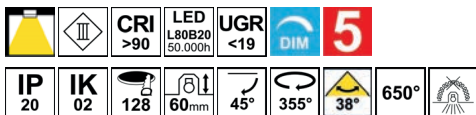

- Spot encastré rond orientable.
- Fixation par ressorts.
- Convertisseur dimmable déporté fourni.
- Compatible avec variateur début et fin de phase.
- En option, convertisseur dimmable DALI-PUSH CD140 à commander séparément.

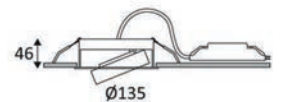

ALIMENTATION(S)	Watt Max	€
CD140	3-18W	100,90 B

ALLY 4 RDX	MATIÈRE	LED	T°	LED Lumen	System Lumen	€	
DO530WW05	NOIR MAT	ALUMINIUM	14W	3000K	1270 Lm	925 Lm	146,30 B
DO530WW30	BLANC MAT	ALUMINIUM	14W	3000K	1270 Lm	925 Lm	146,30 B



NOIR MAT



BLANC MAT



### ALLY 2 RDX

DANS LA MÊME GAMME  
PAGE 102

### AL1015 RX

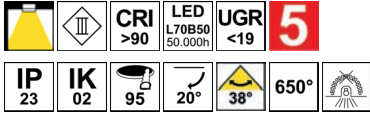

- Spot encastré rond orientable.
- Fixation par ressorts.
- Convertisseur non dimmable déporté fourni.
- En option, convertisseur dimmable DALI-PUSH CD140 à commander séparément.

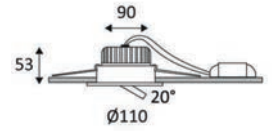

ALIMENTATION(S)	Watt Max	€
CD140	3-18W	100,90 B

AL1015 RX	MATIÈRE	LED	T°	LED Lumen	System Lumen	€	
DO108WW05	NOIR MAT	FONTE D'ALUMINIUM	12W	3000K	1100 Lm	915 Lm	126,70 B
DO108WW21	NICKEL SATINE	FONTE D'ALUMINIUM	12W	3000K	1100 Lm	915 Lm	126,70 B
AL1015WW30	BLANC MAT	FONTE D'ALUMINIUM	12W	3000K	1100 Lm	915 Lm	126,70 B
DO108NW05	NOIR MAT	FONTE D'ALUMINIUM	12W	4000K	1200 Lm	1000 Lm	126,70 B
DO108NW21	NICKEL SATINE	FONTE D'ALUMINIUM	12W	4000K	1200 Lm	1000 Lm	126,70 B
DO108NW30	BLANC MAT	FONTE D'ALUMINIUM	12W	4000K	1200 Lm	1000 Lm	126,70 B



### AL1015 SX

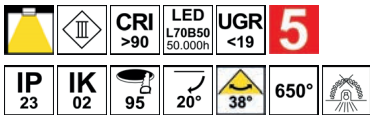

- Spot encastré carré orientable.
- Fixation par ressorts.
- Convertisseur non dimmable déporté fourni.
- En option, convertisseur dimmable DALI-PUSH CD140 à commander séparément.

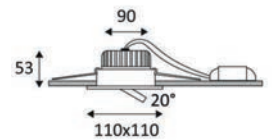

ALIMENTATION(S)	Watt Max	€
CD140	3-18W	100,90 B

AL1015 SX	MATIÈRE	LED	T°	LED Lumen	System Lumen	€	
DO109WW30	BLANC MAT	FONTE D'ALUMINIUM	12W	3000K	1100 Lm	915 Lm	126,70 B
DO109NW30	BLANC MAT	FONTE D'ALUMINIUM	12W	4000K	1200 Lm	1000 Lm	126,70 B



**DOTS**

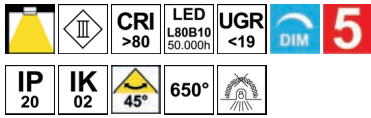

- Spot encastré pour éclairage d'accentuation.
- Réflecteur basse luminance.
- Fixation par ressorts.
- Convertisseur dimmable déporté fourni.
- DO497, DO498 et DO499 en version DALI : convertisseur avec fonction push-dim.

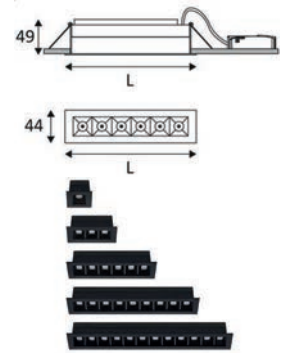

DOTS		MATIÈRE	LED	T°	LED Lumen	System Lumen	L (mm)	€			
<b>DIMMABLE COUPURE DE PHASE</b>											
		<b>DO500WW05</b>	NOIR MAT	ALUMINIUM	3W	3000K	320 Lm	148 Lm	48	<b>44,30</b>	B
		<b>DO500WW30</b>	BLANC MAT	ALUMINIUM	3W	3000K	320 Lm	148 Lm	48	<b>44,30</b>	B
		<b>DO496WW05</b>	NOIR MAT	ALUMINIUM	6W	3000K	470 Lm	345 Lm	102	<b>53,60</b>	B
		<b>DO496WW30</b>	BLANC MAT	ALUMINIUM	6W	3000K	470 Lm	345 Lm	102	<b>53,60</b>	B
		<b>DO497WW05</b>	NOIR MAT	ALUMINIUM	12W	3000K	940 Lm	609 Lm	182	<b>79,30</b>	B
		<b>DO497WW30</b>	BLANC MAT	ALUMINIUM	12W	3000K	940 Lm	609 Lm	182	<b>79,30</b>	B
		<b>DO498WW05</b>	NOIR MAT	ALUMINIUM	16W	3000K	1400 Lm	1011 Lm	262	<b>102,00</b>	B
		<b>DO498WW30</b>	BLANC MAT	ALUMINIUM	16W	3000K	1400 Lm	1011 Lm	262	<b>102,00</b>	B
		<b>DO499WW05</b>	NOIR MAT	ALUMINIUM	20W	3000K	1880 Lm	1217 Lm	342	<b>116,40</b>	B
		<b>DO499WW30</b>	BLANC MAT	ALUMINIUM	20W	3000K	1880 Lm	1217 Lm	342	<b>116,40</b>	B
<b>DIMMABLE DALI</b>											
		<b>DO500WW05DA</b>	NOIR MAT	ALUMINIUM	3W	3000K	320 Lm	148 Lm	48	<b>131,80</b>	B
		<b>DO500WW30DA</b>	BLANC MAT	ALUMINIUM	3W	3000K	320 Lm	148 Lm	48	<b>131,80</b>	B
		<b>DO496WW05DA</b>	NOIR MAT	ALUMINIUM	6W	3000K	470 Lm	345 Lm	102	<b>117,40</b>	B
		<b>DO496WW30DA</b>	BLANC MAT	ALUMINIUM	6W	3000K	470 Lm	345 Lm	102	<b>117,40</b>	B
		<b>DO497WW05DA</b>	NOIR MAT	ALUMINIUM	12W	3000K	940 Lm	609 Lm	182	<b>191,60</b>	B
		<b>DO497WW30DA</b>	BLANC MAT	ALUMINIUM	12W	3000K	940 Lm	609 Lm	182	<b>191,60</b>	B
		<b>DO498WW05DA</b>	NOIR MAT	ALUMINIUM	16W	3000K	1400 Lm	1011 Lm	262	<b>205,00</b>	B
		<b>DO498WW30DA</b>	BLANC MAT	ALUMINIUM	16W	3000K	1400 Lm	1011 Lm	262	<b>205,00</b>	B
		<b>DO499WW05DA</b>	NOIR MAT	ALUMINIUM	20W	3000K	1880 Lm	1217 Lm	342	<b>225,60</b>	B
		<b>DO499WW30DA</b>	BLANC MAT	ALUMINIUM	20W	3000K	1880 Lm	1217 Lm	342	<b>225,60</b>	B



**DOTS C**  
DANS LA MÊME GAMME  
PAGE 211

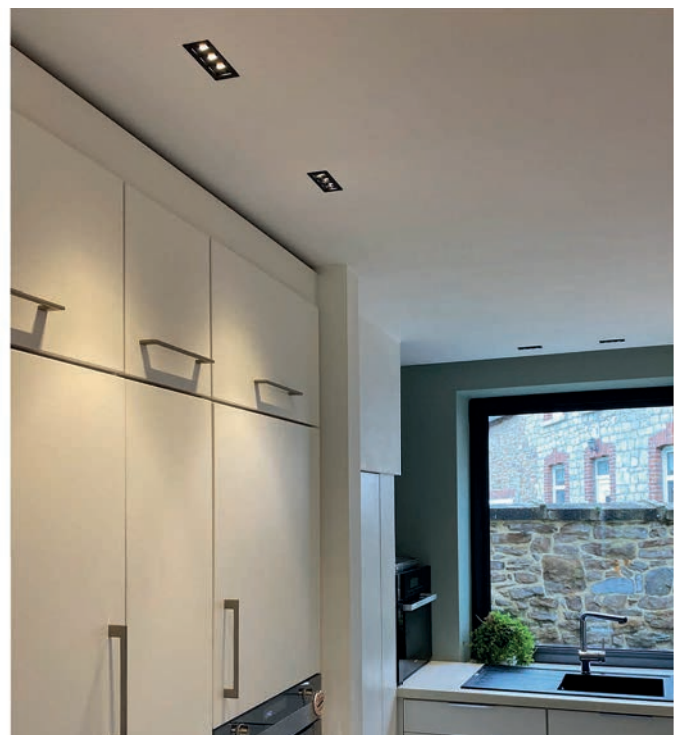

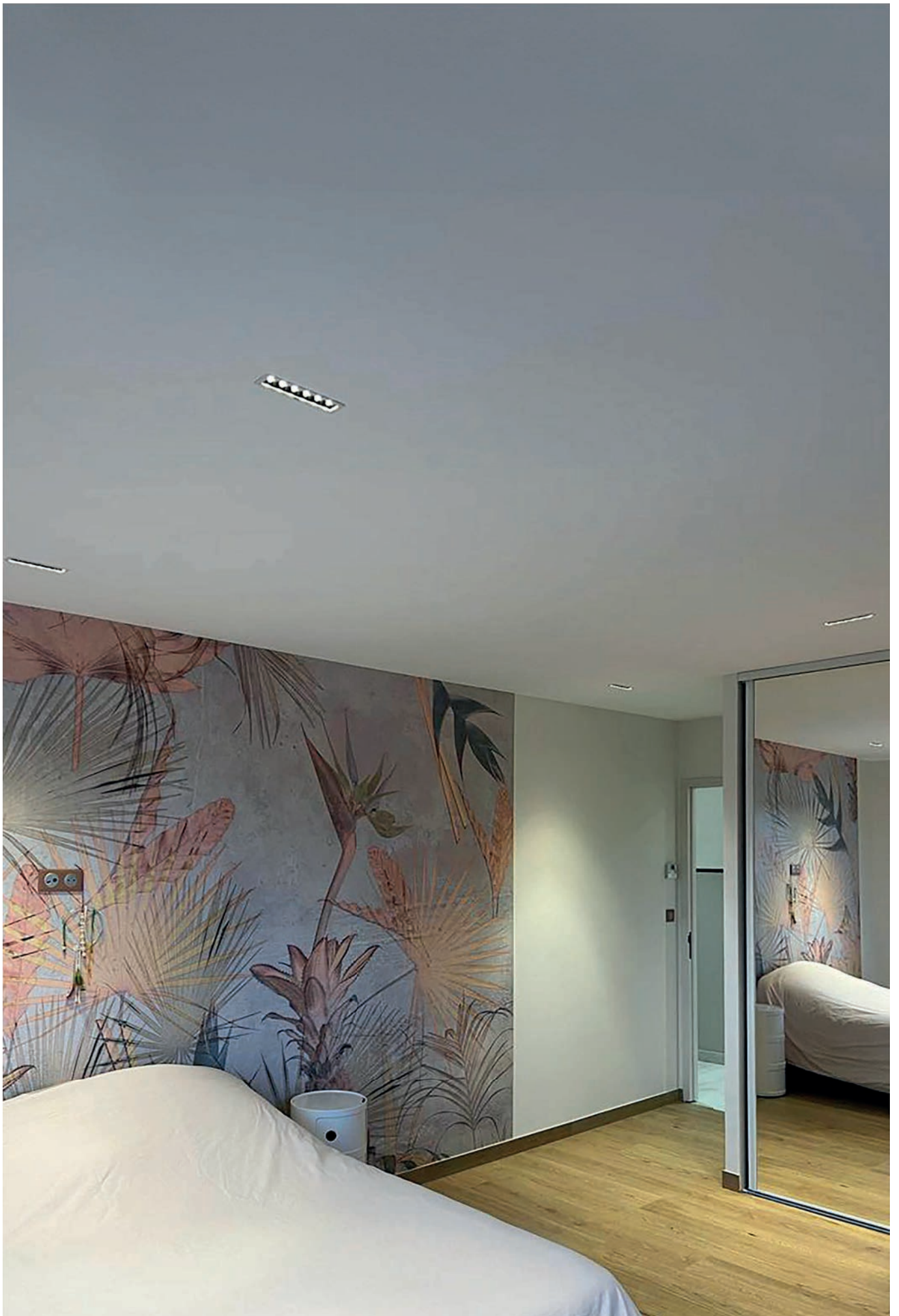

# GARI

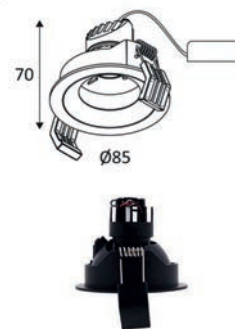
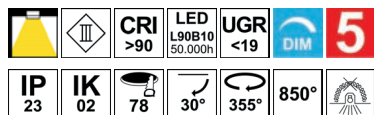

- Spot encastré rond orientable.
- Réflecteur basse luminance.
- Fixation par ressorts.
- Convertisseur dimmable déporté fourni (versions DALI : convertisseur avec fonction push-dim).

GARI	MATIÈRE	LED	T°	LED Lumen	System Lumen	α	€
<b>DIMMABLE COUPURE DE PHASE</b>							
DO378SW05	NOIR MAT	FONTE D'ALUMINIUM	7W	2700K	680 Lm	408 Lm	24° 96,80 B
DO378SW30	BLANC MAT	FONTE D'ALUMINIUM	7W	2700K	680 Lm	408 Lm	24° 96,80 B
DO378WW05	NOIR MAT	FONTE D'ALUMINIUM	7W	3000K	700 Lm	420 Lm	24° 96,80 B
DO378WW30	BLANC MAT	FONTE D'ALUMINIUM	7W	3000K	700 Lm	420 Lm	24° 96,80 B
DO378NW05	NOIR MAT	FONTE D'ALUMINIUM	7W	4000K	720 Lm	469 Lm	24° 96,80 B
DO378NW30	BLANC MAT	FONTE D'ALUMINIUM	7W	4000K	720 Lm	469 Lm	24° 96,80 B
DO377SW05	NOIR MAT	FONTE D'ALUMINIUM	7W	2700K	680 Lm	423 Lm	36° 96,80 B
DO377SW30	BLANC MAT	FONTE D'ALUMINIUM	7W	2700K	680 Lm	423 Lm	36° 96,80 B
DO377WW05	NOIR MAT	FONTE D'ALUMINIUM	7W	3000K	700 Lm	449 Lm	36° 96,80 B
DO377WW30	BLANC MAT	FONTE D'ALUMINIUM	7W	3000K	700 Lm	449 Lm	36° 96,80 B
DO377NW05	NOIR MAT	FONTE D'ALUMINIUM	7W	4000K	720 Lm	519 Lm	36° 96,80 B
DO377NW30	BLANC MAT	FONTE D'ALUMINIUM	7W	4000K	720 Lm	519 Lm	36° 96,80 B
<b>DIMMABLE DALI</b>							
DO378SW05DA	NOIR MAT	FONTE D'ALUMINIUM	7W	2700K	680 Lm	408 Lm	24° 147,30 B
DO378SW30DA	BLANC MAT	FONTE D'ALUMINIUM	7W	2700K	680 Lm	408 Lm	24° 147,30 B
DO378WW05DA	NOIR MAT	FONTE D'ALUMINIUM	7W	3000K	700 Lm	420 Lm	24° 147,30 B
DO378WW30DA	BLANC MAT	FONTE D'ALUMINIUM	7W	3000K	700 Lm	420 Lm	24° 147,30 B
DO378NW05DA	NOIR MAT	FONTE D'ALUMINIUM	7W	4000K	720 Lm	469 Lm	24° 147,30 B
DO378NW30DA	BLANC MAT	FONTE D'ALUMINIUM	7W	4000K	720 Lm	469 Lm	24° 147,30 B
DO377SW05DA	NOIR MAT	FONTE D'ALUMINIUM	7W	2700K	680 Lm	423 Lm	36° 147,30 B
DO377SW30DA	BLANC MAT	FONTE D'ALUMINIUM	7W	2700K	680 Lm	423 Lm	36° 147,30 B
DO377WW05DA	NOIR MAT	FONTE D'ALUMINIUM	7W	3000K	700 Lm	449 Lm	36° 147,30 B
DO377WW30DA	BLANC MAT	FONTE D'ALUMINIUM	7W	3000K	700 Lm	449 Lm	36° 147,30 B
DO377NW05DA	NOIR MAT	FONTE D'ALUMINIUM	7W	4000K	720 Lm	519 Lm	36° 147,30 B
DO377NW30DA	BLANC MAT	FONTE D'ALUMINIUM	7W	4000K	720 Lm	519 Lm	36° 147,30 B





## GARI POWER

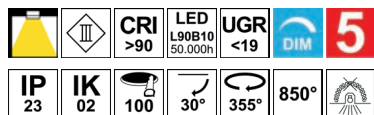

- Spot encastré rond orientable.
- Réflecteur basse luminance.
- Fixation par ressorts.
- Convertisseur dimmable déporté fourni (versions DALI : convertisseur avec fonction push-dim).

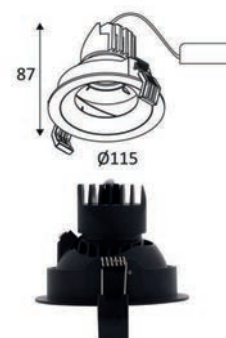

GARI POWER	MATIÈRE	LED	T°	LED Lumen	System Lumen	α	€
<b>DIMMABLE COUPURE DE PHASE</b>							
DO391SW05	NOIR MAT	FONTE D'ALUMINIUM	13W	2700K	1260 Lm	878 Lm	15° 125,70 B
DO391SW30	BLANC MAT	FONTE D'ALUMINIUM	13W	2700K	1260 Lm	878 Lm	15° 125,70 B
DO391WW05	NOIR MAT	FONTE D'ALUMINIUM	13W	3000K	1300 Lm	972 Lm	15° 125,70 B
DO391WW30	BLANC MAT	FONTE D'ALUMINIUM	13W	3000K	1300 Lm	972 Lm	15° 125,70 B
DO391NW05	NOIR MAT	FONTE D'ALUMINIUM	13W	4000K	1340 Lm	1042 Lm	15° 125,70 B
DO391NW30	BLANC MAT	FONTE D'ALUMINIUM	13W	4000K	1340 Lm	1042 Lm	15° 125,70 B
DO390SW05	NOIR MAT	FONTE D'ALUMINIUM	13W	2700K	1260 Lm	897 Lm	30° 125,70 B
DO390SW30	BLANC MAT	FONTE D'ALUMINIUM	13W	2700K	1260 Lm	897 Lm	30° 125,70 B
DO390WW05	NOIR MAT	FONTE D'ALUMINIUM	13W	3000K	1300 Lm	944 Lm	30° 125,70 B
DO390WW30	BLANC MAT	FONTE D'ALUMINIUM	13W	3000K	1300 Lm	944 Lm	30° 125,70 B
DO390NW05	NOIR MAT	FONTE D'ALUMINIUM	13W	4000K	1340 Lm	970 Lm	30° 125,70 B
DO390NW30	BLANC MAT	FONTE D'ALUMINIUM	13W	4000K	1340 Lm	970 Lm	30° 125,70 B
DO389SW05	NOIR MAT	FONTE D'ALUMINIUM	13W	2700K	1260 Lm	816 Lm	50° 125,70 B
DO389SW30	BLANC MAT	FONTE D'ALUMINIUM	13W	2700K	1260 Lm	816 Lm	50° 125,70 B
DO389WW05	NOIR MAT	FONTE D'ALUMINIUM	13W	3000K	1300 Lm	913 Lm	50° 125,70 B
DO389WW30	BLANC MAT	FONTE D'ALUMINIUM	13W	3000K	1300 Lm	913 Lm	50° 125,70 B
DO389NW05	NOIR MAT	FONTE D'ALUMINIUM	13W	4000K	1340 Lm	1169 Lm	50° 125,70 B
DO389NW30	BLANC MAT	FONTE D'ALUMINIUM	13W	4000K	1340 Lm	1169 Lm	50° 125,70 B
<b>DIMMABLE DALI</b>							
DO391SW05DA	NOIR MAT	FONTE D'ALUMINIUM	13W	2700K	1260 Lm	878 Lm	15° 189,50 B
DO391SW30DA	BLANC MAT	FONTE D'ALUMINIUM	13W	2700K	1260 Lm	878 Lm	15° 189,50 B
DO391WW05DA	NOIR MAT	FONTE D'ALUMINIUM	13W	3000K	1300 Lm	972 Lm	15° 189,50 B
DO391WW30DA	BLANC MAT	FONTE D'ALUMINIUM	13W	3000K	1300 Lm	972 Lm	15° 189,50 B
DO391NW05DA	NOIR MAT	FONTE D'ALUMINIUM	13W	4000K	1340 Lm	1042 Lm	15° 189,50 B
DO391NW30DA	BLANC MAT	FONTE D'ALUMINIUM	13W	4000K	1340 Lm	1042 Lm	15° 189,50 B
DO390SW05DA	NOIR MAT	FONTE D'ALUMINIUM	13W	2700K	1260 Lm	897 Lm	30° 189,50 B
DO390SW30DA	BLANC MAT	FONTE D'ALUMINIUM	13W	2700K	1260 Lm	897 Lm	30° 189,50 B
DO390WW05DA	NOIR MAT	FONTE D'ALUMINIUM	13W	3000K	1300 Lm	944 Lm	30° 189,50 B
DO390WW30DA	BLANC MAT	FONTE D'ALUMINIUM	13W	3000K	1300 Lm	944 Lm	30° 189,50 B
DO390NW05DA	NOIR MAT	FONTE D'ALUMINIUM	13W	4000K	1340 Lm	970 Lm	30° 189,50 B
DO390NW30DA	BLANC MAT	FONTE D'ALUMINIUM	13W	4000K	1340 Lm	970 Lm	30° 189,50 B
DO389SW05DA	NOIR MAT	FONTE D'ALUMINIUM	13W	2700K	1260 Lm	816 Lm	50° 189,50 B
DO389SW30DA	BLANC MAT	FONTE D'ALUMINIUM	13W	2700K	1260 Lm	816 Lm	50° 189,50 B
DO389WW05DA	NOIR MAT	FONTE D'ALUMINIUM	13W	3000K	1300 Lm	913 Lm	50° 189,50 B
DO389WW30DA	BLANC MAT	FONTE D'ALUMINIUM	13W	3000K	1300 Lm	913 Lm	50° 189,50 B
DO389NW05DA	NOIR MAT	FONTE D'ALUMINIUM	13W	4000K	1340 Lm	1169 Lm	50° 189,50 B
DO389NW30DA	BLANC MAT	FONTE D'ALUMINIUM	13W	4000K	1340 Lm	1169 Lm	50° 189,50 B



NOIR MAT



BLANC MAT

## DUCA

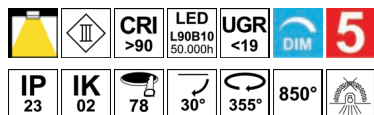

- Spot encastré rond orientable.
- Réflecteur basse luminance.
- Anneau réducteur de faisceau.
- Fixation par ressorts.
- Convertisseur dimmable déporté fourni (versions DALI : convertisseur avec fonction push-dim).

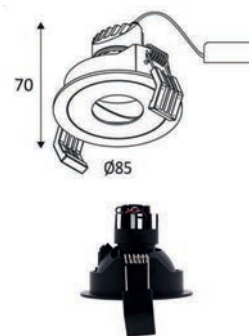

DUCA	MATIÈRE	LED	T°	LED Lumen	System Lumen	α	€
<b>DIMMABLE COUPURE DE PHASE</b>							
DO380SW05	NOIR MAT	FONTE D'ALUMINIUM	7W	2700K	680 Lm	370 Lm	24° 103,00 B
DO380SW30	BLANC MAT	FONTE D'ALUMINIUM	7W	2700K	680 Lm	370 Lm	24° 103,00 B
DO380WW05	NOIR MAT	FONTE D'ALUMINIUM	7W	3000K	700 Lm	391 Lm	24° 103,00 B
DO380WW30	BLANC MAT	FONTE D'ALUMINIUM	7W	3000K	700 Lm	391 Lm	24° 103,00 B
DO380NW05	NOIR MAT	FONTE D'ALUMINIUM	7W	4000K	720 Lm	487 Lm	24° 103,00 B
DO380NW30	BLANC MAT	FONTE D'ALUMINIUM	7W	4000K	720 Lm	487 Lm	24° 103,00 B
<b>DIMMABLE DALI</b>							
DO380SW05DA	NOIR MAT	FONTE D'ALUMINIUM	7W	2700K	680 Lm	370 Lm	24° 154,50 B
DO380SW30DA	BLANC MAT	FONTE D'ALUMINIUM	7W	2700K	680 Lm	370 Lm	24° 154,50 B
DO380WW05DA	NOIR MAT	FONTE D'ALUMINIUM	7W	3000K	700 Lm	391 Lm	24° 154,50 B
DO380WW30DA	BLANC MAT	FONTE D'ALUMINIUM	7W	3000K	700 Lm	391 Lm	24° 154,50 B
DO380NW05DA	NOIR MAT	FONTE D'ALUMINIUM	7W	4000K	720 Lm	487 Lm	24° 154,50 B
DO380NW30DA	BLANC MAT	FONTE D'ALUMINIUM	7W	4000K	720 Lm	487 Lm	24° 154,50 B
DO379SW05DA	NOIR MAT	FONTE D'ALUMINIUM	7W	2700K	680 Lm	354 Lm	36° 154,50 B
DO379SW30DA	BLANC MAT	FONTE D'ALUMINIUM	7W	2700K	680 Lm	354 Lm	36° 154,50 B
DO379WW05DA	NOIR MAT	FONTE D'ALUMINIUM	7W	3000K	700 Lm	393 Lm	36° 154,50 B
DO379WW30DA	BLANC MAT	FONTE D'ALUMINIUM	7W	3000K	700 Lm	393 Lm	36° 154,50 B
DO379NW05DA	NOIR MAT	FONTE D'ALUMINIUM	7W	4000K	720 Lm	468 Lm	36° 154,50 B
DO379NW30DA	BLANC MAT	FONTE D'ALUMINIUM	7W	4000K	720 Lm	468 Lm	36° 154,50 B







## DUCA POWER

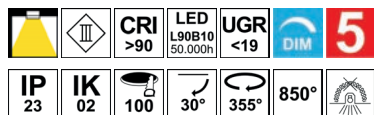

- Spot encastré rond orientable.
- Réflecteur basse luminance.
- Anneau réducteur de faisceau.
- Fixation par ressorts.
- Convertisseur dimmable déporté fourni (versions DALI : convertisseur avec fonction push-dim).

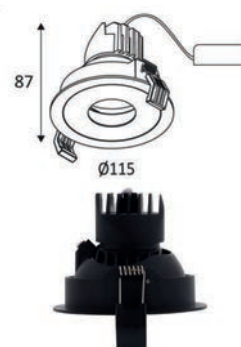

DUCA POWER	MATIÈRE	LED	T°	LED Lumen	System Lumen	α	€	
<b>DIMMABLE COUPURE DE PHASE</b>								
DO394SW05	NOIR MAT	FONTE D'ALUMINIUM	13W	2700K	1260 Lm	632 Lm	15°	138,00 B
DO394SW30	BLANC MAT	FONTE D'ALUMINIUM	13W	2700K	1260 Lm	632 Lm	15°	138,00 B
DO394WW05	NOIR MAT	FONTE D'ALUMINIUM	13W	3000K	1300 Lm	752 Lm	15°	138,00 B
DO394WW30	BLANC MAT	FONTE D'ALUMINIUM	13W	3000K	1300 Lm	752 Lm	15°	138,00 B
DO394NW05	NOIR MAT	FONTE D'ALUMINIUM	13W	4000K	1340 Lm	768 Lm	15°	138,00 B
DO394NW30	BLANC MAT	FONTE D'ALUMINIUM	13W	4000K	1340 Lm	768 Lm	15°	138,00 B
DO393SW05	NOIR MAT	FONTE D'ALUMINIUM	13W	2700K	1260 Lm	534 Lm	30°	138,00 B
DO393SW30	BLANC MAT	FONTE D'ALUMINIUM	13W	2700K	1260 Lm	534 Lm	30°	138,00 B
DO393WW05	NOIR MAT	FONTE D'ALUMINIUM	13W	3000K	1300 Lm	646 Lm	30°	138,00 B
DO393WW30	BLANC MAT	FONTE D'ALUMINIUM	13W	3000K	1300 Lm	646 Lm	30°	138,00 B
DO393NW05	NOIR MAT	FONTE D'ALUMINIUM	13W	4000K	1340 Lm	657 Lm	30°	138,00 B
DO393NW30	BLANC MAT	FONTE D'ALUMINIUM	13W	4000K	1340 Lm	657 Lm	30°	138,00 B
DO392SW05	NOIR MAT	FONTE D'ALUMINIUM	13W	2700K	1260 Lm	706 Lm	50°	138,00 B
DO392SW30	BLANC MAT	FONTE D'ALUMINIUM	13W	2700K	1260 Lm	706 Lm	50°	138,00 B
DO392WW05	NOIR MAT	FONTE D'ALUMINIUM	13W	3000K	1300 Lm	868 Lm	50°	138,00 B
DO392WW30	BLANC MAT	FONTE D'ALUMINIUM	13W	3000K	1300 Lm	868 Lm	50°	138,00 B
DO392NW05	NOIR MAT	FONTE D'ALUMINIUM	13W	4000K	1340 Lm	890 Lm	50°	138,00 B
DO392NW30	BLANC MAT	FONTE D'ALUMINIUM	13W	4000K	1340 Lm	890 Lm	50°	138,00 B
<b>DIMMABLE DALI</b>								
DO394SW05DA	NOIR MAT	FONTE D'ALUMINIUM	13W	2700K	1260 Lm	632 Lm	15°	200,90 B
DO394SW30DA	BLANC MAT	FONTE D'ALUMINIUM	13W	2700K	1260 Lm	632 Lm	15°	200,90 B
DO394WW05DA	NOIR MAT	FONTE D'ALUMINIUM	13W	3000K	1300 Lm	752 Lm	15°	200,90 B
DO394WW30DA	BLANC MAT	FONTE D'ALUMINIUM	13W	3000K	1300 Lm	752 Lm	15°	200,90 B
DO394NW05DA	NOIR MAT	FONTE D'ALUMINIUM	13W	4000K	1340 Lm	768 Lm	15°	200,90 B
DO394NW30DA	BLANC MAT	FONTE D'ALUMINIUM	13W	4000K	1340 Lm	768 Lm	15°	200,90 B
DO393SW05DA	NOIR MAT	FONTE D'ALUMINIUM	13W	2700K	1260 Lm	534 Lm	30°	200,90 B
DO393SW30DA	BLANC MAT	FONTE D'ALUMINIUM	13W	2700K	1260 Lm	534 Lm	30°	200,90 B
DO393WW05DA	NOIR MAT	FONTE D'ALUMINIUM	13W	3000K	1300 Lm	646 Lm	30°	200,90 B
DO393WW30DA	BLANC MAT	FONTE D'ALUMINIUM	13W	3000K	1300 Lm	646 Lm	30°	200,90 B
DO393NW05DA	NOIR MAT	FONTE D'ALUMINIUM	13W	4000K	1340 Lm	657 Lm	30°	200,90 B
DO393NW30DA	BLANC MAT	FONTE D'ALUMINIUM	13W	4000K	1340 Lm	657 Lm	30°	200,90 B
DO392SW05DA	NOIR MAT	FONTE D'ALUMINIUM	13W	2700K	1260 Lm	706 Lm	50°	200,90 B
DO392SW30DA	BLANC MAT	FONTE D'ALUMINIUM	13W	2700K	1260 Lm	706 Lm	50°	200,90 B
DO392WW05DA	NOIR MAT	FONTE D'ALUMINIUM	13W	3000K	1300 Lm	868 Lm	50°	200,90 B
DO392WW30DA	BLANC MAT	FONTE D'ALUMINIUM	13W	3000K	1300 Lm	868 Lm	50°	200,90 B
DO392NW05DA	NOIR MAT	FONTE D'ALUMINIUM	13W	4000K	1340 Lm	890 Lm	50°	200,90 B
DO392NW30DA	BLANC MAT	FONTE D'ALUMINIUM	13W	4000K	1340 Lm	890 Lm	50°	200,90 B



NOIR MAT



BLANC MAT

# LENA

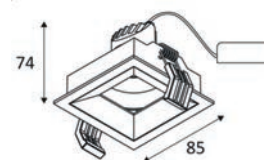
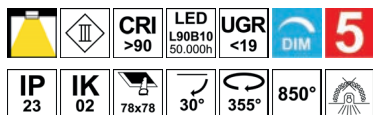

- Spot encastré carré orientable.
- Réflecteur basse luminance.
- Fixation par ressorts.
- Convertisseur dimmable déporté fourni (versions DALI : convertisseur avec fonction push-dim).



LENA	MATIÈRE	LED	T°	LED Lumen	System Lumen	α	€	
<b>DIMMABLE COUPURE DE PHASE</b>								
DO386SW05	NOIR MAT	FONTE D'ALUMINIUM	7W	2700K	680 Lm	386 Lm	24°	100,90 B
DO386SW30	BLANC MAT	FONTE D'ALUMINIUM	7W	2700K	680 Lm	386 Lm	24°	100,90 B
DO386WW05	NOIR MAT	FONTE D'ALUMINIUM	7W	3000K	700 Lm	414 Lm	24°	100,90 B
DO386WW30	BLANC MAT	FONTE D'ALUMINIUM	7W	3000K	700 Lm	414 Lm	24°	100,90 B
DO386NW05	NOIR MAT	FONTE D'ALUMINIUM	7W	4000K	720 Lm	447 Lm	24°	100,90 B
DO386NW30	BLANC MAT	FONTE D'ALUMINIUM	7W	4000K	720 Lm	447 Lm	24°	100,90 B
DO385SW05	NOIR MAT	FONTE D'ALUMINIUM	7W	2700K	680 Lm	372 Lm	36°	100,90 B
DO385SW30	BLANC MAT	FONTE D'ALUMINIUM	7W	2700K	680 Lm	372 Lm	36°	100,90 B
DO385WW05	NOIR MAT	FONTE D'ALUMINIUM	7W	3000K	700 Lm	417 Lm	36°	100,90 B
DO385WW30	BLANC MAT	FONTE D'ALUMINIUM	7W	3000K	700 Lm	417 Lm	36°	100,90 B
DO385NW05	NOIR MAT	FONTE D'ALUMINIUM	7W	4000K	720 Lm	495 Lm	36°	100,90 B
DO385NW30	BLANC MAT	FONTE D'ALUMINIUM	7W	4000K	720 Lm	495 Lm	36°	100,90 B
<b>DIMMABLE DALI</b>								
DO386SW05DA	NOIR MAT	FONTE D'ALUMINIUM	7W	2700K	680 Lm	386 Lm	24°	153,50 B
DO386SW30DA	BLANC MAT	FONTE D'ALUMINIUM	7W	2700K	680 Lm	386 Lm	24°	153,50 B
DO386WW05DA	NOIR MAT	FONTE D'ALUMINIUM	7W	3000K	700 Lm	414 Lm	24°	153,50 B
DO386WW30DA	BLANC MAT	FONTE D'ALUMINIUM	7W	3000K	700 Lm	414 Lm	24°	153,50 B
DO386NW05DA	NOIR MAT	FONTE D'ALUMINIUM	7W	4000K	720 Lm	447 Lm	24°	153,50 B
DO386NW30DA	BLANC MAT	FONTE D'ALUMINIUM	7W	4000K	720 Lm	447 Lm	24°	153,50 B
DO385SW05DA	NOIR MAT	FONTE D'ALUMINIUM	7W	2700K	680 Lm	372 Lm	36°	153,50 B
DO385SW30DA	BLANC MAT	FONTE D'ALUMINIUM	7W	2700K	680 Lm	372 Lm	36°	153,50 B
DO385WW05DA	NOIR MAT	FONTE D'ALUMINIUM	7W	3000K	700 Lm	417 Lm	36°	153,50 B
DO385WW30DA	BLANC MAT	FONTE D'ALUMINIUM	7W	3000K	700 Lm	417 Lm	36°	153,50 B
DO385NW05DA	NOIR MAT	FONTE D'ALUMINIUM	7W	4000K	720 Lm	495 Lm	36°	153,50 B
DO385NW30DA	BLANC MAT	FONTE D'ALUMINIUM	7W	4000K	720 Lm	495 Lm	36°	153,50 B

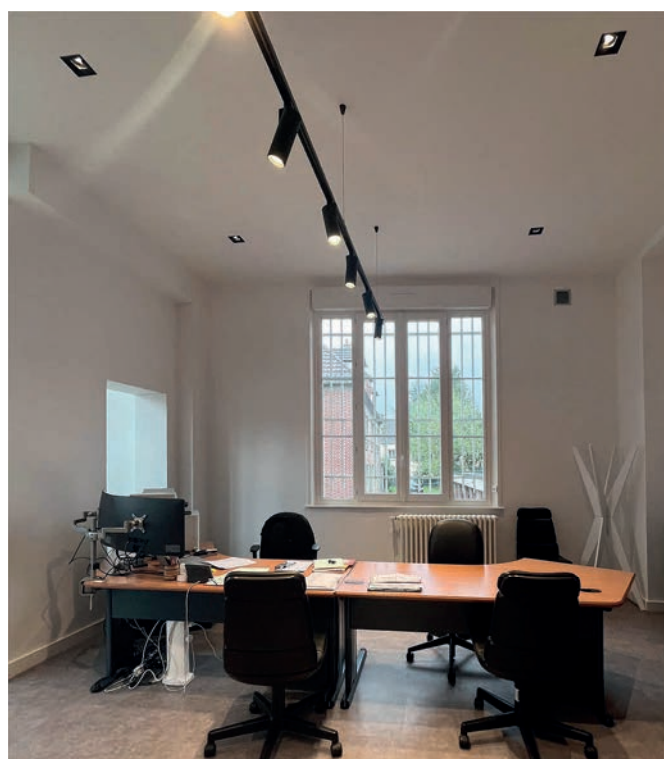



## LENA POWER

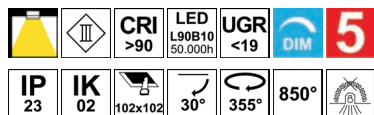

- Spot encastré carré orientable.
- Réflecteur basse luminance.
- Fixation par ressorts.
- Convertisseur dimmable déporté fourni (versions DALI : convertisseur avec fonction push-dim).

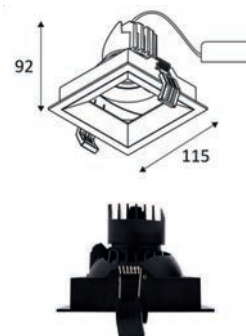

LENA POWER	MATIÈRE	LED	T°	LED Lumen	System Lumen	α	€
<b>DIMMABLE COUPURE DE PHASE</b>							
DO401SW05	NOIR MAT	FONTE D'ALUMINIUM	13W	2700K	1260 Lm	784 Lm	15° 131,80 B
DO401SW30	BLANC MAT	FONTE D'ALUMINIUM	13W	2700K	1260 Lm	784 Lm	15° 131,80 B
DO401WW05	NOIR MAT	FONTE D'ALUMINIUM	13W	3000K	1300 Lm	941 Lm	15° 131,80 B
DO401WW30	BLANC MAT	FONTE D'ALUMINIUM	13W	3000K	1300 Lm	941 Lm	15° 131,80 B
DO401NW05	NOIR MAT	FONTE D'ALUMINIUM	13W	4000K	1340 Lm	993 Lm	15° 131,80 B
DO401NW30	BLANC MAT	FONTE D'ALUMINIUM	13W	4000K	1340 Lm	993 Lm	15° 131,80 B
DO402SW05	NOIR MAT	FONTE D'ALUMINIUM	13W	2700K	1260 Lm	688 Lm	30° 131,80 B
DO402SW30	BLANC MAT	FONTE D'ALUMINIUM	13W	2700K	1260 Lm	688 Lm	30° 131,80 B
DO402WW05	NOIR MAT	FONTE D'ALUMINIUM	13W	3000K	1300 Lm	862 Lm	30° 131,80 B
DO402WW30	BLANC MAT	FONTE D'ALUMINIUM	13W	3000K	1300 Lm	862 Lm	30° 131,80 B
DO402NW05	NOIR MAT	FONTE D'ALUMINIUM	13W	4000K	1340 Lm	887 Lm	30° 131,80 B
DO402NW30	BLANC MAT	FONTE D'ALUMINIUM	13W	4000K	1340 Lm	887 Lm	30° 131,80 B
DO403SW05	NOIR MAT	FONTE D'ALUMINIUM	13W	2700K	1260 Lm	807 Lm	50° 131,80 B
DO403SW30	BLANC MAT	FONTE D'ALUMINIUM	13W	2700K	1260 Lm	807 Lm	50° 131,80 B
DO403WW05	NOIR MAT	FONTE D'ALUMINIUM	13W	3000K	1300 Lm	996 Lm	50° 131,80 B
DO403WW30	BLANC MAT	FONTE D'ALUMINIUM	13W	3000K	1300 Lm	996 Lm	50° 131,80 B
DO403NW05	NOIR MAT	FONTE D'ALUMINIUM	13W	4000K	1340 Lm	1010 Lm	50° 131,80 B
DO403NW30	BLANC MAT	FONTE D'ALUMINIUM	13W	4000K	1340 Lm	1010 Lm	50° 131,80 B
<b>DIMMABLE DALI</b>							
DO401SW05DA	NOIR MAT	FONTE D'ALUMINIUM	13W	2700K	1260 Lm	784 Lm	15° 195,70 B
DO401SW30DA	BLANC MAT	FONTE D'ALUMINIUM	13W	2700K	1260 Lm	784 Lm	15° 195,70 B
DO401WW05DA	NOIR MAT	FONTE D'ALUMINIUM	13W	3000K	1300 Lm	941 Lm	15° 195,70 B
DO401WW30DA	BLANC MAT	FONTE D'ALUMINIUM	13W	3000K	1300 Lm	941 Lm	15° 195,70 B
DO401NW05DA	NOIR MAT	FONTE D'ALUMINIUM	13W	4000K	1340 Lm	993 Lm	15° 195,70 B
DO401NW30DA	BLANC MAT	FONTE D'ALUMINIUM	13W	4000K	1340 Lm	993 Lm	15° 195,70 B
DO402SW05DA	NOIR MAT	FONTE D'ALUMINIUM	13W	2700K	1260 Lm	688 Lm	30° 195,70 B
DO402SW30DA	BLANC MAT	FONTE D'ALUMINIUM	13W	2700K	1260 Lm	688 Lm	30° 195,70 B
DO402WW05DA	NOIR MAT	FONTE D'ALUMINIUM	13W	3000K	1300 Lm	862 Lm	30° 195,70 B
DO402WW30DA	BLANC MAT	FONTE D'ALUMINIUM	13W	3000K	1300 Lm	862 Lm	30° 195,70 B
DO402NW05DA	NOIR MAT	FONTE D'ALUMINIUM	13W	4000K	1340 Lm	887 Lm	30° 195,70 B
DO402NW30DA	BLANC MAT	FONTE D'ALUMINIUM	13W	4000K	1340 Lm	887 Lm	30° 195,70 B
DO403SW05DA	NOIR MAT	FONTE D'ALUMINIUM	13W	2700K	1260 Lm	807 Lm	50° 195,70 B
DO403SW30DA	BLANC MAT	FONTE D'ALUMINIUM	13W	2700K	1260 Lm	807 Lm	50° 195,70 B
DO403WW05DA	NOIR MAT	FONTE D'ALUMINIUM	13W	3000K	1300 Lm	996 Lm	50° 195,70 B
DO403WW30DA	BLANC MAT	FONTE D'ALUMINIUM	13W	3000K	1300 Lm	996 Lm	50° 195,70 B
DO403NW05DA	NOIR MAT	FONTE D'ALUMINIUM	13W	4000K	1340 Lm	1010 Lm	50° 195,70 B
DO403NW30DA	BLANC MAT	FONTE D'ALUMINIUM	13W	4000K	1340 Lm	1010 Lm	50° 195,70 B



NOIR MAT



BLANC MAT

## SORA POWER

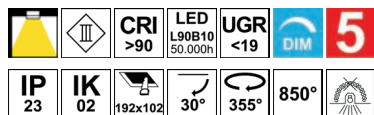

- Spot encastré rectangulaire orientable.
- Réflecteur basse luminance.
- Fixation par ressorts.
- Convertisseurs dimmables déportés fournis (versions DALI : convertisseurs avec fonction push-dim).

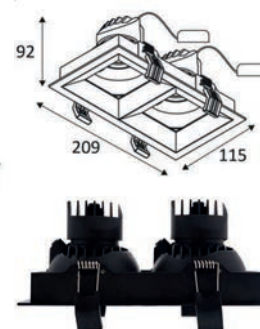

SORA POWER	MATIÈRE	LED	T°	LED Lumen	System Lumen	α	€
<b>DIMMABLE COUPURE DE PHASE</b>							
DO409SW05	NOIR MAT	FONTE D'ALUMINIUM	2x13W	2700K	2x1260 Lm	2x784 Lm	15° 216,30 B
DO409SW30	BLANC MAT	FONTE D'ALUMINIUM	2x13W	2700K	2x1260 Lm	2x784 Lm	15° 216,30 B
DO409WW05	NOIR MAT	FONTE D'ALUMINIUM	2x13W	3000K	2x1300 Lm	2x941 Lm	15° 216,30 B
DO409WW30	BLANC MAT	FONTE D'ALUMINIUM	2x13W	3000K	2x1300 Lm	2x941 Lm	15° 216,30 B
DO409NW05	NOIR MAT	FONTE D'ALUMINIUM	2x13W	4000K	2x1340 Lm	2x993 Lm	15° 216,30 B
DO409NW30	BLANC MAT	FONTE D'ALUMINIUM	2x13W	4000K	2x1340 Lm	2x993 Lm	15° 216,30 B
DO408SW05	NOIR MAT	FONTE D'ALUMINIUM	2x13W	2700K	2x1260 Lm	2x688 Lm	30° 216,30 B
DO408SW30	BLANC MAT	FONTE D'ALUMINIUM	2x13W	2700K	2x1260 Lm	2x688 Lm	30° 216,30 B
DO408WW05	NOIR MAT	FONTE D'ALUMINIUM	2x13W	3000K	2x1300 Lm	2x862 Lm	30° 216,30 B
DO408WW30	BLANC MAT	FONTE D'ALUMINIUM	2x13W	3000K	2x1300 Lm	2x862 Lm	30° 216,30 B
DO408NW05	NOIR MAT	FONTE D'ALUMINIUM	2x13W	4000K	2x1340 Lm	2x887 Lm	30° 216,30 B
DO408NW30	BLANC MAT	FONTE D'ALUMINIUM	2x13W	4000K	2x1340 Lm	2x887 Lm	30° 216,30 B
DO407SW05	NOIR MAT	FONTE D'ALUMINIUM	2x13W	2700K	2x1260 Lm	2x807 Lm	50° 216,30 B
DO407SW30	BLANC MAT	FONTE D'ALUMINIUM	2x13W	2700K	2x1260 Lm	2x807 Lm	50° 216,30 B
DO407WW05	NOIR MAT	FONTE D'ALUMINIUM	2x13W	3000K	2x1300 Lm	2x996 Lm	50° 216,30 B
DO407WW30	BLANC MAT	FONTE D'ALUMINIUM	2x13W	3000K	2x1300 Lm	2x996 Lm	50° 216,30 B
DO407NW05	NOIR MAT	FONTE D'ALUMINIUM	2x13W	4000K	2x1340 Lm	2x1010 Lm	50° 216,30 B
DO407NW30	BLANC MAT	FONTE D'ALUMINIUM	2x13W	4000K	2x1340 Lm	2x1010 Lm	50° 216,30 B
<b>DIMMABLE DALI</b>							
DO409SW05DA	NOIR MAT	FONTE D'ALUMINIUM	2x13W	2700K	2x1260 Lm	2x784 Lm	15° 298,70 B
DO409SW30DA	BLANC MAT	FONTE D'ALUMINIUM	2x13W	2700K	2x1260 Lm	2x784 Lm	15° 298,70 B
DO409WW05DA	NOIR MAT	FONTE D'ALUMINIUM	2x13W	3000K	2x1300 Lm	2x941 Lm	15° 298,70 B
DO409WW30DA	BLANC MAT	FONTE D'ALUMINIUM	2x13W	3000K	2x1300 Lm	2x941 Lm	15° 298,70 B
DO409NW05DA	NOIR MAT	FONTE D'ALUMINIUM	2x13W	4000K	2x1340 Lm	2x993 Lm	15° 298,70 B
DO409NW30DA	BLANC MAT	FONTE D'ALUMINIUM	2x13W	4000K	2x1340 Lm	2x993 Lm	15° 298,70 B
DO408SW05DA	NOIR MAT	FONTE D'ALUMINIUM	2x13W	2700K	2x1260 Lm	2x688 Lm	30° 298,70 B
DO408SW30DA	BLANC MAT	FONTE D'ALUMINIUM	2x13W	2700K	2x1260 Lm	2x688 Lm	30° 298,70 B
DO408WW05DA	NOIR MAT	FONTE D'ALUMINIUM	2x13W	3000K	2x1300 Lm	2x862 Lm	30° 298,70 B
DO408WW30DA	BLANC MAT	FONTE D'ALUMINIUM	2x13W	3000K	2x1300 Lm	2x862 Lm	30° 298,70 B
DO408NW05DA	NOIR MAT	FONTE D'ALUMINIUM	2x13W	4000K	2x1340 Lm	2x887 Lm	30° 298,70 B
DO408NW30DA	BLANC MAT	FONTE D'ALUMINIUM	2x13W	4000K	2x1340 Lm	2x887 Lm	30° 298,70 B
DO407SW05DA	NOIR MAT	FONTE D'ALUMINIUM	2x13W	2700K	2x1260 Lm	2x807 Lm	50° 298,70 B
DO407SW30DA	BLANC MAT	FONTE D'ALUMINIUM	2x13W	2700K	2x1260 Lm	2x807 Lm	50° 298,70 B
DO407WW05DA	NOIR MAT	FONTE D'ALUMINIUM	2x13W	3000K	2x1300 Lm	2x996 Lm	50° 298,70 B
DO407WW30DA	BLANC MAT	FONTE D'ALUMINIUM	2x13W	3000K	2x1300 Lm	2x996 Lm	50° 298,70 B
DO407NW05DA	NOIR MAT	FONTE D'ALUMINIUM	2x13W	4000K	2x1340 Lm	2x1010 Lm	50° 298,70 B
DO407NW30DA	BLANC MAT	FONTE D'ALUMINIUM	2x13W	4000K	2x1340 Lm	2x1010 Lm	50° 298,70 B



NOIR MAT

BLANC MAT

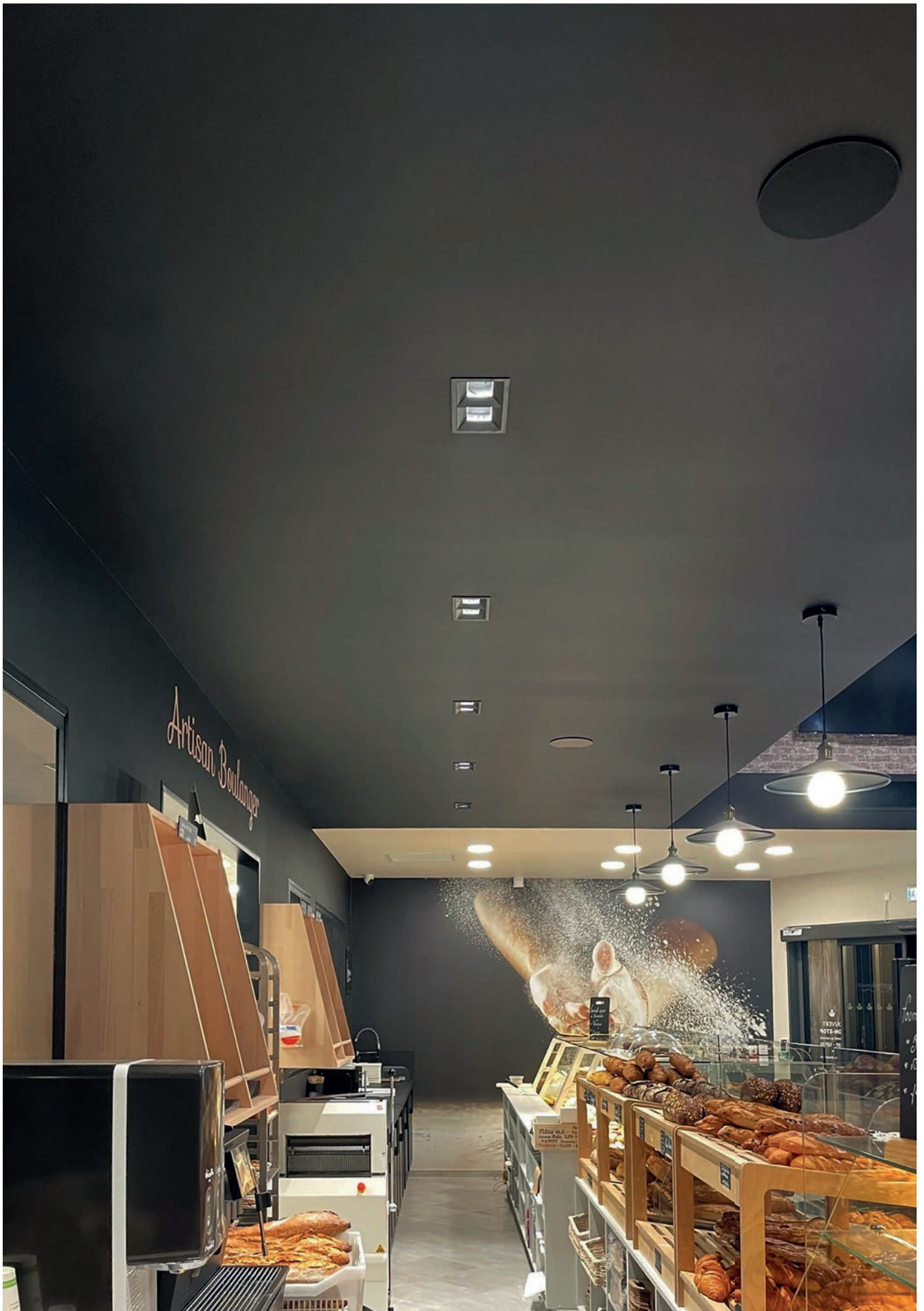

# INDIGO

LIGHTING





**SEMI-ENCASTRÉS**







## AKIS R GU10

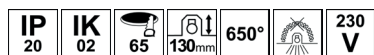

- Spot semi-encastré rond fixe.
- Fixation par ressorts.

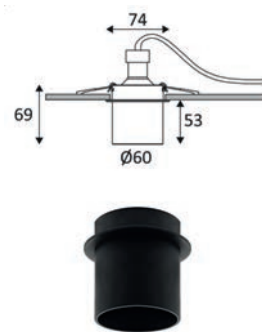

AKIS R GU10		MATIÈRE	SOCKET	LAMP	Watt Max	€
DO51205		NOIR MAT	ALUMINIUM	GU10	PAR16 LED	10W 29,90 B
DO51230		BLANC MAT	ALUMINIUM	GU10	PAR16 LED	10W 29,90 B



NOIR MAT



BLANC MAT

## OKTO RX GU10

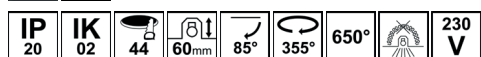

- Spot semi-encastré rond orientable.
- Fixation par ressorts.

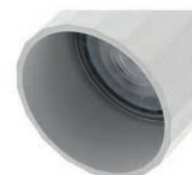
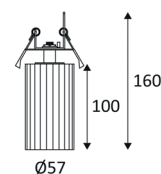

OKTO RX GU10		MATIÈRE	SOCKET	LAMP	Watt Max	€
DO51505		ALUMINIUM	GU10	PAR16 LED	10W	42,20 B
DO51508		ALUMINIUM	GU10	PAR16 LED	10W	46,40 B
DO51506		ALUMINIUM	GU10	PAR16 LED	10W	46,40 B
DO51583		ALUMINIUM	GU10	PAR16 LED	10W	46,40 B
DO51530		ALUMINIUM	GU10	PAR16 LED	10W	42,20 B
DO51549		ALUMINIUM	GU10	PAR16 LED	10W	46,40 B
DO51502		ALUMINIUM	GU10	PAR16 LED	10W	46,40 B
DO51582		ALUMINIUM	GU10	PAR16 LED	10W	46,40 B



NOIR MAT



NOIR MAT -  
CHAMPAGNE



NOIR MAT - OR  
ROSE



NOIR MAT - ROSE



BLANC MAT



BLANC MAT -  
CHAMPAGNE



BLANC MAT - OR  
ROSE



BLANC MAT - ROSE

## FILI 1 RX GU10 AUTO

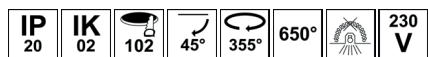

- Spot semi-encastré rond orientable.
- Fixation par ressorts.
- Double bornier automatique.

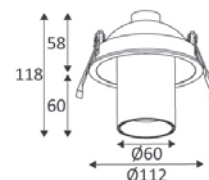

FILI 1 RX GU10 AUTO	MATIÈRE	SOCKET	LAMP	Watt Max	€
DO44405	NOIR MAT ALUMINIUM	GU10 AUTO	PAR16 LED	10W	60,80 B
DO44430	BLANC MAT ALUMINIUM	GU10 AUTO	PAR16 LED	10W	60,80 B

### FILI 1 RX-B

DANS LA MÊME GAMME  
PAGE 108



NOIR MAT

BLANC MAT





## FILI 5 RX-B GU10 AUTO

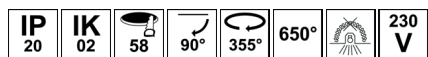

- Spot semi-encastré rond orientable.
- Fixation par lamelles.
- Livré avec réflecteur doré.
- Double bornier automatique.



FILI 5 RX-B GU10 AUTO	MATÉRIE	SOCKET	LAMP	Watt Max	€
DO49105	NOIR MAT	ALUMINIUM	PAR16 LED	10W	70,00 B
DO49130	BLANC MAT	ALUMINIUM	PAR16 LED	10W	70,00 B



NOIR MAT

BLANC MAT



**FILI 5 RDX-B**  
DANS LA MÊME GAMME  
PAGE 109



## CLARA 1 RDX

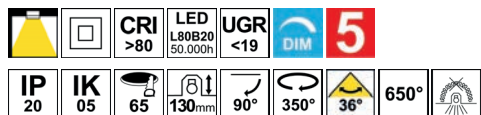

- Spot semi-encastré rond orientable.
- Fixation par ressorts.
- Convertisseur dimmable déporté fourni.
- Compatible avec variateur début et fin de phase.

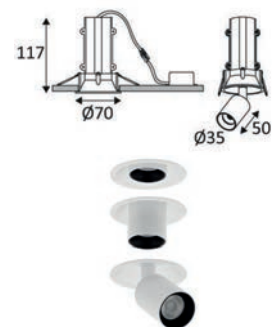

CLARA 1 RDX	MATIÈRE	LED	T°	LED Lumen	System Lumen	€	
DO534WW05	NOIR MAT	ALUMINIUM	3W	3000K	670 Lm	260 Lm	79,30 B
DO534WW30	BLANC MAT	ALUMINIUM	3W	3000K	670 Lm	260 Lm	79,30 B



NOIR MAT



BLANC MAT

## CLARA 2 RDX

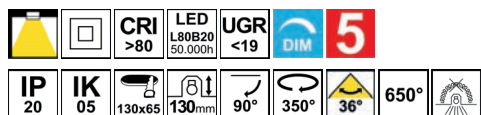

- Spot semi-encastré orientable.
- Fixation par ressorts.
- Convertisseur dimmable déporté fourni.
- Compatible avec variateur début et fin de phase.

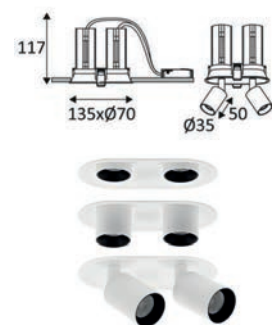

CLARA 2 RDX	MATIÈRE	LED	T°	LED Lumen	System Lumen	€	
DO535WW05	NOIR MAT	ALUMINIUM	2x3W	3000K	2x670 Lm	2x260 Lm	131,80 B
DO535WW30	BLANC MAT	ALUMINIUM	2x3W	3000K	2x670 Lm	2x260 Lm	131,80 B



NOIR MAT



BLANC MAT



## ALLY 1 RX

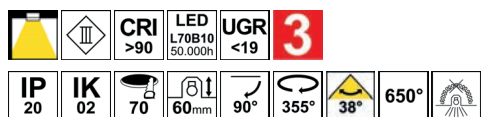

- Spot semi-encastré rond orientable.
- Fixation par ressorts.
- Convertisseur non dimmable déporté fourni.
- En option, convertisseur dimmable DALI-PUSH CD123 à commander séparément.

ALIMENTATION(S)	Watt Max	€
CD123	3-18W	87,60 B

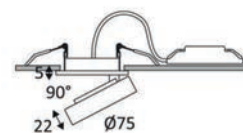

ALLY 1 RX	MATIÈRE	LED	T°	LED Lumen	System Lumen	€	
DO507WW05	NOIR MAT	ALUMINIUM	9W	3000K	675 Lm	490 Lm	104,00 B
DO507WW30	BLANC MAT	ALUMINIUM	9W	3000K	675 Lm	490 Lm	104,00 B



NOIR MAT



BLANC MAT

## ALLY 1 RDX

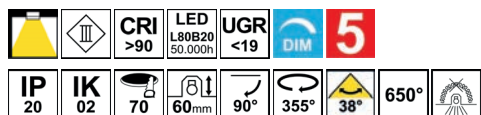

- Spot semi-encastré rond orientable.
- Fixation par ressorts.
- Convertisseur dimmable déporté fourni.
- Compatible avec variateur début et fin de phase.
- En option, convertisseur dimmable DALI-PUSH CD123 à commander séparément.

ALIMENTATION(S)	Watt Max	€
CD123	3-18W	87,60 B

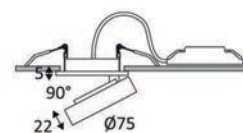

ALLY 1 RDX	MATIÈRE	LED	T°	LED Lumen	System Lumen	€	
DO527WW05	NOIR MAT	ALUMINIUM	10W	3000K	1025 Lm	715 Lm	117,40 B
DO527WW30	BLANC MAT	ALUMINIUM	10W	3000K	1025 Lm	715 Lm	117,40 B



NOIR MAT



BLANC MAT



### ALLY 3 RDX

DANS LA MÊME GAMME  
PAGE 79



## ALLY 2 RX

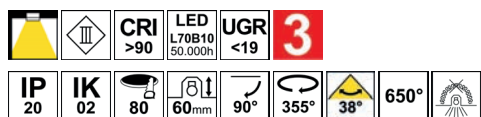

- Spot semi-encastré rond orientable.
- Fixation par ressorts.
- Convertisseur non dimmable déporté fourni.
- En option, convertisseur dimmable DALI-PUSH CD140 à commander séparément.

ALIMENTATION(S)	Watt Max	€
CD140	3-18W	100,90 B

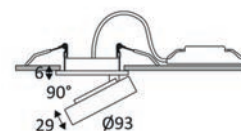

ALLY 2 RX	MATIÈRE	LED	T°	LED Lumen	System Lumen	€	
DO508WW05	NOIR MAT	ALUMINIUM	13W	3000K	1160 Lm	805 Lm	123,60 B
DO508WW30	BLANC MAT	ALUMINIUM	13W	3000K	1160 Lm	805 Lm	123,60 B



NOIR MAT



BLANC MAT

## ALLY 2 RDX

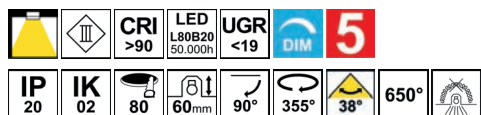

- Spot semi-encastré rond orientable.
- Fixation par ressorts.
- Convertisseur dimmable déporté fourni.
- Compatible avec variateur début et fin de phase.
- En option, convertisseur dimmable DALI-PUSH CD140 à commander séparément.

ALIMENTATION(S)	Watt Max	€
CD140	3-18W	100,90 B

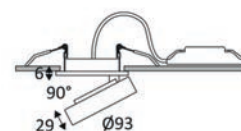

ALLY 2 RDX	MATIÈRE	LED	T°	LED Lumen	System Lumen	€	
DO528WW05	NOIR MAT	ALUMINIUM	14W	3000K	1270 Lm	925 Lm	133,90 B
DO528WW30	BLANC MAT	ALUMINIUM	14W	3000K	1270 Lm	925 Lm	133,90 B



NOIR MAT



BLANC MAT



### ALLY 4 RDX

DANS LA MÊME GAMME  
PAGE 79



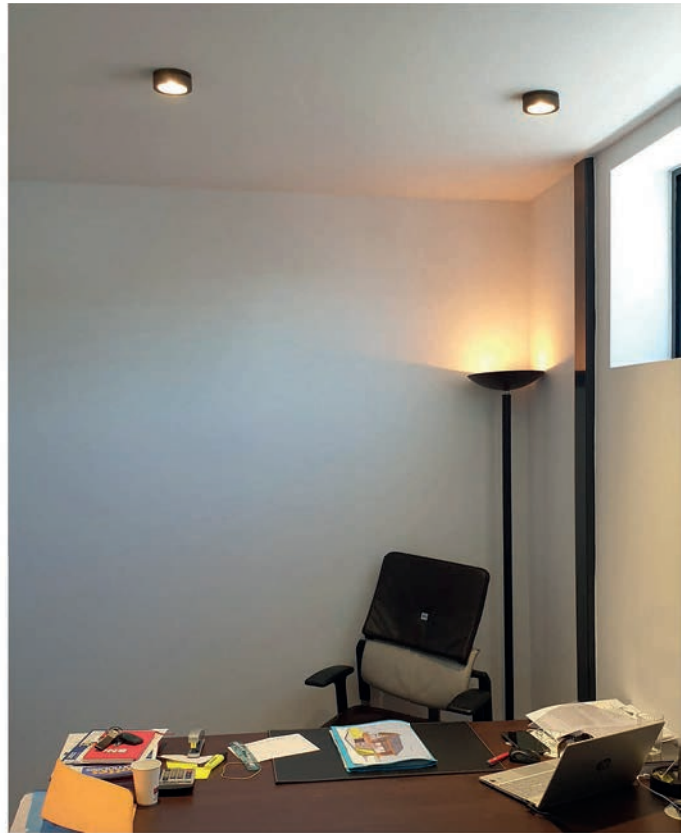

## CLIC RDX MINI

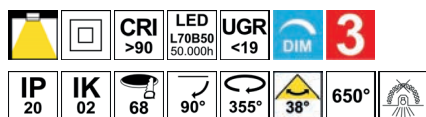

- Spot semi-encastré rond orientable.
- Fixation par ressorts.
- Convertisseur dimmable déporté fourni.
- Compatible avec variateur fin de phase.

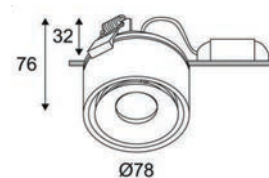

CLIC RDX MINI	MATIÈRE	LED	T°	LED Lumen	System Lumen	€	
DO365SW05	NOIR MAT	ALUMINIUM	8W	2700K	710 Lm	435 Lm	121,50 B
DO365SW30	BLANC MAT	ALUMINIUM	8W	2700K	710 Lm	435 Lm	121,50 B
DO365WW05	NOIR MAT	ALUMINIUM	8W	3000K	750 Lm	467 Lm	121,50 B
DO365WW30	BLANC MAT	ALUMINIUM	8W	3000K	750 Lm	467 Lm	121,50 B



NOIR MAT



BLANC MAT



### CLAC 1 MINI

DANS LA MÊME GAMME  
PAGE 220

## CLIC RDX

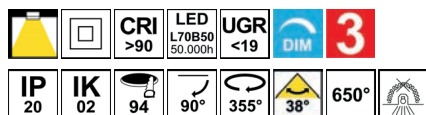

- Spot semi-encastré rond orientable.
- Fixation par ressorts.
- Convertisseur dimmable déporté fourni.
- Compatible avec variateur fin de phase.
- En option, convertisseur dimmable DALI-PUSH CD124 à commander séparément.

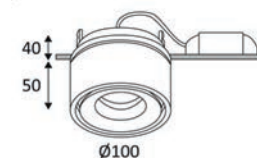

ALIMENTATION(S)	Watt Max	€
CD124	3-18W	87,50 B

CLIC RDX	MATIÈRE	LED	T°	LED Lumen	System Lumen	€	
DO224SW05	NOIR MAT	ALUMINIUM	13W	2700K	1120 Lm	798 Lm	172,00 B
DO224SW30	BLANC MAT	ALUMINIUM	13W	2700K	1120 Lm	798 Lm	172,00 B
DO224WW05	NOIR MAT	ALUMINIUM	13W	3000K	1180 Lm	900 Lm	180,30 B
DO224WW30	BLANC MAT	ALUMINIUM	13W	3000K	1180 Lm	900 Lm	180,30 B



NOIR MAT



BLANC MAT



### CLAC

DANS LA MÊME GAMME  
PAGE 221

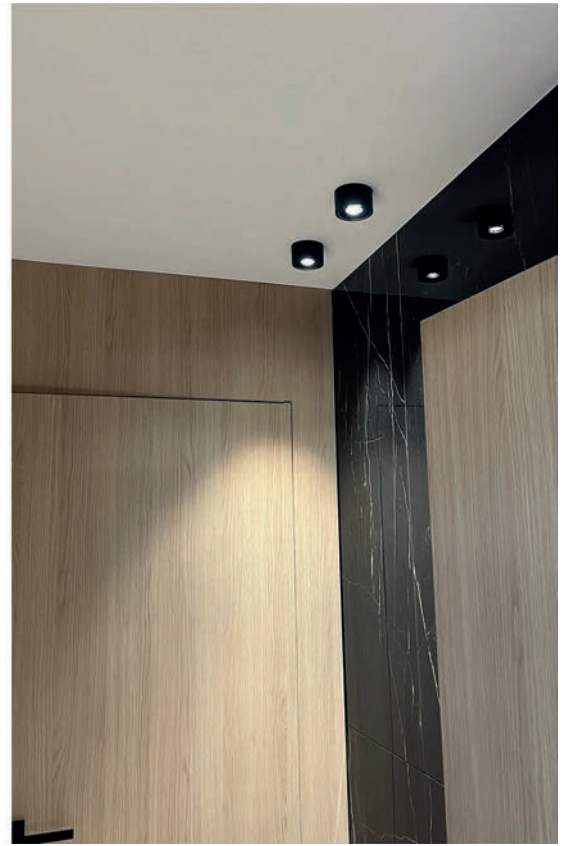

## EDDY RX

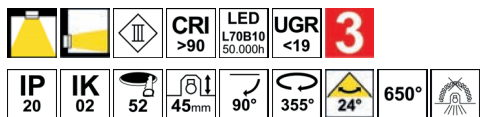

- Spot semi-encastré rond orientable.
- Fixation par ressorts.
- Convertisseur non dimmable déporté fourni.

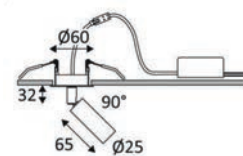

EDDY RX		MATIÈRE	LED	T°	LED Lumen	System Lumen	€
DO509WW05	■ NOIR MAT	ALUMINIUM	2W	3000K	205 Lm	145 Lm	62,80 B
DO509WW30	■ BLANC MAT	ALUMINIUM	2W	3000K	205 Lm	145 Lm	62,80 B



NOIR MAT

BLANC MAT





## JOY RX

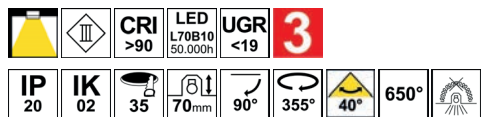

- Spot semi-encastré rond orientable.
- Fixation par ressorts.
- Convertisseur non dimmable déporté fourni.

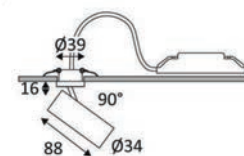

JOY RX		MATIÈRE	LED	T°	LED Lumen	System Lumen	€
DO510WW05	■ NOIR MAT	ALUMINIUM	4,5W	3000K	375 Lm	260 Lm	95,80 B
DO510WW30	■ BLANC MAT	ALUMINIUM	4,5W	3000K	375 Lm	260 Lm	95,80 B



NOIR MAT



BLANC MAT



## FILI 1 RX-B



- Spot semi-encastré rond orientable.
- Fixation par lamelles.
- Convertisseur non dimmable déporté fourni.
- En option, convertisseur dimmable DALI-PUSH CD123 à commander séparément.

ALIMENTATION(S)	Watt Max	€
CD123	3-18W	87,60 B



FILI 1 RX-B	MATIÈRE	LED	T°	LED Lumen	System Lumen	€	
DO246WW05	NOIR MAT	ALUMINIUM	10W	3000K	1010 Lm	651 Lm	163,80 B
DO246WW30	BLANC MAT	ALUMINIUM	10W	3000K	1010 Lm	651 Lm	163,80 B



NOIR MAT

BLANC MAT



**FILI 1 RX GU10 AUTO**

DANS LA MÊME GAMME  
PAGE 96





## FILI 5 RDX-B

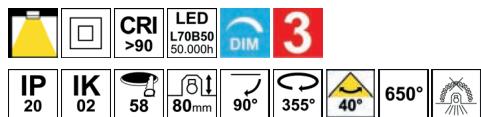

- Spot semi-encastré rond orientable.
- Fixation par lamelles.
- Livré avec réflecteur doré.
- Double bornier automatique.
- Convertisseur dimmable déporté fourni.
- Compatible avec variateur fin de phase.
- En option, convertisseur dimmable DALI-PUSH CD140 à commander séparément.

ALIMENTATION(S)	Watt Max	€
CD140	3-18W	100,90 B

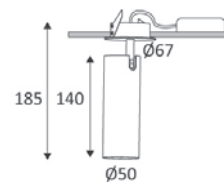

FILI 5 RDX-B	MATIÈRE	LED	T°	LED Lumen	System Lumen	€	
DO490WW05	NOIR MAT	ALUMINIUM	14W	3000K	1120 Lm	505 Lm	124,60 B
DO490WW30	BLANC MAT	ALUMINIUM	14W	3000K	1120 Lm	505 Lm	124,60 B



NOIR MAT

BLANC MAT



### FILI 5 RX-B GU10 AUTO

DANS LA MÊME GAMME  
PAGE 97



## DEAN RX

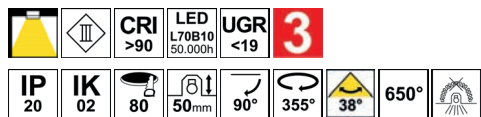

- Spot semi-encastré rond orientable.
- Fixation par ressorts.
- Convertisseur non dimmable déporté fourni.
- En option, convertisseur dimmable CD125 à commander séparément.

ALIMENTATION(S)	Watt Max	€
CD125	19-35W	68,00 B

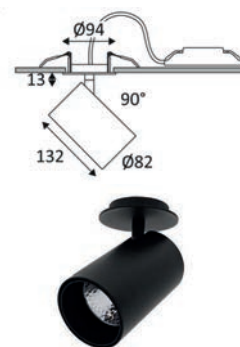

DEAN RX	MATIÈRE	LED	T°	LED Lumen	System Lumen	€	
DO511WW05	■ NOIR MAT	ALUMINIUM	26W	3000K	2370 Lm	1625 Lm	140,10 B
DO511WW30	■ BLANC MAT	ALUMINIUM	26W	3000K	2370 Lm	1625 Lm	140,10 B



NOIR MAT

BLANC MAT

## DEAN RDX PLUS

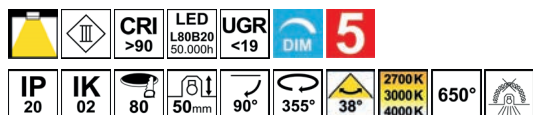

- Spot semi-encastré rond orientable 3 en 1.
- 2700K, 3000K ou 4000K au choix via un interrupteur sur le convertisseur.
- Fixation par ressorts.
- Convertisseur dimmable déporté fourni.
- Compatible avec variateur fin de phase.

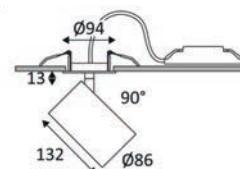

DEAN RDX PLUS	MATIÈRE	LED	T°	LED Lumen	System Lumen	€	
DO52605	■ NOIR MAT	ALUMINIUM	28W	2700-3000-4000K	2300 Lm (4000K)	1625 Lm (4000K)	180,30 B
DO52630	■ BLANC MAT	ALUMINIUM	28W	2700-3000-4000K	2300 Lm (4000K)	1625 Lm (4000K)	180,30 B



NOIR MAT

BLANC MAT





## KARL 1 RDX

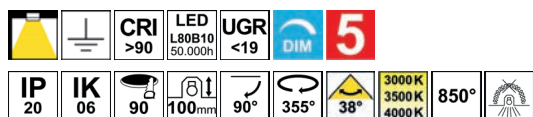

- Spot semi-encastré rond orientable 3 en 1.
- 3000K, 3500K ou 4000K au choix via un interrupteur à l'arrière du luminaire.
- Fixation par ressorts.
- Convertisseur dimmable déporté fourni.
- Compatible avec variateur fin de phase.

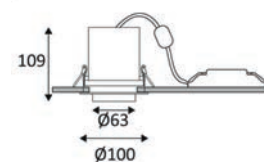

KARL 1 RDX	MATIÈRE	LED	T°	LED Lumen	System Lumen	€	
DO54205	NOIR MAT	ALUMINIUM	13W	3000-3500-4000K	1330 Lm (4000K)	960 Lm (4000K)	118,50 B
DO54230	BLANC MAT	ALUMINIUM	13W	3000-3500-4000K	1330 Lm (4000K)	960 Lm (4000K)	118,50 B



NOIR MAT



BLANC MAT

## KARL 2 RDX

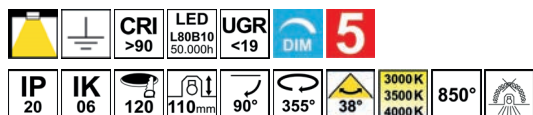

- Spot semi-encastré rond orientable 3 en 1.
- 3000K, 3500K ou 4000K au choix via un interrupteur à l'arrière du luminaire.
- Fixation par ressorts.
- Convertisseur dimmable déporté fourni.
- Compatible avec variateur fin de phase.

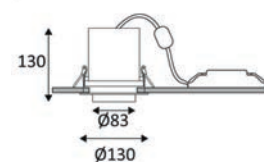

KARL 2 RDX	MATIÈRE	LED	T°	LED Lumen	System Lumen	€	
DO54305	NOIR MAT	ALUMINIUM	26W	3000-3500-4000K	2750 Lm (4000K)	2250 Lm (4000K)	156,60 B
DO54330	BLANC MAT	ALUMINIUM	26W	3000-3500-4000K	2750 Lm (4000K)	2250 Lm (4000K)	156,60 B



NOIR MAT



BLANC MAT



## SIRA R

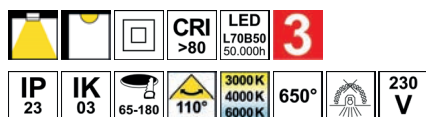

- Downlight rond fixe 3 en 1.
- Montage apparent ou semi-encastré.
- 3000K, 4000K ou 6000K au choix via un interrupteur à l'arrière du luminaire.
- Fixation par ressorts ajustables pour couvrir les diamètres d'encastrement de 65 à 180mm.
- Convertisseur non dimmable intégré dans l'appareil.



SIRA R	MATIÈRE	LED	T°	LED Lumen	System Lumen	€	
DO36630	BLANC MAT	COMPOSITE	18W	3000-4000-6000K	2150 Lm (4000K)	1599 Lm (4000K)	49,40 B

## SIRA R SENSOR IR

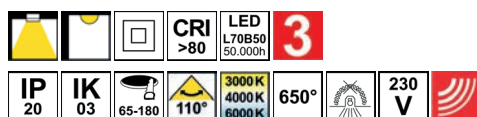

- Downlight rond fixe 3 en 1.
- Montage apparent ou semi-encastré.
- Multi-puissance : 12, 15 ou 18W au choix via un interrupteur à l'arrière du luminaire.
- 3000K, 4000K ou 6000K au choix via un interrupteur à l'arrière du luminaire.
- Avec détecteur IR 120°, zone de détection 3m de diamètre.
- Fixation par ressorts ajustables pour couvrir les diamètres d'encastrement de 65 à 180mm.
- Convertisseur non dimmable intégré dans l'appareil.

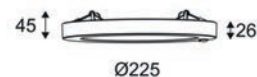

SIRA R SENSOR IR	MATIÈRE	LED	T°	LED Lumen	System Lumen	€	
DO49530	BLANC MAT	COMPOSITE	12W 15W 18W	3000-4000-6000K	1550 Lm (4000K) 1910 Lm (4000K) 2150 Lm (4000K)	1192 Lm (4000K) 1468 Lm (4000K) 1661 Lm (4000K)	86,50 B

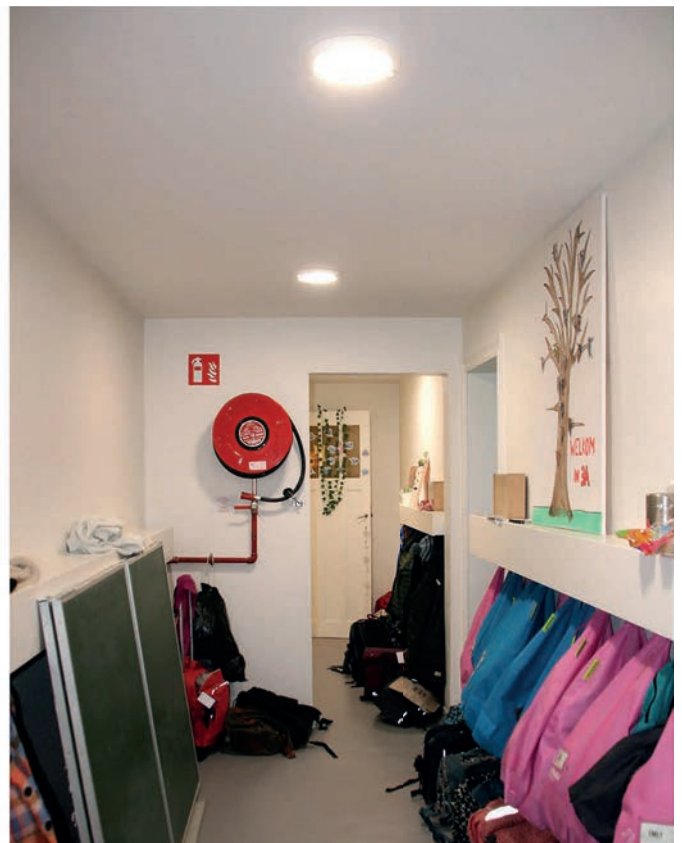
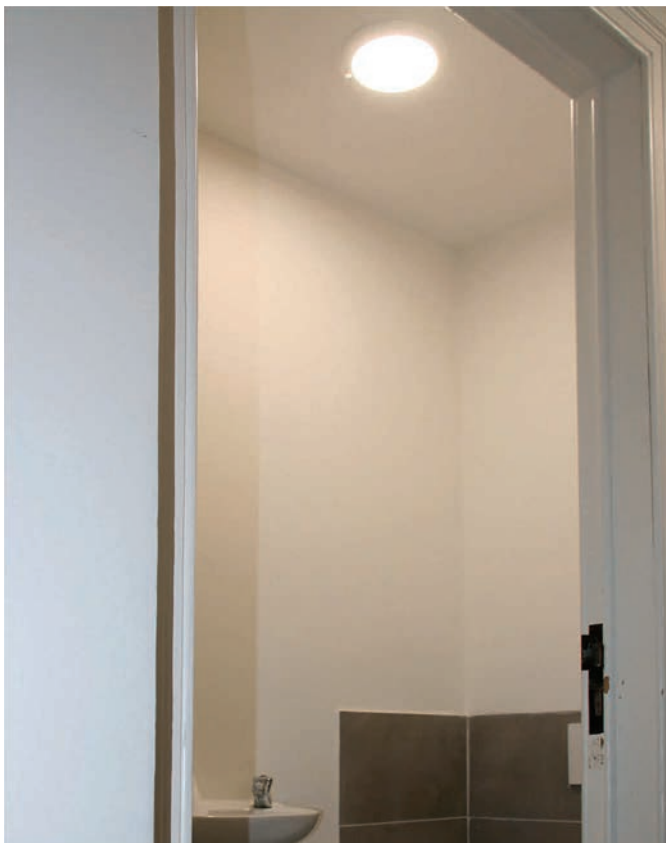

# INDIGO

LIGHTING



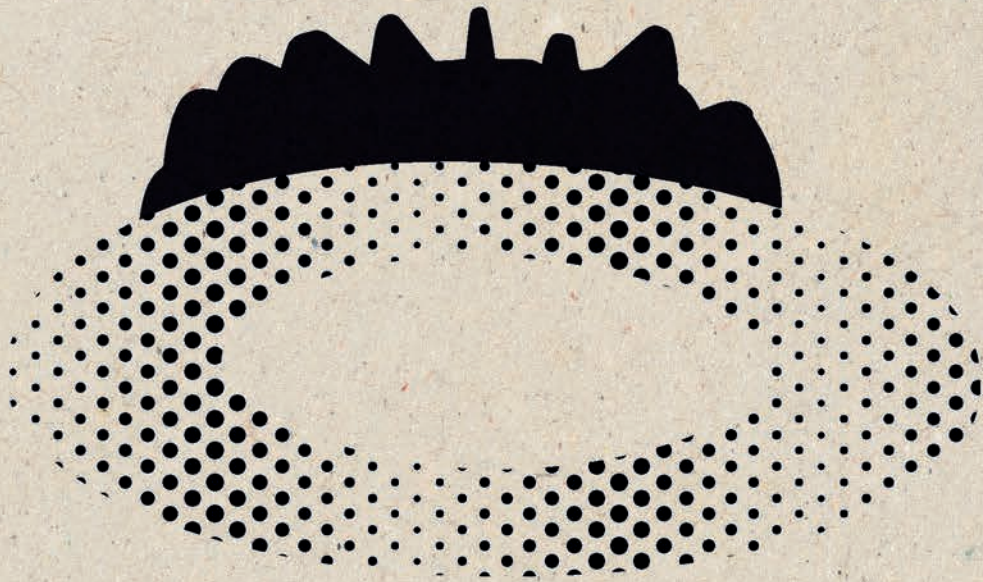

## **DOWNLIGHTS**

## DAX RD-230

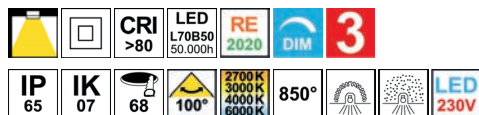

- Downlight encastré rond fixe 4 en 1.
- 2700K, 3000K, 4000K ou 6000K au choix via un interrupteur à l'arrière du luminaire.
- Fixation par ressorts.
- Peut être recouvert par un isolant déroulé ou soufflé.
- Double bornier automatique.
- Ne nécessite pas de convertisseur.
- Dimmable.
- Compatible avec variateur fin de phase.

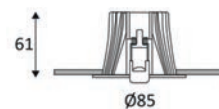

DAX RD-230	MATIÈRE	LED	T°	LED Lumen	System Lumen	€	
DO48730	BLANC MAT	COMPOSITE	6W	2700-3000-4000-6000K	850 Lm (4000K)	676 Lm (4000K)	29,90 B

## SENSO R-230



- Downlight encastré rond fixe 3 en 1.
- 2700K, 3000K ou 4000K au choix via un interrupteur à l'arrière du luminaire.
- Fixation par ressorts.
- Double bornier automatique.
- Avec détecteur IR 90°, zone de détection max. 5m de diamètre.
- Durée d'allumage de 3 minutes après détection.
- Fonctionne uniquement quand la luminosité est inférieure à 100 Lux.
- Ne nécessite pas de convertisseur.

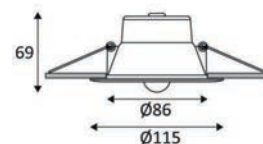

SENSO R-230	MATIÈRE	LED	T°	LED Lumen	System Lumen	€	
DO53605	NOIR MAT	COMPOSITE	9W	2700-3000-4000K	1800 Lm (4000K)	950 Lm (4000K)	46,40 B
DO53630	BLANC MAT	COMPOSITE	9W	2700-3000-4000K	1800 Lm (4000K)	950 Lm (4000K)	44,30 B



NOIR MAT



BLANC MAT





## TIGA 1 RD

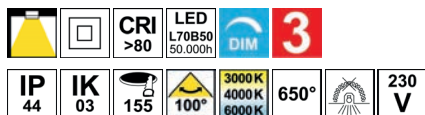

- Downlight encastré rond fixe 3 en 1.
- 3000K, 4000K ou 6000K au choix via un interrupteur à l'arrière du luminaire.
- Fixation par ressorts.
- Convertisseur dimmable intégré dans l'appareil.
- Compatible avec variateur fin de phase.

TIGA 1 RD	MATIÈRE	LED	T°	LED Lumen	System Lumen	€	
DO35630	BLANC MAT	COMPOSITE	12W	3000-4000-6000K	1600 Lm (4000K)	985 Lm (4000K)	44,30 B

## TIGA 2 RD

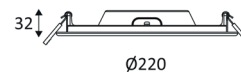
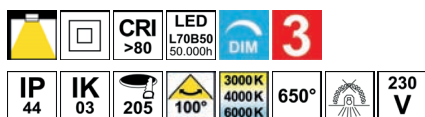

- Downlight encastré rond fixe 3 en 1.
- 3000K, 4000K ou 6000K au choix via un interrupteur à l'arrière du luminaire.
- Fixation par ressorts.
- Convertisseur dimmable intégré dans l'appareil.
- Compatible avec variateur fin de phase.

TIGA 2 RD	MATIÈRE	LED	T°	LED Lumen	System Lumen	€	
DO35730	BLANC MAT	COMPOSITE	18W	3000-4000-6000K	2350 Lm (4000K)	1622 Lm (4000K)	49,40 B

## TIGA 3 RD

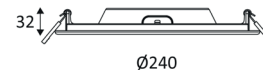
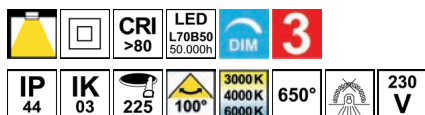

- Downlight encastré rond fixe 3 en 1.
- 3000K, 4000K ou 6000K au choix via un interrupteur à l'arrière du luminaire.
- Fixation par ressorts.
- Convertisseur dimmable intégré dans l'appareil.
- Compatible avec variateur fin de phase.

TIGA 3 RD	MATIÈRE	LED	T°	LED Lumen	System Lumen	€	
DO35830	BLANC MAT	COMPOSITE	24W	3000-4000-6000K	2870 Lm (4000K)	2083 Lm (4000K)	55,60 B



## THEA LITE CSP 1

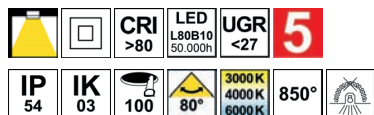
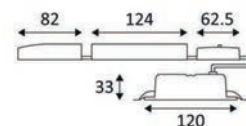

- Downlight encastré rond fixe 3 en 1.
- 3000K, 4000K ou 6000K au choix via un interrupteur à l'arrière du luminaire.
- Fixation par ressorts.
- Double bornier automatique.
- Connecteur Plug & Play inclus.
- Convertisseur non dimmable déporté fourni ou convertisseur à commander séparément.
- Convertisseur dimmable DALI, Push-Dim et 0-10V en option.
- Kit d'éclairage de secours en option.

THEA LITE CSP 1	MATIÈRE	LED	T°	LED Lumen	System Lumen	€
<b>CONVERTISSEUR INCLUS</b>						
THL1N	BLANC	ALUMINIUM	10W	3000-4000-6000K	1600 Lm (4000K) 1200 Lm (4000K)	35,00 A
<b>CONVERTISSEUR EXCLU</b>						
THL1X	BLANC	ALUMINIUM	10W	3000-4000-6000K	1600 Lm (4000K) 1200 Lm (4000K)	28,00 A

ACCESSOIRES	DESCRIPTION	L (mm)	€
PS250600MA	DRIVER 13-29W 250-600mA CC DALI PUSH-DIM 0-10V	125	77,90 A
LEDEP10	KIT ECLAIRAGE DE SECOURS	200	233,10 A





## THEA LITE CSP 2

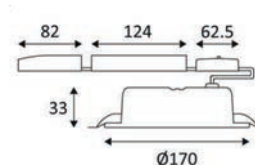
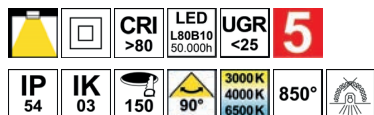

- Downlight encastré rond fixe 3 en 1.
- 3000K, 4000K ou 6500K au choix via un interrupteur à l'arrière du luminaire.
- Fixation par ressorts.
- Double bornier automatique.
- Connecteur Plug & Play inclus.
- Convertisseur non dimmable déporté fourni ou convertisseur à commander séparément.
- Convertisseur dimmable DALI, Push-Dim et 0-10V en option.
- Kit d'éclairage de secours en option.

THEA LITE CSP 2	MATIÈRE	LED	T°	LED Lumen	System Lumen	€
<b>CONVERTISSEUR INCLUS</b>						
THL2N	BLANC	ALUMINIUM	14W	3000-4000-6500K	2000 Lm (4000K)	1680 Lm (4000K) <b>45,00</b> A
<b>CONVERTISSEUR EXCLU</b>						
THL2X	BLANC	ALUMINIUM	14W	3000-4000-6500K	2000 Lm (4000K)	1680 Lm (4000K) <b>36,10</b> A

ACCESSOIRES	DESCRIPTION	L (mm)	€
PS250600MA	DRIVER 13-29W 250-600mA CC DALI PUSH-DIM 0-10V	125	<b>77,90</b> A
LEDEP10	KIT ECLAIRAGE DE SECOURS	200	<b>233,10</b> A

## THEA LITE CSP 3

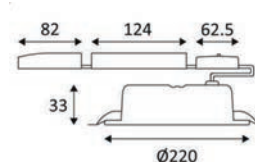
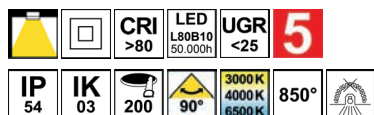

- Downlight encastré rond fixe 3 en 1.
- 3000K, 4000K ou 6500K au choix via un interrupteur à l'arrière du luminaire.
- Fixation par ressorts.
- Double bornier automatique.
- Connecteur Plug & Play inclus.
- Convertisseur non dimmable déporté fourni ou convertisseur à commander séparément.
- Convertisseur dimmable DALI, Push-Dim et 0-10V en option.
- Kit d'éclairage de secours en option.

THEA LITE CSP 3	MATIÈRE	LED	T°	LED Lumen	System Lumen	€
<b>CONVERTISSEUR INCLUS</b>						
THL3N	BLANC	ALUMINIUM	20W	3000-4000-6500K	2950 Lm (4000K)	2400 Lm (4000K) <b>49,00</b> A
<b>CONVERTISSEUR EXCLU</b>						
THL3X	BLANC	ALUMINIUM	20W	3000-4000-6500K	2950 Lm (4000K)	2400 Lm (4000K) <b>44,00</b> A

ACCESSOIRES	DESCRIPTION	L (mm)	€
PS250600MA	DRIVER 13-29W 250-600mA CC DALI PUSH-DIM 0-10V	125	<b>77,90</b> A
LEDEP10	KIT ECLAIRAGE DE SECOURS	200	<b>233,10</b> A

## FOX 2 RD

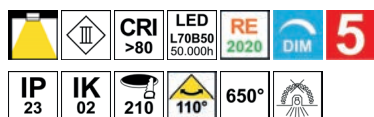

- Downlight encastré rond fixe.
- Fixation par ressorts.
- Convertisseur dimmable déporté fourni.
- Compatible avec variateur fin de phase.



FOX 2 RD		MATIÈRE	LED	T°	LED Lumen	System Lumen	€
DO102WW05	■ NOIR MAT	FONTE D'ALUMINIUM	19W	3000K	2700 Lm	1725 Lm	84,50 B
DO102WW30	■ BLANC MAT	FONTE D'ALUMINIUM	19W	3000K	2700 Lm	1725 Lm	84,50 B
DO102NW05	■ NOIR MAT	FONTE D'ALUMINIUM	19W	4000K	2800 Lm	1805 Lm	84,50 B
DO102NW30	■ BLANC MAT	FONTE D'ALUMINIUM	19W	4000K	2800 Lm	1805 Lm	84,50 B



NOIR MAT

BLANC MAT

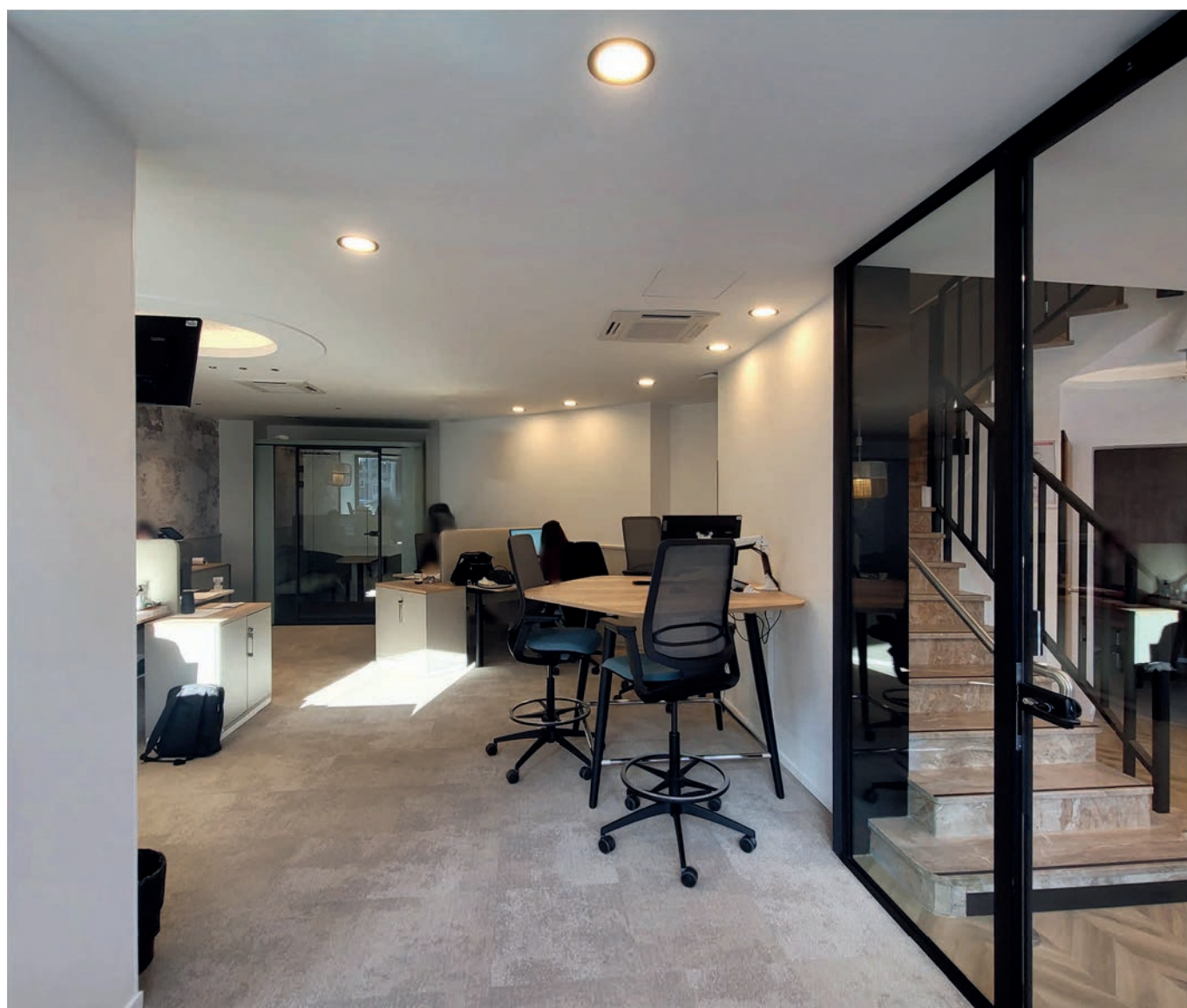



## CURLI 1 RD

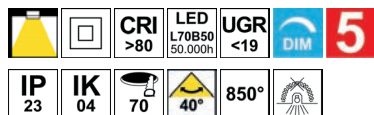

- Downlight encastré rond fixe.
- Réflecteur basse luminance.
- Fixation par ressorts.
- Convertisseur dimmable déporté fourni.
- Compatible avec variateur début et fin de phase.
- En option, convertisseur dimmable DALI-PUSH CD123 à commander séparément.

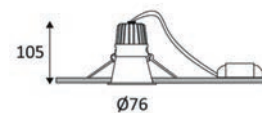

ALIMENTATION(S)	Watt Max	€
CD123	3-18W	87,60 B

CURLI 1 RD		MATIÈRE	LED	T°	LED Lumen	System Lumen	€
DO287WW30	BLANC MAT	FRONT D'ALUMINIUM	10W	3000K	1050 Lm	789 Lm	90,60 B
DO287NW30	BLANC MAT	FRONT D'ALUMINIUM	10W	4000K	1140 Lm	870 Lm	90,60 B

ACCESSOIRES		DESCRIPTION		€
DO42030	BLANC MAT	CURLI 1 RD BAGUE CARREE 85X85mm		6,20 B

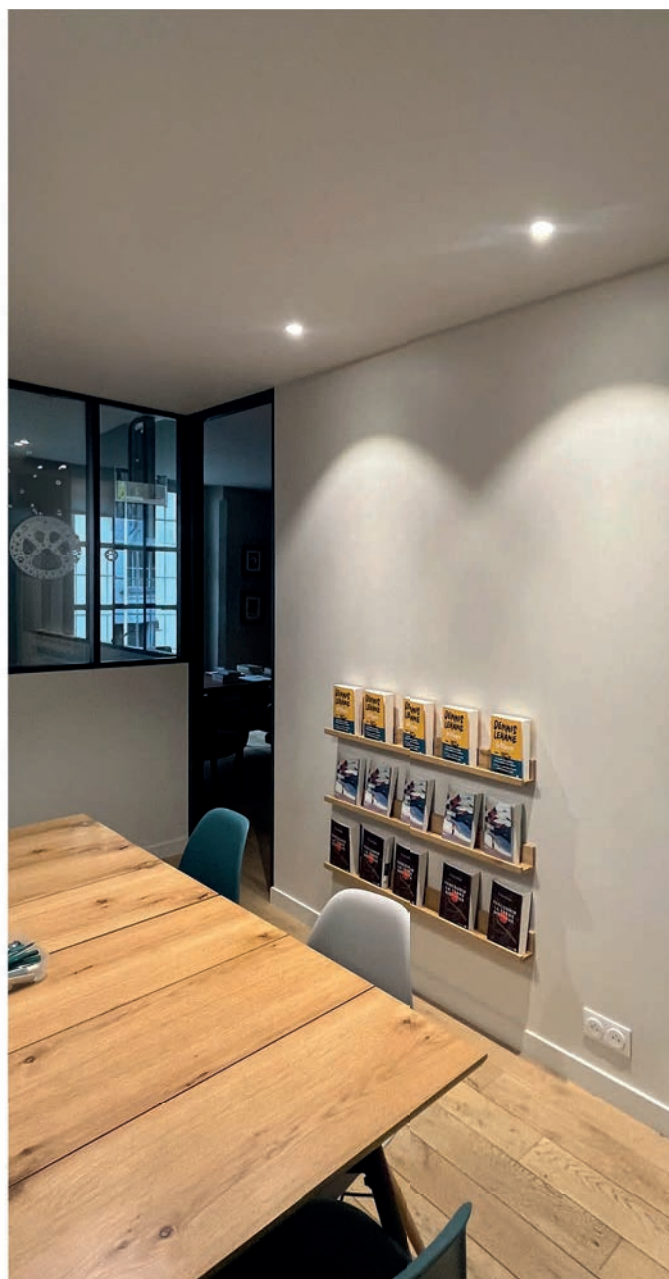





## CURLI 2 RD

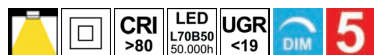

- Downlight encastré rond fixe.
- Réflecteur basse luminance.
- Fixation par ressorts.
- Convertisseur dimmable déporté fourni.
- Compatible avec variateur début et fin de phase.
- En option, convertisseur dimmable DALI-PUSH CD140 à commander séparément.

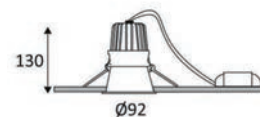

ALIMENTATION(S)	Watt Max	€
CD140	3-18W	100,90 B

CURLI 2 RD	MATÈRE	LED	T°	LED Lumen	System Lumen	€	
DO288WW30	BLANC MAT	FONTE D'ALUMINIUM	15W	3000K	1520 Lm	1215 Lm	105,10 B
DO288NW30	BLANC MAT	FONTE D'ALUMINIUM	15W	4000K	1580 Lm	1224 Lm	105,10 B

ACCESSOIRES	DESCRIPTION	€
DO42130	BLANC MAT CURLI 2 RD BAGUE CARREE 105x105mm	7,20 B

## CURLI 3 RD



- Downlight encastré rond fixe.
- Réflecteur basse luminance.
- Fixation par ressorts.
- Convertisseur dimmable déporté fourni.
- Compatible avec variateur début et fin de phase.
- En option, convertisseur dimmable DALI-PUSH CD126 à commander séparément.

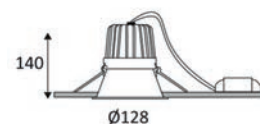

ALIMENTATION(S)	Watt Max	€
CD126	4-27W	98,90 B

CURLI 3 RD	MATÈRE	LED	T°	LED Lumen	System Lumen	€	
DO289WW30	BLANC MAT	FONTE D'ALUMINIUM	25W	3000K	2450 Lm	1934 Lm	132,90 B
DO289NW30	BLANC MAT	FONTE D'ALUMINIUM	25W	4000K	2580 Lm	2181 Lm	132,90 B

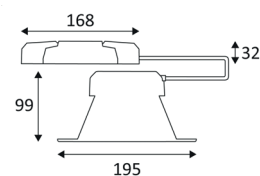
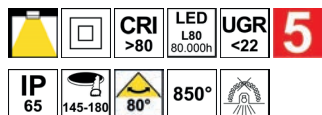

ACCESSOIRES	DESCRIPTION	€
DO42230	BLANC MAT CURLI 3 RD BAGUE CARREE 145x145mm	14,40 B

## THEA PRO 1



- Downlight encastré rond fixe.
- Réflecteur basse luminance.
- Réflecteur pour UGR<19 en option.
- Fixation par ressorts.
- Double bornier automatique.
- Connecteur Plug & Play inclus.
- Convertisseur non dimmable déporté fourni ou convertisseur à commander séparément.
- Convertisseur dimmable DALI / Push-Dim en option.
- Kit d'éclairage de secours en option.

THEA PRO 1	MATIÈRE	LED	T°	LED Lumen	System Lumen	€
<b>CONVERTISSEUR INCLUS</b>						
<b>THP1N</b>	BLANC	ALUMINIUM 10W	4000K	1600 Lm	1400 Lm	<b>55,00</b> A
<b>THP2N</b>	BLANC	ALUMINIUM 14W	4000K	2400 Lm	2000 Lm	<b>58,00</b> A
<b>CONVERTISSEUR EXCLU</b>						
<b>THP1X</b>	BLANC	ALUMINIUM 10W	4000K	1600 Lm	1400 Lm	<b>49,00</b> A
<b>THP2X</b>	BLANC	ALUMINIUM 14W	4000K	2400 Lm	2000 Lm	<b>53,00</b> A

ACCESSOIRES	DESCRIPTION	L (mm)	€
<b>THP1DD</b>	DRIVER DALI PUSH-DIM THP1		<b>47,00</b> A
<b>THP23DD</b>	DRIVER DALI PUSH-DIM THP2 / THP3		<b>47,00</b> A
<b>THP12UGR</b>	REFLECTEUR UGR<19 THP1 / THP2		<b>18,00</b> A
<b>LEDEP10</b>	KIT ECLAIRAGE DE SECOURS	200 	<b>233,10</b> A



## THEA PRO 2

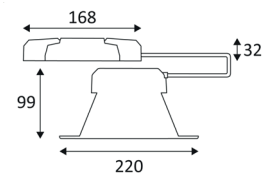

NEW

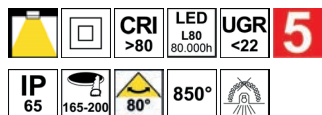

- Downlight encastré rond fixe.
- Réflecteur basse luminance.
- Réflecteur pour UGR<19 en option.
- Fixation par ressorts.
- Double bornier automatique.
- Connecteur Plug & Play inclus.
- Convertisseur non dimmable déporté fourni ou convertisseur à commander séparément.
- Convertisseur dimmable DALI / Push-Dim en option.
- Kit d'éclairage de secours en option.

THEA PRO 2	MATIÈRE	LED	T°	LED Lumen	System Lumen	€
<b>CONVERTISSEUR INCLUS</b>						
<b>THP3N</b>	NEW BLANC	ALUMINIUM	14W	4000K	2400 Lm	2000 Lm 65,00 A
<b>THP4N</b>	NEW BLANC	ALUMINIUM	25W	4000K	4400 Lm	3500 Lm 72,00 A
<b>CONVERTISSEUR EXCLU</b>						
<b>THP3X</b>	NEW BLANC	ALUMINIUM	14W	4000K	2400 Lm	2000 Lm 60,00 A
<b>THP4X</b>	NEW BLANC	ALUMINIUM	25W	4000K	4400 Lm	3500 Lm 67,00 A
<b>ACCESSOIRES</b>	<b>DESCRIPTION</b>	<b>L (mm)</b>				<b>€</b>
<b>THP23DD</b>	NEW DRIVER DALI PUSH-DIM THP2 / THP3					47,00 A
<b>THP4DD</b>	NEW DRIVER DALI PUSH-DIM THP4					47,00 A
<b>THP34UGR</b>	NEW REFLECTEUR UGR<19 THP3 / THP4					23,00 A
<b>LEDEP10</b>	NEW KIT ECLAIRAGE DE SECOURS	200				233,10 A

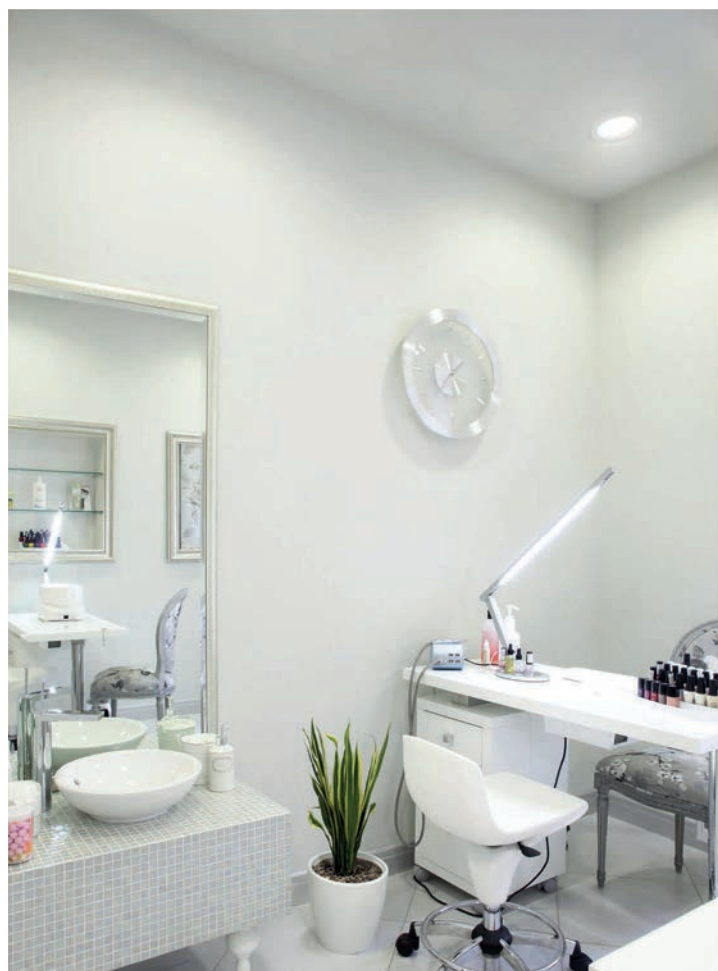

## LYON 1 R

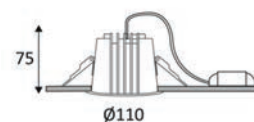
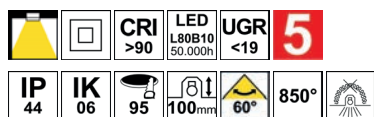

- Downlight encastré rond fixe.
- Réflecteur basse luminance.
- Fixation par ressorts.
- Convertisseur non-dimmable ou dimmable DALI-push déporté fourni.

LYON 1 R	MATIÈRE	LED	T°	LED Lumen	System Lumen	€
<b>NON DIMMABLE</b>						
DO538WW05	NOIR MAT	ALUMINIUM	15W	3000K	1875 Lm	1515 Lm 74,20 B
DO538WW17	NOIR MAT - ARGENT	ALUMINIUM	15W	3000K	1875 Lm	1590 Lm 74,20 B
DO538WW30	BLANC MAT	ALUMINIUM	15W	3000K	1875 Lm	1590 Lm 74,20 B
DO538WW53	BLANC MAT - ARGENT	ALUMINIUM	15W	3000K	1875 Lm	1590 Lm 74,20 B
DO538NW05	NOIR MAT	ALUMINIUM	15W	4000K	1920 Lm	1545 Lm 74,20 B
DO538NW17	NOIR MAT - ARGENT	ALUMINIUM	15W	4000K	1920 Lm	1625 Lm 74,20 B
DO538NW30	BLANC MAT	ALUMINIUM	15W	4000K	1920 Lm	1625 Lm 74,20 B
DO538NW53	BLANC MAT - ARGENT	ALUMINIUM	15W	4000K	1920 Lm	1625 Lm 74,20 B
<b>DIMMABLE DALI</b>						
DO538WW05DA	NOIR MAT	ALUMINIUM	15W	3000K	1875 Lm	1515 Lm 145,20 B
DO538WW17DA	NOIR MAT - ARGENT	ALUMINIUM	15W	3000K	1875 Lm	1590 Lm 145,20 B
DO538WW30DA	BLANC MAT	ALUMINIUM	15W	3000K	1875 Lm	1590 Lm 145,20 B
DO538WW53DA	BLANC MAT - ARGENT	ALUMINIUM	15W	3000K	1875 Lm	1590 Lm 145,20 B
DO538NW05DA	NOIR MAT	ALUMINIUM	15W	4000K	1920 Lm	1545 Lm 145,20 B
DO538NW17DA	NOIR MAT - ARGENT	ALUMINIUM	15W	4000K	1920 Lm	1625 Lm 145,20 B
DO538NW30DA	BLANC MAT	ALUMINIUM	15W	4000K	1920 Lm	1625 Lm 145,20 B
DO538NW53DA	BLANC MAT - ARGENT	ALUMINIUM	15W	4000K	1920 Lm	1625 Lm 145,20 B



NOIR MAT



NOIR MAT - ARGENT



BLANC MAT



BLANC MAT - ARGENT





## LYON 2 R

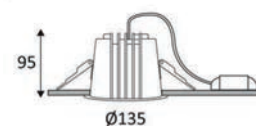
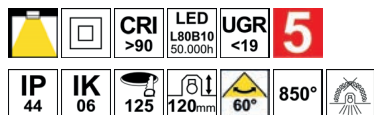

- Downlight encastré rond fixe.
- Réflecteur basse luminance.
- Fixation par ressorts.
- Convertisseur non-dimmable ou dimmable DALI-push déporté fourni.

LYON 2 R	MATIÈRE	LED	T°	LED Lumen	System Lumen	€
<b>NON DIMMABLE</b>						
DO539WW05	NOIR MAT	ALUMINIUM	25W	3000K	3000 Lm	2535 Lm 100,90 B
DO539WW17	NOIR MAT - ARGENT	ALUMINIUM	25W	3000K	3000 Lm	2670 Lm 100,90 B
DO539WW30	BLANC MAT	ALUMINIUM	25W	3000K	3000 Lm	2670 Lm 100,90 B
DO539WW53	BLANC MAT - ARGENT	ALUMINIUM	25W	3000K	3000 Lm	2670 Lm 100,90 B
DO539NW05	NOIR MAT	ALUMINIUM	25W	4000K	3070 Lm	2590 Lm 100,90 B
DO539NW17	NOIR MAT - ARGENT	ALUMINIUM	25W	4000K	3070 Lm	2750 Lm 100,90 B
DO539NW30	BLANC MAT	ALUMINIUM	25W	4000K	3070 Lm	2750 Lm 100,90 B
DO539NW53	BLANC MAT - ARGENT	ALUMINIUM	25W	4000K	3070 Lm	2750 Lm 100,90 B
<b>DIMMABLE DALI</b>						
DO539WW05DA	NOIR MAT	ALUMINIUM	25W	3000K	3000 Lm	2535 Lm 175,10 B
DO539WW17DA	NOIR MAT - ARGENT	ALUMINIUM	25W	3000K	3000 Lm	2670 Lm 175,10 B
DO539WW30DA	BLANC MAT	ALUMINIUM	25W	3000K	3000 Lm	2670 Lm 175,10 B
DO539WW53DA	BLANC MAT - ARGENT	ALUMINIUM	25W	3000K	3000 Lm	2670 Lm 175,10 B
DO539NW05DA	NOIR MAT	ALUMINIUM	25W	4000K	3070 Lm	2590 Lm 175,10 B
DO539NW17DA	NOIR MAT - ARGENT	ALUMINIUM	25W	4000K	3070 Lm	2750 Lm 175,10 B
DO539NW30DA	BLANC MAT	ALUMINIUM	25W	4000K	3070 Lm	2750 Lm 175,10 B
DO539NW53DA	BLANC MAT - ARGENT	ALUMINIUM	25W	4000K	3070 Lm	2750 Lm 175,10 B



NOIR MAT



NOIR MAT - ARGENT



BLANC MAT



BLANC MAT - ARGENT



## LYON 3 R

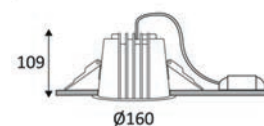
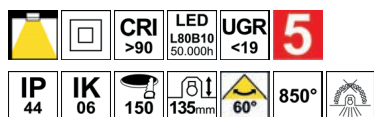

- Downlight encastré rond fixe.
- Réflecteur basse luminance.
- Fixation par ressorts.
- Convertisseur non-dimmable ou dimmable DALI-push déporté fourni.

LYON 3 R	MATIÈRE	LED	T°	LED Lumen	System Lumen	€
<b>NON DIMMABLE</b>						
DO540WW05	NOIR MAT	ALUMINIUM	30W	3000K	4000 Lm	3020 Lm 124,60 B
DO540WW17	NOIR MAT - ARGENT	ALUMINIUM	30W	3000K	4000 Lm	3180 Lm 124,60 B
DO540WW30	BLANC MAT	ALUMINIUM	30W	3000K	4000 Lm	3180 Lm 124,60 B
DO540WW53	BLANC MAT - ARGENT	ALUMINIUM	30W	3000K	4000 Lm	3180 Lm 124,60 B
DO540NW05	NOIR MAT	ALUMINIUM	30W	4000K	4100 Lm	3085 Lm 124,60 B
DO540NW17	NOIR MAT - ARGENT	ALUMINIUM	30W	4000K	4100 Lm	3275 Lm 124,60 B
DO540NW30	BLANC MAT	ALUMINIUM	30W	4000K	4100 Lm	3275 Lm 124,60 B
DO540NW53	BLANC MAT - ARGENT	ALUMINIUM	30W	4000K	4100 Lm	3275 Lm 124,60 B
<b>DIMMABLE DALI</b>						
DO540WW05DA	NOIR MAT	ALUMINIUM	30W	3000K	4000 Lm	3020 Lm 223,50 B
DO540WW17DA	NOIR MAT - ARGENT	ALUMINIUM	30W	3000K	4000 Lm	3180 Lm 223,50 B
DO540WW30DA	BLANC MAT	ALUMINIUM	30W	3000K	4000 Lm	3180 Lm 223,50 B
DO540WW53DA	BLANC MAT - ARGENT	ALUMINIUM	30W	3000K	4000 Lm	3180 Lm 223,50 B
DO540NW05DA	NOIR MAT	ALUMINIUM	30W	4000K	4100 Lm	3085 Lm 223,50 B
DO540NW17DA	NOIR MAT - ARGENT	ALUMINIUM	30W	4000K	4100 Lm	3275 Lm 223,50 B
DO540NW30DA	BLANC MAT	ALUMINIUM	30W	4000K	4100 Lm	3275 Lm 223,50 B
DO540NW53DA	BLANC MAT - ARGENT	ALUMINIUM	30W	4000K	4100 Lm	3275 Lm 223,50 B

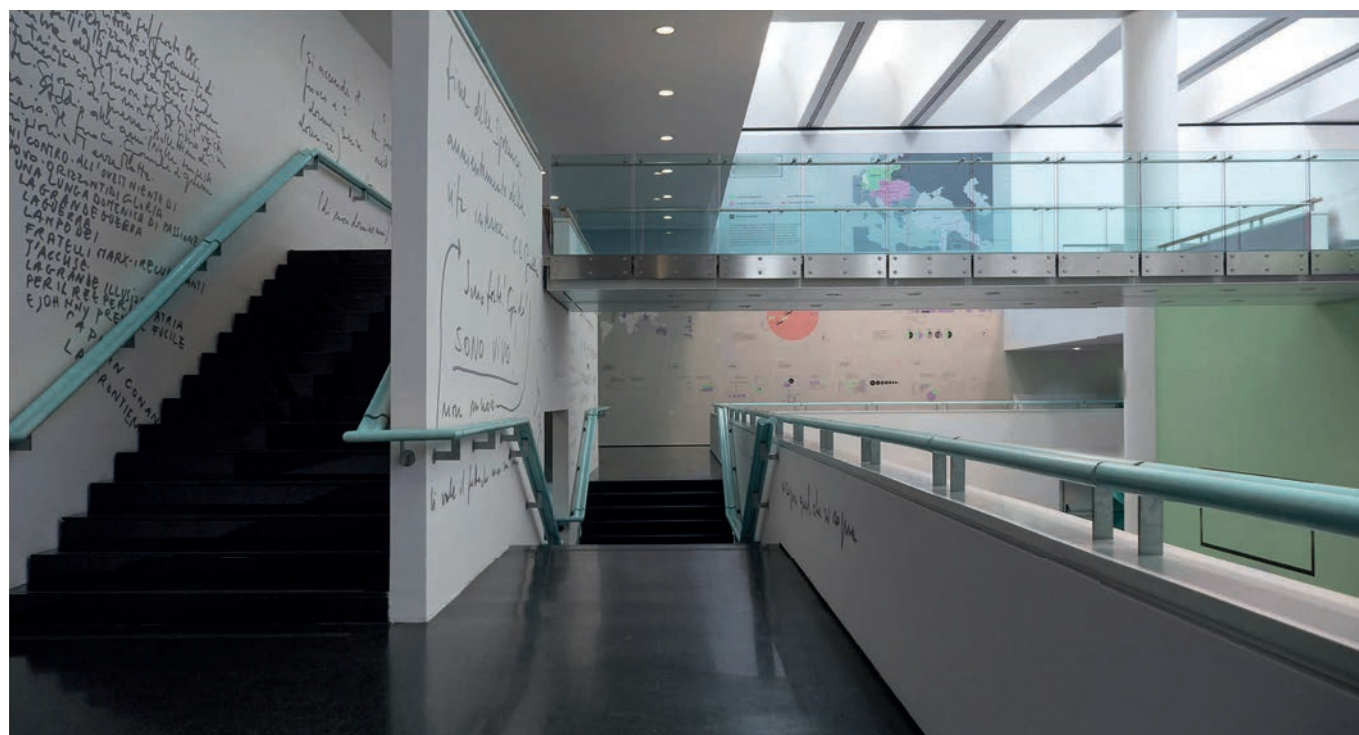



## LYON 4 R

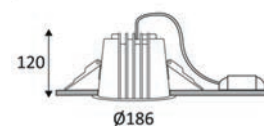
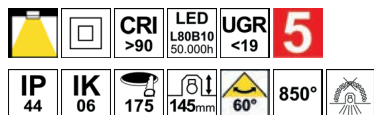

- Downlight encastré rond fixe.
- Réflecteur basse luminance.
- Fixation par ressorts.
- Convertisseur non-dimmable ou dimmable DALI-push déporté fourni.

LYON 4 R	MATIÈRE	LED	T°	LED Lumen	System Lumen	€
<b>NON DIMMABLE</b>						
DO541WW05	NOIR MAT	ALUMINIUM	40W	3000K	5000 Lm	3835 Lm 140,10 B
DO541WW17	NOIR MAT - ARGENT	ALUMINIUM	40W	3000K	5000 Lm	4035 Lm 140,10 B
DO541WW30	BLANC MAT	ALUMINIUM	40W	3000K	5000 Lm	4035 Lm 140,10 B
DO541WW53	BLANC MAT - ARGENT	ALUMINIUM	40W	3000K	5000 Lm	4035 Lm 140,10 B
DO541NW05	NOIR MAT	ALUMINIUM	40W	4000K	5120 Lm	3915 Lm 140,10 B
DO541NW17	NOIR MAT - ARGENT	ALUMINIUM	40W	4000K	5120 Lm	4160 Lm 140,10 B
DO541NW30	BLANC MAT	ALUMINIUM	40W	4000K	5120 Lm	4160 Lm 140,10 B
DO541NW53	BLANC MAT - ARGENT	ALUMINIUM	40W	4000K	5120 Lm	4160 Lm 140,10 B
<b>DIMMABLE DALI</b>						
DO541WW05DA	NOIR MAT	ALUMINIUM	40W	3000K	5000 Lm	3835 Lm 240,00 B
DO541WW17DA	NOIR MAT - ARGENT	ALUMINIUM	40W	3000K	5000 Lm	4035 Lm 240,00 B
DO541WW30DA	BLANC MAT	ALUMINIUM	40W	3000K	5000 Lm	4035 Lm 240,00 B
DO541WW53DA	BLANC MAT - ARGENT	ALUMINIUM	40W	3000K	5000 Lm	4035 Lm 240,00 B
DO541NW05DA	NOIR MAT	ALUMINIUM	40W	4000K	5120 Lm	3915 Lm 240,00 B
DO541NW17DA	NOIR MAT - ARGENT	ALUMINIUM	40W	4000K	5120 Lm	4160 Lm 240,00 B
DO541NW30DA	BLANC MAT	ALUMINIUM	40W	4000K	5120 Lm	4160 Lm 240,00 B
DO541NW53DA	BLANC MAT - ARGENT	ALUMINIUM	40W	4000K	5120 Lm	4160 Lm 240,00 B



## IZA 1 SDX

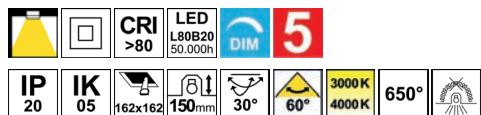

- Downlight encastré carré orientable 2 en 1.
- 3000K ou 4000K au choix via un interrupteur à l'arrière du luminaire.
- Fixation par ressorts.
- Convertisseur dimmable déporté fourni.
- Compatible avec variateur début et fin de phase.

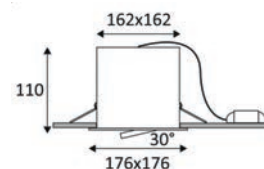

IZA 1 SDX		MATIÈRE	LED	T°	LED Lumen	System Lumen	€
DO53105	■ NOIR MAT	ALUMINIUM	24W	3000-4000K	3360 Lm (4000K)	2645 Lm (4000K)	162,70 B
DO53130	■ BLANC MAT	ALUMINIUM	24W	3000-4000K	2100 Lm (4000K)	1790 Lm (4000K)	162,70 B



NOIR MAT



BLANC MAT

## IZA 2 SDX

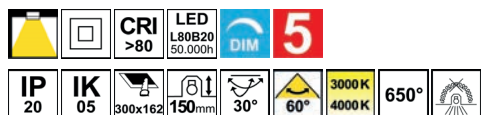

- Downlight encastré rectangulaire orientable 2 en 1.
- 3000K ou 4000K au choix via un interrupteur à l'arrière du luminaire.
- Fixation par ressorts.
- Convertisseurs dimmables déportés fournis.
- Compatible avec variateur début et fin de phase.

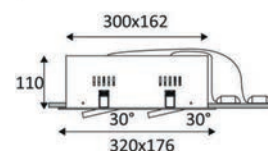

IZA 2 SDX		MATIÈRE	LED	T°	LED Lumen	System Lumen	€
DO53205	■ NOIR MAT	ALUMINIUM	2x24W	3000-4000K	2x3360 Lm (4000K)	2x2645 Lm (4000K)	288,40 B
DO53230	■ BLANC MAT	ALUMINIUM	2x24W	3000-4000K	2x2100 Lm (4000K)	2x1790 Lm (4000K)	288,40 B



NOIR MAT



BLANC MAT



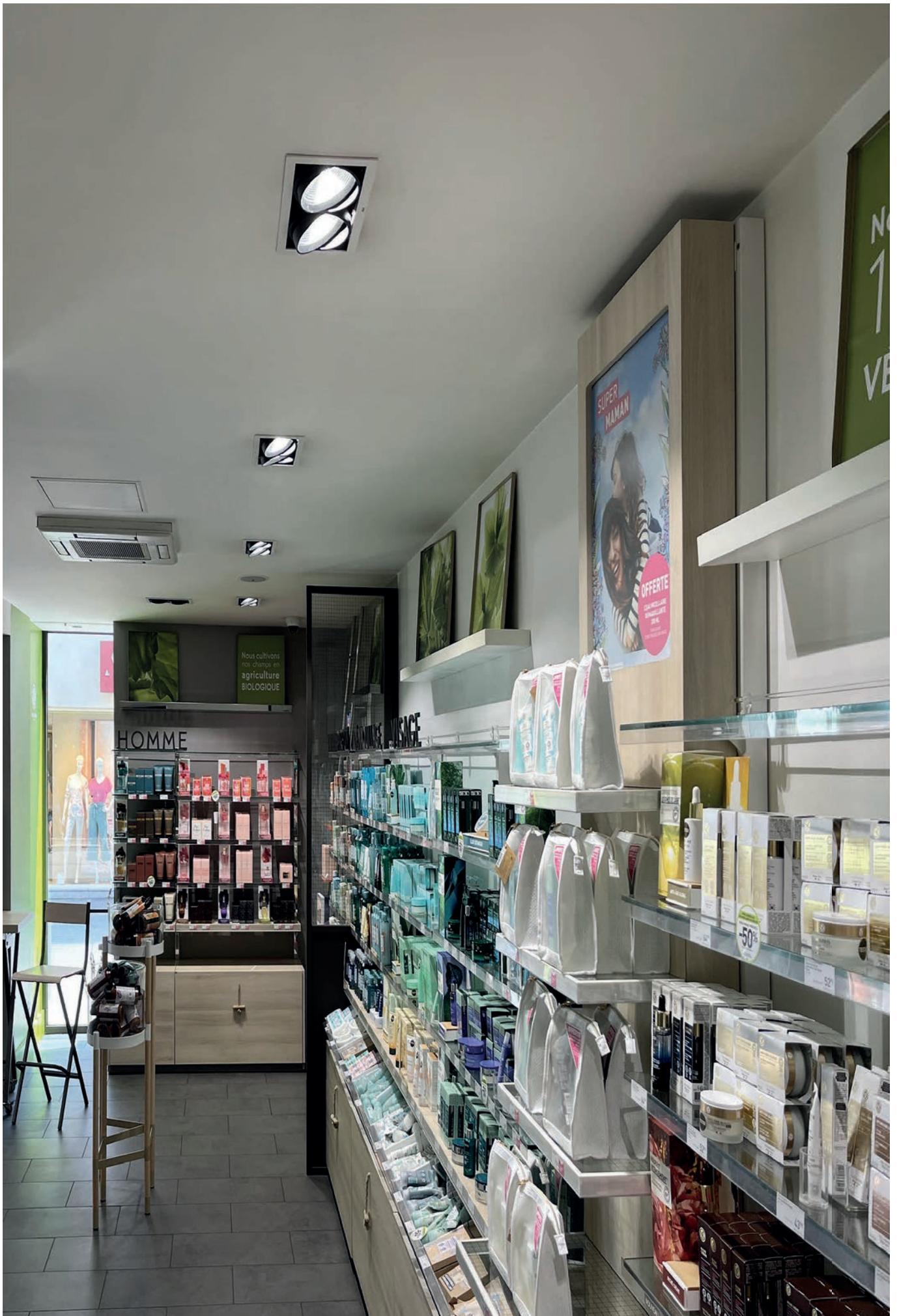

## AL1016 RX

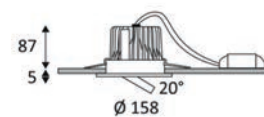
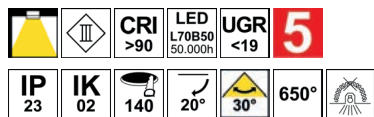

- Downlight encastré rond orientable.
- Fixation par ressorts
- Convertisseur non dimmable déporté fourni.
- En option, convertisseur dimmable DALI, Push-Dim et 1-10V à commander séparément.

ALIMENTATION(S)		Watt Max	€
PSDAL700M	<b>NEW</b>	3-50W	182,40 A

AL1016 RX		MATIÈRE	LED	T°	LED Lumen	System Lumen	€
DO107WW30	BLANC MAT	FONTE D'ALUMINIUM	26W	3000K	2350 Lm	2050 Lm	224,50 B
DO107NW30	BLANC MAT	FONTE D'ALUMINIUM	26W	4000K	2450 Lm	2140 Lm	224,50 B





## SPIRA 1 RX PLUS

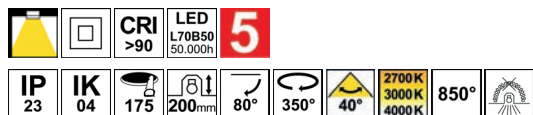

- Downlight encastré rond orientable 3 en 1.
- 2700K, 3000K ou 4000K au choix via un interrupteur sur le convertisseur.
- Verre de protection.
- Fixation par ressorts.
- Convertisseur non dimmable déporté fourni.
- Bague couvrant un diamètre de perçage de 220 à 240mm à commander séparément.

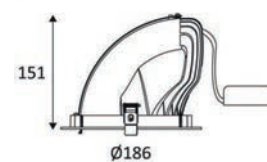

SPIRA 1 RX PLUS	MATIÈRE	LED	T°	LED Lumen	System Lumen	€
DO48805	■ NOIR	FONTE D'ALUMINIUM	40W	2700-3000-4000K	3400 Lm (4000K)	2478 Lm (4000K) 165,80 B
DO48804	■ BLANC	FONTE D'ALUMINIUM	40W	2700-3000-4000K	3400 Lm (4000K)	2478 Lm (4000K) 165,80 B

ACCESSOIRES	MATIÈRE	DESCRIPTION	€
DO54805	■ NOIR	ALUMINIUM BAGUE DE FINITION 250mm	21,30 A
DO54804	■ BLANC	ALUMINIUM BAGUE DE FINITION 250mm	21,30 A



NOIR



BLANC

## SPIRA 3 RX



- Downlight encastré rond orientable.
- Verre de protection.
- Fixation par ressorts.
- Convertisseur non dimmable déporté fourni.

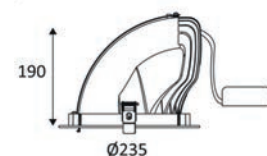

SPIRA 3 RX	MATIÈRE	LED	T°	LED Lumen	System Lumen	€
DO344NW04	■ BLANC	FONTE D'ALUMINIUM	60W	4000K	8680 Lm	7124 Lm 324,50 B



## FOCEA 1 SX PLUS

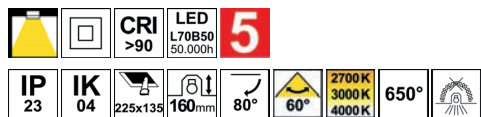

- Downlight encastré rectangulaire orientable 3 en 1.
- 2700K, 3000K ou 4000K au choix via un interrupteur sur le convertisseur.
- Verre de protection.
- Fixation par ressorts.
- Convertisseur non dimmable déporté fourni.

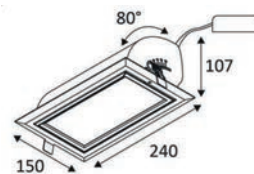

FOCEA 1 SX PLUS	MATIÈRE	LED	T°	LED Lumen	System Lumen	€
DO48905	NOIR	40W	2700-3000-4000K	3400 Lm (4000K)	2393 Lm (4000K)	192,60 B
DO48904	BLANC	40W	2700-3000-4000K	3400 Lm (4000K)	2393 Lm (4000K)	192,60 B



NOIR



BLANC

## FOCEA 2 SX

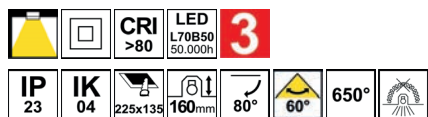

- Downlight encastré rectangulaire orientable.
- Verre de protection.
- Fixation par ressorts.
- Convertisseur non dimmable déporté fourni.

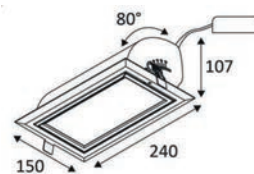

FOCEA 2 SX	MATIÈRE	LED	T°	LED Lumen	System Lumen	€
DO346NW04	BLANC	60W	4000K	8680 Lm	6338 Lm	310,00 B



# INDIGO

LIGHTING





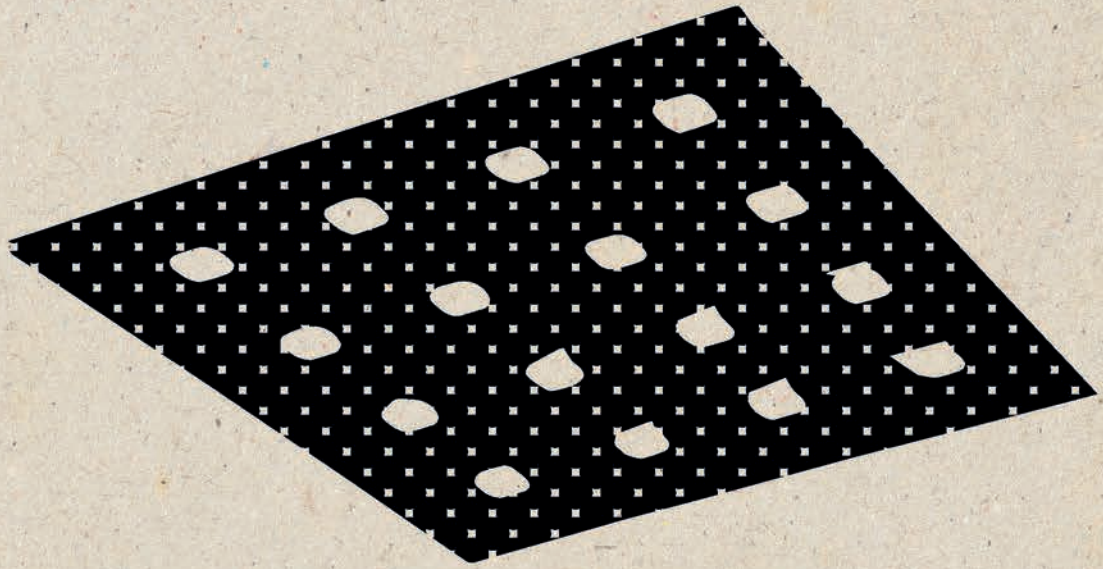

**DALLES LED**

## SOLIS 1

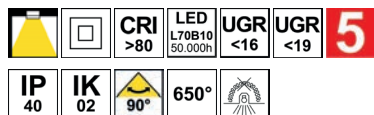
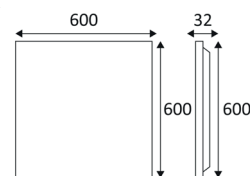

- Dalle LED 600x600mm.
- Diffuseur PS à structure prismatique.
- UGR<16 (P2A16) ou UGR<19 (P2A19).
- Connecteur rapide et filin de sécurité (1m) inclus.
- Convertisseur non dimmable déporté fourni ou convertisseur à commander séparément.
- Convertisseur dimmable DALI, Push-Dim et 0-10V en option.
- Kit de montage en saillie ou kit de suspension à commander séparément.
- Kit d'éclairage de secours en option.

SOLIS 1	MATIÈRE	LED	T°	LED Lumen	System Lumen	€
<b>CONVERTISSEUR INCLUS</b>						
P2A16S30WA <b>NEW</b>	BLANC	ALUMINIUM 30W	4000K	4125 Lm	3450 Lm	60,00 B
P2A19S40WA <b>NEW</b>	BLANC	ALUMINIUM 40W	4000K	5500 Lm	4600 Lm	70,00 B
<b>CONVERTISSEUR EXCLU</b>						
P2A16X30WA <b>NEW</b>	BLANC	ALUMINIUM 30W	4000K	4125 Lm	3450 Lm	55,00 B
P2A19X40WA <b>NEW</b>	BLANC	ALUMINIUM 40W	4000K	5500 Lm	4600 Lm	65,00 B

ACCESSOIRES	MATIÈRE	DESCRIPTION	L (mm)	€
PS6501100MA <b>NEW</b>		DRIVER 40W 650-1100mA CC DALI PUSH-DIM 0-10V	125	85,70 A
P2SMA <b>NEW</b>	BLANC	ALUMINIUM KIT DE MONTAGE EN SAILLIE	600	42,80 A
P1SK <b>NEW</b>	MÉTAL	KIT DE SUSPENSION		7,90 A
LEDEP10 <b>NEW</b>		KIT ECLAIRAGE DE SECOURS	200	233,10 A





## SOLIS 2

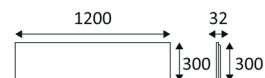
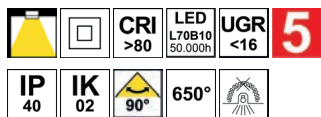

- Dalle LED 1200x300mm.
- Diffuseur PS à structure prismatique.
- Connecteur rapide et filin de sécurité (1m) inclus.
- Convertisseur non dimmable déporté fourni ou convertisseur à commander séparément.
- Convertisseur dimmable DALI, Push-Dim et 0-10V en option.
- Kit de montage en saillie ou kit de suspension à commander séparément.
- Kit d'éclairage de secours en option.



SOLIS 2	MATIÈRE	LED	T°	LED Lumen	System Lumen	€
<b>CONVERTISSEUR INCLUS</b>						
P2B16S30WA <b>NEW</b>	BLANC	ALUMINIUM	30W	4000K	4125 Lm	3450 Lm <b>95,50</b> B
<b>CONVERTISSEUR EXCLU</b>						
P2B16X30WA <b>NEW</b>	BLANC	ALUMINIUM	30W	4000K	4125 Lm	3450 Lm <b>80,00</b> B
ACCESSOIRES	MATIÈRE	DESCRIPTION	L (mm)			€
PS6501100MA <b>NEW</b>		DRIVER 40W 650-1100mA CC DALI PUSH-DIM 0-10V	125			<b>85,70</b> A
P2SMB <b>NEW</b>	BLANC	ALUMINIUM	KIT DE MONTAGE EN SAILLIE	1200		<b>51,40</b> A
P1SK <b>NEW</b>	MÉTAL		KIT DE SUSPENSION			<b>7,90</b> A
LEDEP10 <b>NEW</b>			KIT ECLAIRAGE DE SECOURS	200		<b>233,10</b> A

## SOLIS 3

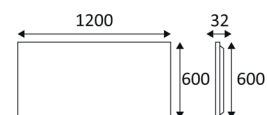
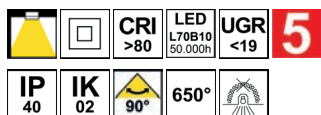

- Dalle LED 1200x600mm.
- Diffuseur PS à structure prismatique.
- Connecteur rapide et filin de sécurité (1m) inclus.
- Convertisseur non dimmable déporté fourni ou convertisseur à commander séparément.
- Convertisseur dimmable DALI / Push-Dim en option.
- Kit de montage en saillie ou kit de suspension à commander séparément.
- Kit d'éclairage de secours en option.



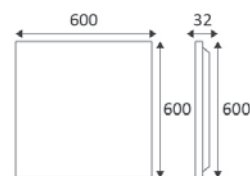

SOLIS 3	MATIÈRE	LED	T°	LED Lumen	System Lumen	€
<b>CONVERTISSEUR INCLUS</b>						
P2C19S60WA <b>NEW</b>	BLANC	ALUMINIUM	60W	4000K	8250 Lm	6600 Lm <b>152,50</b> B
<b>CONVERTISSEUR EXCLU</b>						
P2C19X60WA <b>NEW</b>	BLANC	ALUMINIUM	60W	4000K	8250 Lm	6600 Lm <b>122,70</b> B
ACCESSOIRES	MATIÈRE	DESCRIPTION	L (mm)			€
TR28000677 <b>NEW</b>		DRIVER 60W 900-1750mA CC DALI PUSH-DIM	220			<b>85,70</b> A
P2SMC <b>NEW</b>	BLANC	ALUMINIUM	KIT DE MONTAGE EN SAILLIE	1200		<b>61,20</b> A
P1SKC <b>NEW</b>			KIT DE SUSPENSION			<b>11,80</b> A
LEDEP10 <b>NEW</b>			KIT ECLAIRAGE DE SECOURS	200		<b>233,10</b> A

## SOLIS IP65



- Dalle LED 600x600mm.
- Diffuseur en polypropylène.
- Convertisseur non dimmable déporté fourni.
- Kit de montage en saillie à commander séparément.
- Kit d'éclairage de secours en option.

SOLIS IP65	MATIÈRE	LED	T°	LED Lumen	System Lumen	€
SOLIP66N4K <b>NEW</b> BLANC	ALUMINIUM	40W	4000K	5400 Lm	4500 Lm	124,00 A
ACCESSOIRES	MATIÈRE	DESCRIPTION	L (mm)	€		
P2SMA <b>NEW</b> BLANC	ALUMINIUM	KIT DE MONTAGE EN SAILLIE	600		42,80	A
LEDEP10 <b>NEW</b>		KIT ECLAIRAGE DE SECOURS	200		233,10	A

## SOLIS PRO

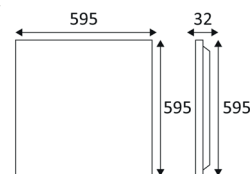
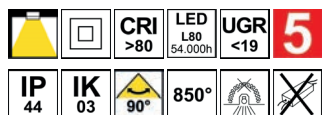

- Dalle LED 600x600mm.
- Diffuseur PS à structure prismatique.
- Connecteur rapide et filin de sécurité inclus.
- Convertisseur dimmable DALI, Push-Dim et 0-10V à commander séparément.
- Kit de montage en saillie à commander séparément.
- Kit d'éclairage de secours en option.

SOLIS PRO	MATIÈRE	LED	T°	LED Lumen	System Lumen	€
SOLP66X4K <b>NEW</b> BLANC	ALUMINIUM	28W	4000K	5400 Lm	4480 Lm	113,30 A
ACCESSOIRES	MATIÈRE	DESCRIPTION	L (mm)	€		
PS6501100MA <b>NEW</b>		DRIVER 40W 650-1100mA CC DALI PUSH-DIM 0-10V	125		85,70	A
P2SMA <b>NEW</b> BLANC	ALUMINIUM	KIT DE MONTAGE EN SAILLIE	600		42,80	A
LEDEP10 <b>NEW</b>		KIT ECLAIRAGE DE SECOURS	200		233,10	A



## SOLIS PRO CSP

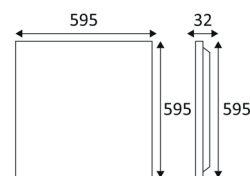

NEW

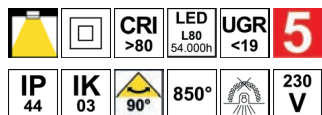

- Dalle LED 600x600mm.
- Diffuseur PS à structure prismatique.
- Connecteur rapide et filin de sécurité inclus.
- Convertisseur non dimmable déporté fourni.
- Multi-puissance : 22, 24, 26 ou 28W au choix via un interrupteur sur le convertisseur.
- Kit de montage en saillie à commander séparément.
- Kit d'éclairage de secours en option.

SOLIS PRO CSP	MATIÈRE	LED	T°	System Lumen	€
SOLP66N4K <b>NEW</b> BLANC	ALUMINIUM	22W 24W 26W 28W	4000K	3520 Lm 3840 Lm 4160 Lm 4480 Lm	123,60 A

ACCESSOIRES	MATIÈRE	DESCRIPTION	L (mm)	€
P2SMA <b>NEW</b> BLANC	ALUMINIUM	KIT DE MONTAGE EN SAILLIE	600 	42,80 A
LEDEP10 <b>NEW</b>		KIT ECLAIRAGE DE SECOURS	200 	233,10 A



## DOMINO

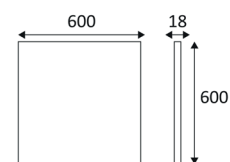
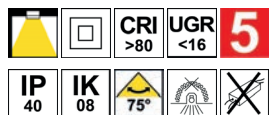

- Dalle LED 600x600mm.
- Lentilles en polycarbonate.
- Connecteur rapide et filin de sécurité inclus.
- Convertisseur dimmable DALI, Push-Dim et 0-10V à commander séparément.
- Kit d'éclairage de secours en option.

DOMINO		MATIÈRE	LED	T°	System Lumen	€
DMB66X4K	<b>NEW</b>	NOIR	ACIER	27W	4000K	4350 Lm 144,20 A
DMW66X4K	<b>NEW</b>	BLANC	ACIER	27W	4000K	4350 Lm 144,20 A

ACCESSOIRES	DESCRIPTION	L (mm)	€
PS6501100MA	<b>NEW</b> DRIVER 40W 650-1100mA CC DALI PUSH-DIM 0-10V	125	85,70 A
LEDEP10	<b>NEW</b> KIT ECLAIRAGE DE SECOURS	200	233,10 A



NOIR

BLANC

## DOMINO CSP

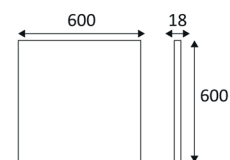
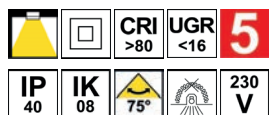

- Dalle LED 600x600mm.
- Lentilles en polycarbonate.
- Connecteur rapide et filin de sécurité inclus.
- Convertisseur non dimmable déporté fourni.
- Multi-puissance : 22, 24, 25 ou 27W au choix via un interrupteur sur le convertisseur.
- Kit d'éclairage de secours en option.

DOMINO CSP		MATIÈRE	LED	T°	System Lumen	€
DMB66N4K	<b>NEW</b>	NOIR	ACIER	22W 24W 25W 27W	4000K	3550 Lm 3850 Lm 4100 Lm 4350 Lm 154,50 A
DMW66N4K	<b>NEW</b>	BLANC	ACIER	22W 24W 25W 27W	4000K	3550 Lm 3850 Lm 4100 Lm 4350 Lm 154,50 A

ACCESSOIRES	DESCRIPTION	L (mm)	€
LEDEP10	<b>NEW</b> KIT ECLAIRAGE DE SECOURS	200	233,10 A



NOIR

BLANC



# INDIGO

LIGHTING





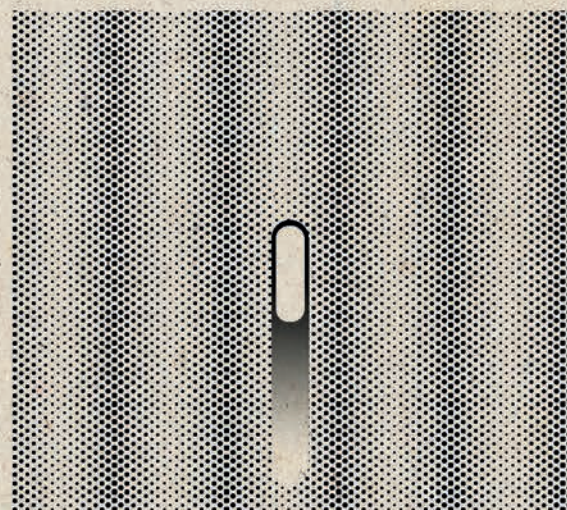

## **ENCASTRÉS MURAUX**

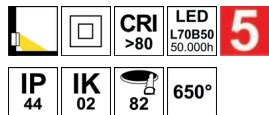
**KO 703R**

- Encastré mural décoratif rond pour l'éclairage de circulations.
- Verre de protection.
- Boîtier d'encastrement inclus.
- Convertisseur non dimmable intégré dans l'appareil.

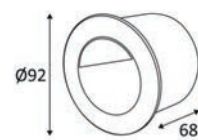

KO 703R	MATIÈRE	LED	T°	LED Lumen	System Lumen	€
KO703R	ALUMINIUM	1W	3000K	120 Lm	56 Lm	85,50 B

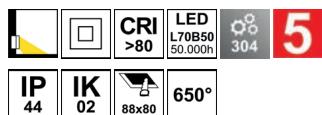
**KO 703S**

- Encastré mural décoratif carré pour l'éclairage de circulations.
- Verre de protection.
- Boîtier d'encastrement inclus.
- Convertisseur non dimmable intégré dans l'appareil.

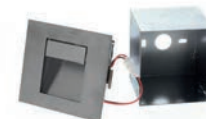
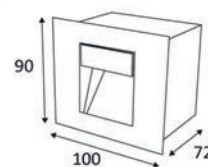

KO 703S	MATIÈRE	LED	T°	LED Lumen	System Lumen	€
KO703S	INOX304	1W	3000K	120 Lm	56 Lm	89,60 B

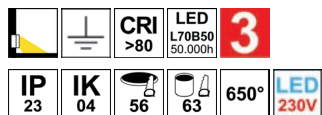

**EVA 65R**

- Encastré mural décoratif rond pour l'éclairage de circulations.
- Fixation par lamelles.
- Boîtier d'encastrement inclus.
- Ne nécessite pas de convertisseur.
- Non dimmable.

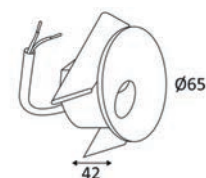

EVA 65R	MATIÈRE	LED	T°	LED Lumen	System Lumen	€	
DW110R31	BLANC	ALUMINIUM	4W	3000K	420 Lm	180 Lm	98,90 B

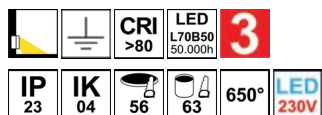
**EVA 65S**

- Encastré mural décoratif carré pour l'éclairage de circulations.
- Fixation par lamelles.
- Boîtier d'encastrement inclus.
- Ne nécessite pas de convertisseur.
- Non dimmable.

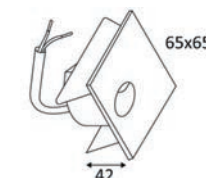

EVA 65S	MATIÈRE	LED	T°	LED Lumen	System Lumen	€	
DW110S31	BLANC	ALUMINIUM	4W	3000K	420 Lm	205 Lm	98,90 B



## LIKA

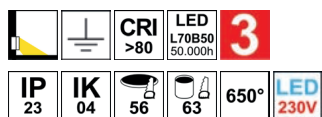

- Encastré mural décoratif carré pour l'éclairage de circulations.
- Fixation par lamelles.
- Boîtier d'encastrement inclus.
- Ne nécessite pas de convertisseur.
- Non dimmable.

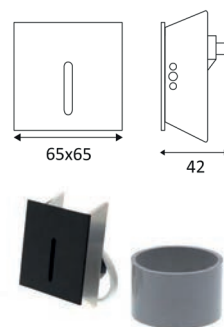

LIKA		MATIÈRE	LED	T°	LED Lumen	System Lumen	€
WA173WW05	 NOIR MAT	ALUMINIUM	4W	3000K	420 Lm	80 Lm	98,90 B
WA173WW30	 BLANC MAT	ALUMINIUM	4W	3000K	420 Lm	80 Lm	98,90 B



NOIR MAT

BLANC MAT

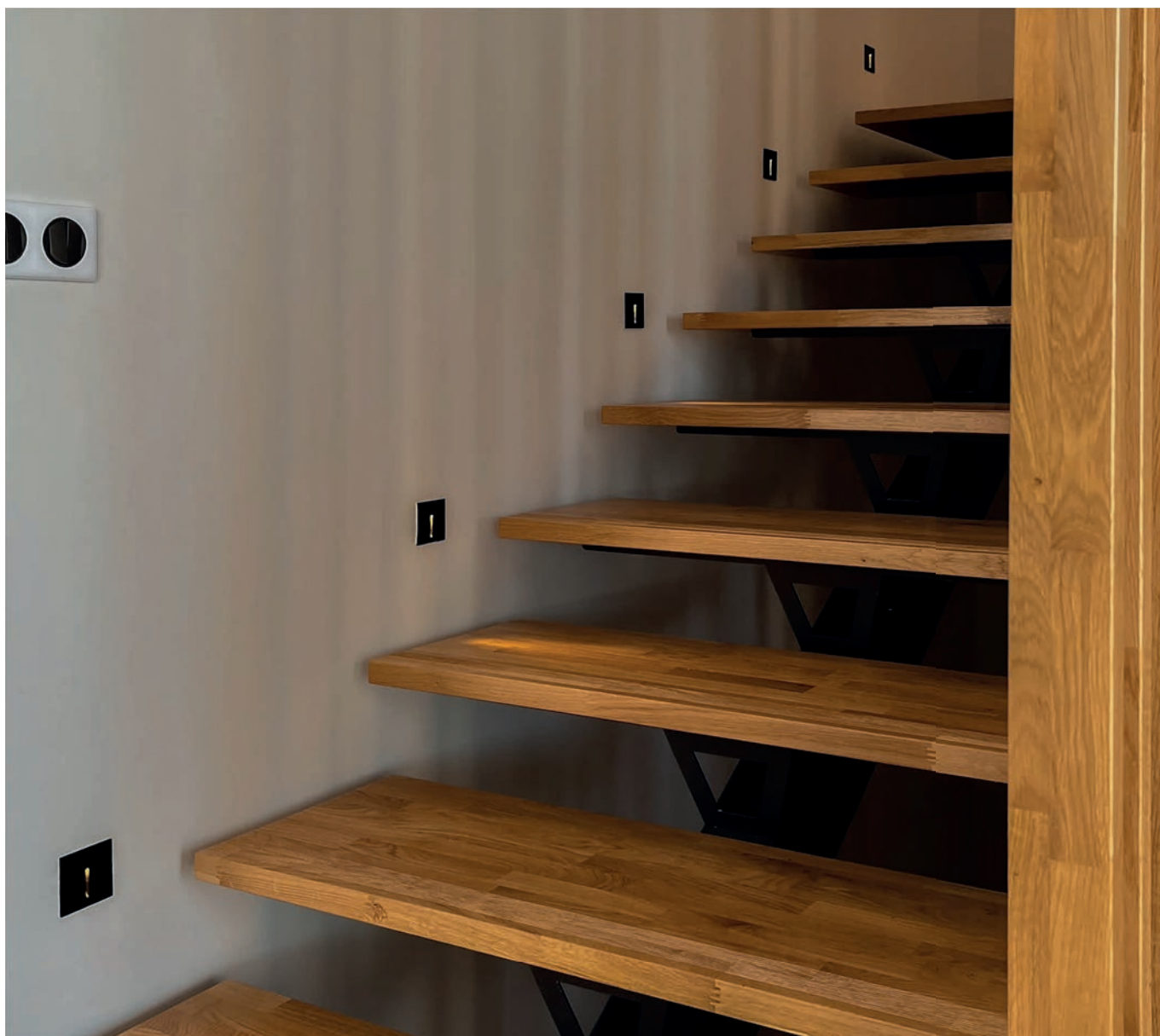



## MAKA

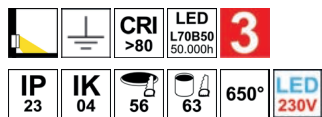

- Encastré mural décoratif carré pour l'éclairage de circulations.
- Fixation par lamelles.
- Boîtier d'encastrement inclus.
- Ne nécessite pas de convertisseur.
- Non dimmable.

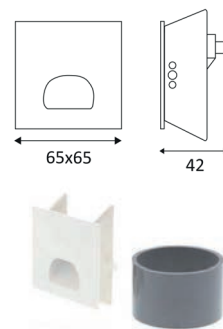
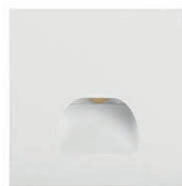

MAKA		MATIÈRE	LED	T°	LED Lumen	System Lumen	€
WA174WW05	■ NOIR MAT	ALUMINIUM	4W	3000K	420 Lm	210 Lm	98,90 B
WA174WW30	■ BLANC MAT	ALUMINIUM	4W	3000K	420 Lm	210 Lm	98,90 B



NOIR MAT

BLANC MAT



# INDIGO

LIGHTING





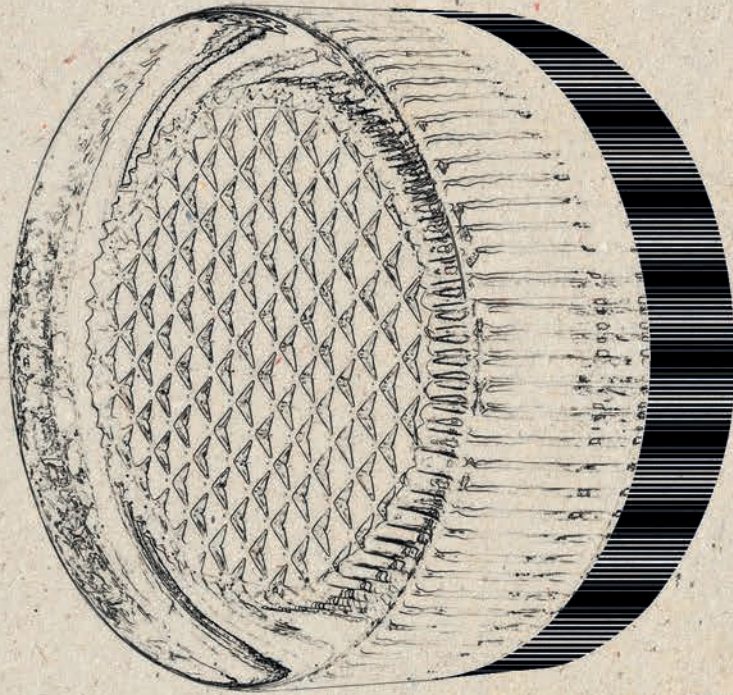

## APPLIQUES

NEW

## EVIA G9

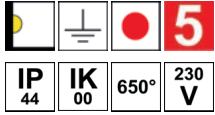

- Applique murale décorative.
- Diffuseur en verre opalin.
- Lampe LED G9 8W 3000K incluse.

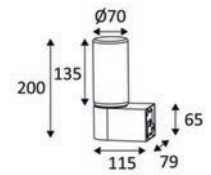

EVIA G9			MATIÈRE	SOCKET	Watt Max	T°	LED Lumen	System Lumen	€
WA25404	NEW	BLANC	ACIER	G9	8W	3000K	900 Lm	570 Lm	108,60 A
WA25403	NEW	CHROME	ACIER	G9	8W	3000K	900 Lm	570 Lm	117,10 A
WA25445	NEW	NICKEL MAT	ACIER	G9	8W	3000K	900 Lm	570 Lm	117,10 A
WA25461	NEW	LAITON BROSSÉ	ACIER INOXYDABLE	G9	8W	3000K	900 Lm	570 Lm	145,70 A



BLANC



CHROME



NICKEL MAT



LAITON BROSSÉ





## VITEL GX53

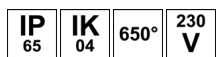

- Applique murale ou plafonnier décoratif.
- Diffuseur en verre pyramidal clair.
- Lampe LED GX53 9W 3000K incluse.

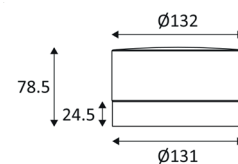

NEW

VITEL GX53			MATIÈRE	SOCKET	Watt Max	T°	LED Lumen	System Lumen	€
WA25330	NEW	BLANC MAT	POLYCARBONATE	GX53	9W	3000K	800 Lm	450 Lm	149,70 A
WA25303	NEW	CHROME	POLYCARBONATE	GX53	9W	3000K	800 Lm	450 Lm	151,40 A
WA25345	NEW	NICKEL MAT	POLYCARBONATE	GX53	9W	3000K	800 Lm	450 Lm	154,30 A
WA25361	NEW	LAITON BROSSÉ	POLYCARBONATE	GX53	9W	3000K	800 Lm	450 Lm	161,70 A



BLANC MAT



CHROME



NICKEL MAT



LAITON BROSSÉ



## OKTO 2 GU10

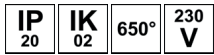

- Applique murale décorative.
- Eclairage "up&down".

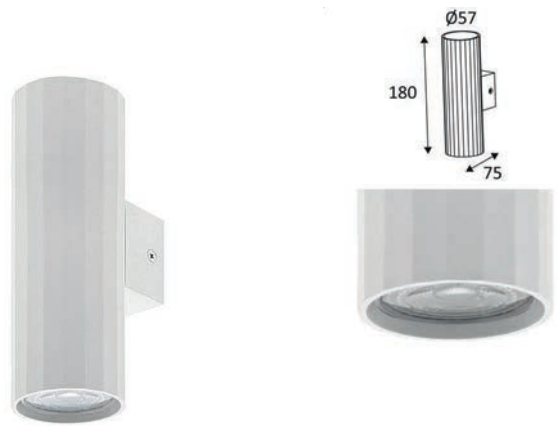

OKTO 2 GU10		MATIÈRE	SOCKET	LAMP	Watt Max	€
WA23405	■ NOIR MAT	ALUMINIUM	GU10	PAR16 LED	2x10W	51,50 B
WA23408	■ NOIR MAT - CHAMPAGNE	ALUMINIUM	GU10	PAR16 LED	2x10W	53,60 B
WA23406	■ NOIR MAT - OR ROSE	ALUMINIUM	GU10	PAR16 LED	2x10W	53,60 B
WA23483	■ NOIR MAT - ROSE	ALUMINIUM	GU10	PAR16 LED	2x10W	53,60 B
WA23430	■ BLANC MAT	ALUMINIUM	GU10	PAR16 LED	2x10W	51,50 B

### OKTO GU10

DANS LA MÊME GAMME  
PAGE 198

### OKTO P GU10

DANS LA MÊME GAMME  
PAGE 240



NOIR MAT



NOIR MAT -  
CHAMPAGNE



NOIR MAT - OR  
ROSE



NOIR MAT - ROSE



BLANC MAT





## SNOOP GU10

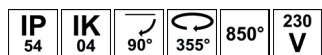

- Applique murale décorative pour éclairage intérieur et extérieur.
- Cache de finition magnétique adaptable en hauteur afin de modifier la luminance.
- Avec entrée et sortie de câble.

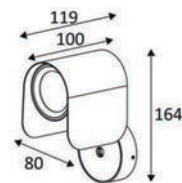

SNOOP GU10		MATIÈRE	SOCKET	LAMP	Watt Max	€
WA26105		NOIR MAT	ALUMINIUM	GU10	PAR16 LED	10W 79,30 B
WA26135		NOIR MAT - BLANC MAT	ALUMINIUM	GU10	PAR16 LED	10W 79,30 B
WA26108		NOIR MAT - CHAMPAGNE	ALUMINIUM	GU10	PAR16 LED	10W 93,70 B
WA26183		NOIR MAT - ROSE	ALUMINIUM	GU10	PAR16 LED	10W 93,70 B



NOIR MAT



NOIR MAT - BLANC MAT



NOIR MAT - CHAMPAGNE



NOIR MAT - ROSE

## SNOOP

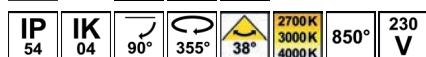
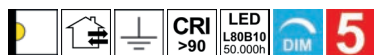

- Applique murale décorative pour éclairage intérieur et extérieur.
- Cache de finition magnétique adaptable en hauteur afin de modifier la luminance.
- 2700K, 3000K ou 4000K au choix via un interrupteur à l'arrière du luminaire.
- Avec entrée et sortie de câble.
- Convertisseur dimmable intégré dans l'appareil.
- Compatible avec variateur fin de phase.

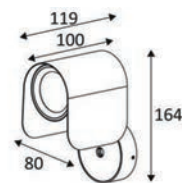

SNOOP		MATIÈRE	LED	T°	LED Lumen	System Lumen	€
WA26205		NOIR MAT	ALUMINIUM	10W	2700-3000-4000K	1050 Lm (4000K)	865 Lm (4000K) 128,80 B
WA26235		NOIR MAT - BLANC MAT	ALUMINIUM	10W	2700-3000-4000K	1050 Lm (4000K)	865 Lm (4000K) 128,80 B
WA26208		NOIR MAT - CHAMPAGNE	ALUMINIUM	10W	2700-3000-4000K	1050 Lm (4000K)	865 Lm (4000K) 148,30 B
WA26283		NOIR MAT - ROSE	ALUMINIUM	10W	2700-3000-4000K	1050 Lm (4000K)	865 Lm (4000K) 148,30 B



NOIR MAT



NOIR MAT - BLANC MAT



NOIR MAT - CHAMPAGNE



NOIR MAT - ROSE



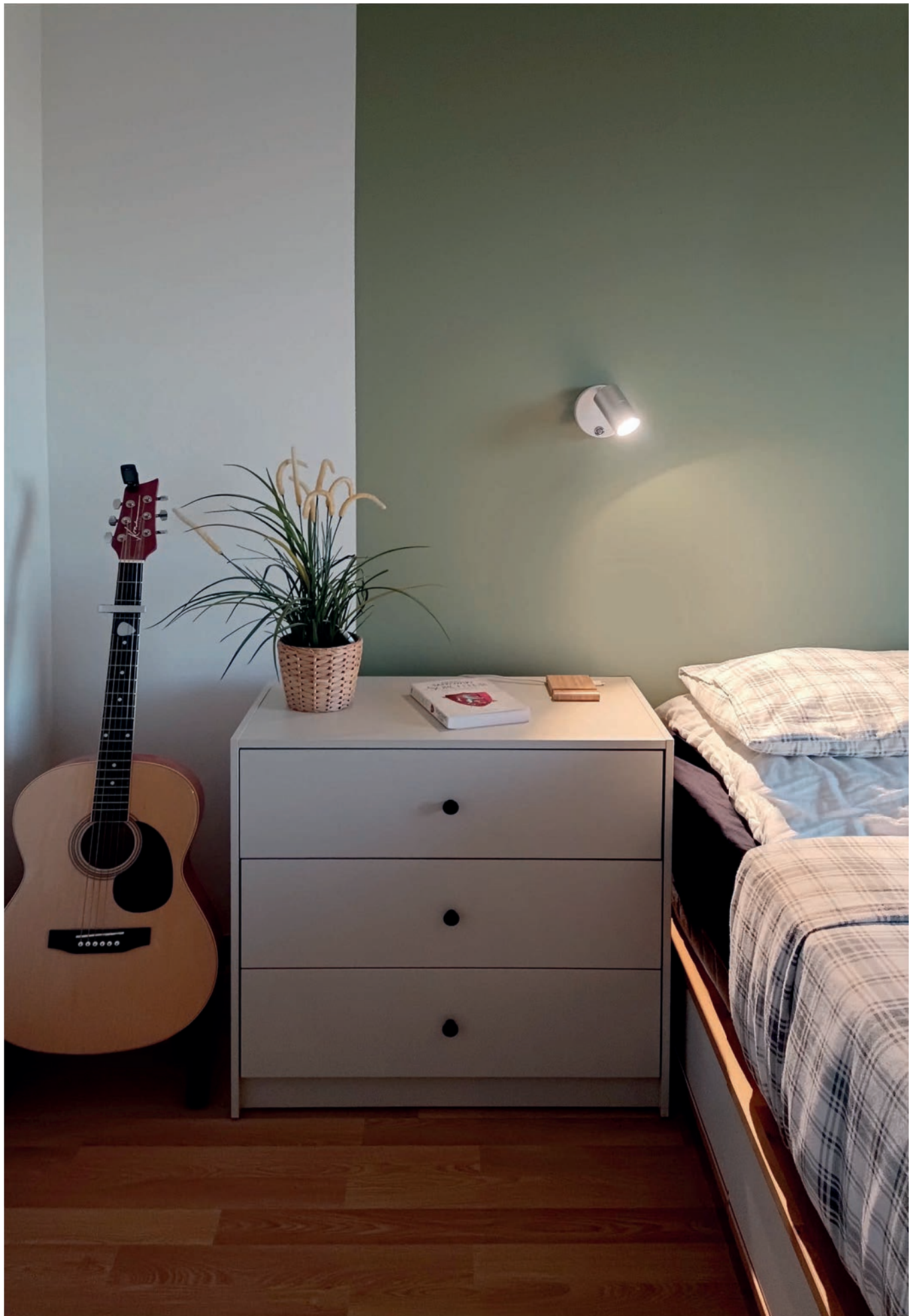





## AUREA 1 W

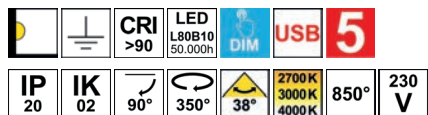

- Applique murale décorative.
- Base apparente avec interrupteur variateur et prise USB (5VDC, 2,4A).
- 2700K, 3000K ou 4000K au choix via un interrupteur à l'arrière du luminaire.
- Convertisseur dimmable intégré dans l'appareil.

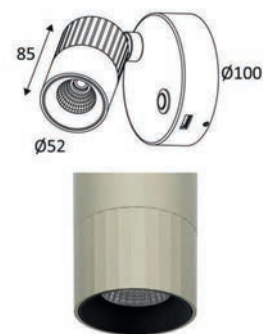

AUREA 1 W	MATIERE	LED	T°	LED Lumen	System Lumen	€	
WA25805	NOIR MAT	ALUMINIUM	7W	2700-3000-4000K	625 Lm (4000K)	500 Lm (4000K)	115,40 B
WA25808	NOIR MAT - CHAMPAGNE	ALUMINIUM	7W	2700-3000-4000K	625 Lm (4000K)	500 Lm (4000K)	129,80 B
WA25883	NOIR MAT - ROSE	ALUMINIUM	7W	2700-3000-4000K	625 Lm (4000K)	500 Lm (4000K)	129,80 B
WA25830	BLANC MAT	ALUMINIUM	7W	2700-3000-4000K	625 Lm (4000K)	500 Lm (4000K)	115,40 B
WA25849	BLANC MAT - CHAMPAGNE	ALUMINIUM	7W	2700-3000-4000K	625 Lm (4000K)	500 Lm (4000K)	129,80 B
WA25882	BLANC MAT - ROSE	ALUMINIUM	7W	2700-3000-4000K	625 Lm (4000K)	500 Lm (4000K)	129,80 B



NOIR MAT



NOIR MAT - CHAMPAGNE



NOIR MAT - ROSE



BLANC MAT



BLANC MAT - CHAMPAGNE



BLANC MAT - ROSE

## AUREA 2 W

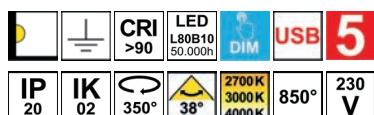

- Applique murale décorative.
- Base apparente avec interrupteur variateur et prise USB (5VDC, 2,4A).
- Longueur du flexible 250mm.
- 2700K, 3000K ou 4000K au choix via un interrupteur à l'arrière du luminaire.
- Convertisseur dimmable intégré dans l'appareil.

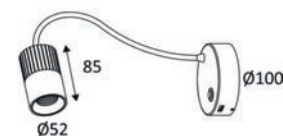

AUREA 2 W	MATIERE	LED	T°	LED Lumen	System Lumen	€	
WA25905	NOIR MAT	ALUMINIUM	7W	2700-3000-4000K	625 Lm (4000K)	500 Lm (4000K)	117,40 B
WA25908	NOIR MAT - CHAMPAGNE	ALUMINIUM	7W	2700-3000-4000K	625 Lm (4000K)	500 Lm (4000K)	129,80 B
WA25983	NOIR MAT - ROSE	ALUMINIUM	7W	2700-3000-4000K	625 Lm (4000K)	500 Lm (4000K)	129,80 B
WA25930	BLANC MAT	ALUMINIUM	7W	2700-3000-4000K	625 Lm (4000K)	500 Lm (4000K)	117,40 B
WA25949	BLANC MAT - CHAMPAGNE	ALUMINIUM	7W	2700-3000-4000K	625 Lm (4000K)	500 Lm (4000K)	129,80 B
WA25982	BLANC MAT - ROSE	ALUMINIUM	7W	2700-3000-4000K	625 Lm (4000K)	500 Lm (4000K)	129,80 B



NOIR MAT



NOIR MAT - CHAMPAGNE



NOIR MAT - ROSE



BLANC MAT



BLANC MAT - CHAMPAGNE



BLANC MAT - ROSE

## AUREA 3 W

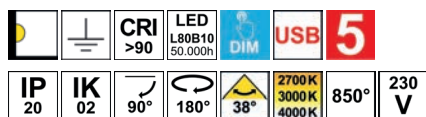

- Applique murale décorative.
- Base apparente avec interrupteur variateur et prise USB (5VDC, 2,4A).
- 2700K, 3000K ou 4000K au choix via un interrupteur à l'arrière du luminaire.
- Convertisseur dimmable intégré dans l'appareil.



AUREA 3 W	MATÉRIE	LED	T°	LED Lumen	System Lumen	€	
WA26005	NOIR MAT	ALUMINIUM	7W	2700-3000-4000K	625 Lm (4000K)	500 Lm (4000K)	133,90 B
WA26008	NOIR MAT - CHAMPAGNE	ALUMINIUM	7W	2700-3000-4000K	625 Lm (4000K)	500 Lm (4000K)	152,40 B
WA26083	NOIR MAT - ROSE	ALUMINIUM	7W	2700-3000-4000K	625 Lm (4000K)	500 Lm (4000K)	152,40 B
WA26030	BLANC MAT	ALUMINIUM	7W	2700-3000-4000K	625 Lm (4000K)	500 Lm (4000K)	133,90 B
WA26049	BLANC MAT - CHAMPAGNE	ALUMINIUM	7W	2700-3000-4000K	625 Lm (4000K)	500 Lm (4000K)	152,40 B
WA26082	BLANC MAT - ROSE	ALUMINIUM	7W	2700-3000-4000K	625 Lm (4000K)	500 Lm (4000K)	152,40 B



NOIR MAT



NOIR MAT - CHAMPAGNE



NOIR MAT - ROSE



BLANC MAT



BLANC MAT - CHAMPAGNE



BLANC MAT - ROSE

## AUREA 4 W

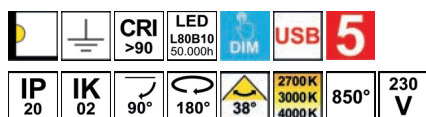

- Applique murale décorative.
- Base apparente avec interrupteur variateur, prise USB (5VDC, 2,4A) et chargeur sans-fil (pour smartphones compatibles).
- La charge par induction nécessite que le smartphone soit mis en contact direct avec la surface de recharge, sans protection ou coque.
- 2700K, 3000K ou 4000K au choix via un interrupteur à l'arrière du luminaire.
- Convertisseur dimmable intégré dans l'appareil.

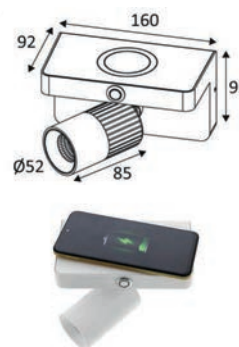

AUREA 4 W	MATÉRIE	LED	T°	LED Lumen	System Lumen	€	
WA26305	NOIR MAT	ALUMINIUM	7W	2700-3000-4000K	625 Lm (4000K)	500 Lm (4000K)	137,00 B
WA26308	NOIR MAT - CHAMPAGNE	ALUMINIUM	7W	2700-3000-4000K	625 Lm (4000K)	500 Lm (4000K)	150,40 B
WA26383	NOIR MAT - ROSE	ALUMINIUM	7W	2700-3000-4000K	625 Lm (4000K)	500 Lm (4000K)	150,40 B
WA26330	BLANC MAT	ALUMINIUM	7W	2700-3000-4000K	625 Lm (4000K)	500 Lm (4000K)	137,00 B
WA26349	BLANC MAT - CHAMPAGNE	ALUMINIUM	7W	2700-3000-4000K	625 Lm (4000K)	500 Lm (4000K)	150,40 B
WA26382	BLANC MAT - ROSE	ALUMINIUM	7W	2700-3000-4000K	625 Lm (4000K)	500 Lm (4000K)	150,40 B



NOIR MAT



NOIR MAT - CHAMPAGNE



NOIR MAT - ROSE



BLANC MAT



BLANC MAT - CHAMPAGNE



BLANC MAT - ROSE



## MILO 1

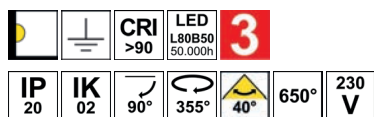

- Applique murale décorative.
- Base apparente avec interrupteur.
- Convertisseur non dimmable intégré dans l'appareil.

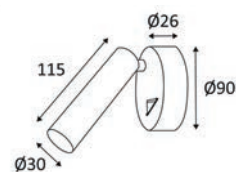

MILO 1		MATIÈRE	LED	T°	LED Lumen	System Lumen	€
WA11205	■ NOIR MAT	ALUMINIUM	5W	3000K	500 Lm	405 Lm	150,40 B
WA11230	■ BLANC MAT	ALUMINIUM	5W	3000K	500 Lm	450 Lm	150,40 B
WA11263	■ LAITON BROSSE	ALUMINIUM	5W	3000K	500 Lm	405 Lm	157,60 B



NOIR MAT



BLANC MAT



LAITON BROSSE

## MILO 2

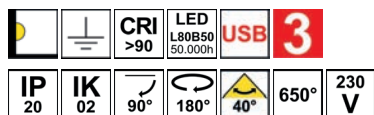

- Applique murale décorative.
- Base apparente avec interrupteur permettant trois niveaux d'éclairage (25%, 50% et 100%) et deux prises USB (5VDC, 2A).
- Convertisseur non dimmable intégré dans l'appareil.



MILO 2		MATIÈRE	LED	T°	LED Lumen	System Lumen	€
WA165WW05	■ NOIR MAT	ALUMINIUM	5W	3000K	500 Lm	405 Lm	202,90 B
WA165WW30	■ BLANC MAT	ALUMINIUM	5W	3000K	500 Lm	450 Lm	202,90 B



NOIR MAT



BLANC MAT







## MILO 3

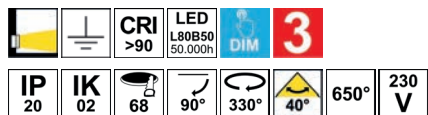

- Applique murale décorative.
- Base semi-encastrée.
- Avec interrupteur variateur.
- Livrée avec convertisseur dimmable.
- Montage dans un boîtier d'encastrement standard (non fourni).

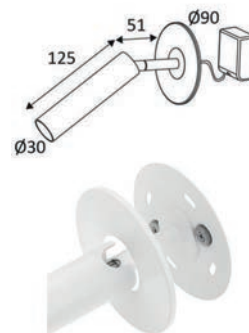

MILO 3		MATIÈRE	LED	T°	LED Lumen	System Lumen	€	
WA215SW05		NOIR MAT	ALUMINIUM	5W	2700K	460 Lm	395 Lm	125,70 B
WA215SW30		BLANC MAT	ALUMINIUM	5W	2700K	460 Lm	395 Lm	125,70 B
WA215SW63		LAITON BROSSE	ALUMINIUM	5W	2700K	460 Lm	395 Lm	131,80 B



NOIR MAT



BLANC MAT



LAITON BROSSE

## MILO 4

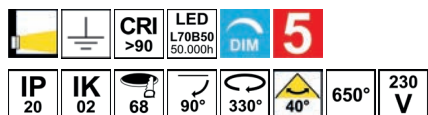

- Applique murale décorative.
- Base semi-encastrée.
- Convertisseur dimmable déporté fourni.
- Compatible avec variateur début et fin de phase.
- Montage dans un boîtier d'encastrement standard (non fourni).

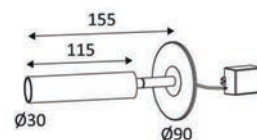

MILO 4		MATIÈRE	LED	T°	LED Lumen	System Lumen	€	
WA235SW05		NOIR MAT	ALUMINIUM	5W	2700K	465 Lm	445 Lm	133,90 B
WA235SW30		BLANC MAT	ALUMINIUM	5W	2700K	465 Lm	445 Lm	133,90 B
WA235SW63		LAITON BROSSE	ALUMINIUM	5W	2700K	465 Lm	445 Lm	147,30 B



NOIR MAT



BLANC MAT



LAITON BROSSE

## BETSY 1

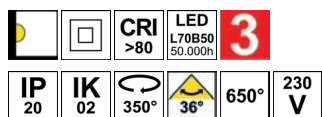

- Applique murale décorative.
- Base apparente avec interrupteur.
- Longueur du flexible 280mm.
- Convertisseur non dimmable intégré dans l'appareil.



BETSY 1		MATIÈRE	LED	T°	LED Lumen	System Lumen	€
WA153WW05	■ NOIR	ALUMINIUM	3W	3000K	250 Lm	150 Lm	72,10 B
WA153WW30	■ BLANC	ALUMINIUM	3W	3000K	250 Lm	150 Lm	72,10 B



NOIR



BLANC







## BETSY 2

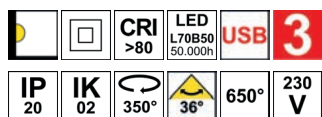

- Applique murale décorative.
- Base apparente avec interrupteur et prise USB (5VDC, 1A).
- Longueur du flexible 280mm.
- Convertisseur non dimmable intégré dans l'appareil.

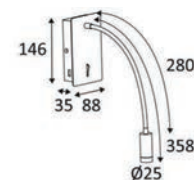

BETSY 2		MATIÈRE	LED	T°	LED Lumen	System Lumen	€
WA154WW05	■ NOIR	ALUMINIUM	3W	3000K	250 Lm	150 Lm	144,20 B
WA154WW30	■ BLANC	ALUMINIUM	3W	3000K	250 Lm	150 Lm	144,20 B



NOIR



BLANC



## KAVA

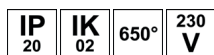

- Applique murale décorative.
- Eclairage "up&down".
- Convertisseur dimmable intégré dans l'appareil.

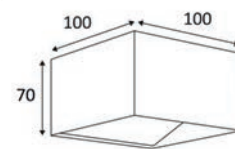

KAVA	MATIERE	LED	T°	LED Lumen	System Lumen	€
KU147916	BLANC MAT ALUMINIUM	5W	3000K	500 Lm	485 Lm	179,20 B
WA209WW18	NOIR MAT - DORE ALUMINIUM	5W	3000K	500 Lm	280 Lm	158,60 B
WA209WW80	BLANC MAT - DORE ALUMINIUM	5W	3000K	500 Lm	340 Lm	158,60 B



BLANC MAT

NOIR MAT - DORE

BLANC MAT - DORE

## FULLA

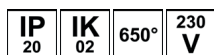

- Applique murale décorative.
- Eclairage "up&down".
- Convertisseur dimmable intégré dans l'appareil.
- Compatible avec variateur début et fin de phase.

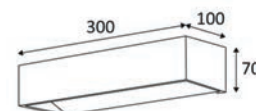

FULLA	MATIERE	LED	T°	LED Lumen	System Lumen	€
WA169WW30	BLANC MAT ALUMINIUM	2x7,5W	3000K	1900 Lm	1428 Lm	229,70 B



## GLAM 164

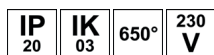
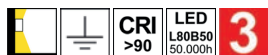

- Applique murale décorative.
- Eclairage "up&down".
- Convertisseur non dimmable intégré dans l'appareil.

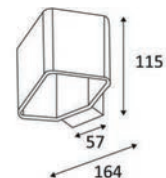

GLAM 164		MATIÈRE	LED	T°	LED Lumen	System Lumen	€
WA11130	BLANC MAT	ALUMINIUM	7,5W	3000K	550 Lm	347 Lm	173,00 B
WA11141	ALUMINIUM POLI	ALUMINIUM	7,5W	3000K	550 Lm	347 Lm	179,20 B



BLANC MAT



ALUMINIUM POLI

## ELLA

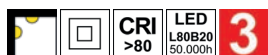

- Applique murale décorative.
- Diffuseur en verre opalin.
- Convertisseur non dimmable intégré dans l'appareil.

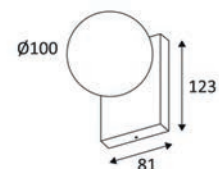
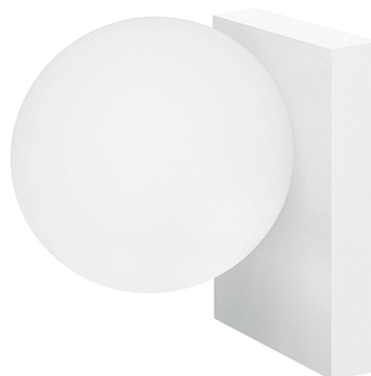

ELLA		MATIÈRE	LED	T°	LED Lumen	System Lumen	€
WA252WW05	NOIR MAT	ALUMINIUM	4W	3000K	375 Lm	245 Lm	152,40 B
WA252WW30	BLANC MAT	ALUMINIUM	4W	3000K	375 Lm	245 Lm	152,40 B
WA252WW10	CHAMPAGNE	ALUMINIUM	4W	3000K	375 Lm	245 Lm	173,00 B



NOIR MAT



BLANC MAT



CHAMPAGNE



## GLAM 265

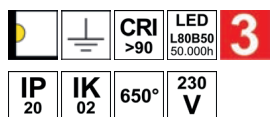

- Applique murale décorative.
- Convertisseur non dimmable intégré dans l'appareil.

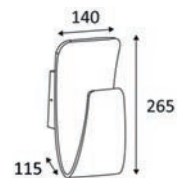

GLAM 265	MATIÈRE	LED	T°	LED Lumen	System Lumen	€	
WA11018	NOIR MAT - DORE	ALUMINIUM	7,5W	3000K	900 Lm	385 Lm	214,20 B

## GLAM 90

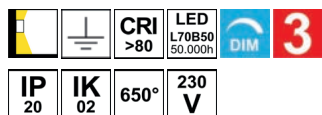

- Applique murale décorative.
- Eclairage "up&down".
- Convertisseur dimmable intégré dans l'appareil.
- Compatible avec variateur début et fin de phase.

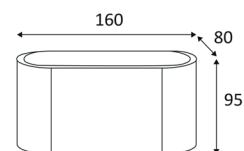

GLAM 90	MATIÈRE	LED	T°	LED Lumen	System Lumen	€	
WA175WW17	NOIR MAT - ARGENT	ALUMINIUM	10W	3000K	1010 Lm	680 Lm	162,70 B
WA175WW18	NOIR MAT - DORE	ALUMINIUM	10W	3000K	1010 Lm	450 Lm	162,70 B



NOIR MAT - ARGENT NOIR MAT - DORE



## GLAM 250

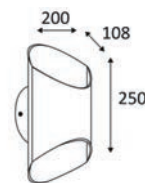
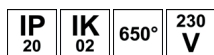

- Applique murale décorative.
- Eclairage "up&down".
- Convertisseur dimmable intégré dans l'appareil.
- Compatible avec variateur début et fin de phase.

GLAM 250		MATIÈRE	LED	T°	LED Lumen	System Lumen	€	
WA176WW17		NOIR MAT - ARGENT	ALUMINIUM	12W	3000K	1010 Lm	520 Lm	197,80 B
WA176WW18		NOIR MAT - DORE	ALUMINIUM	12W	3000K	1010 Lm	360 Lm	197,80 B



NOIR MAT - ARGENT NOIR MAT - DORE







## HEDI

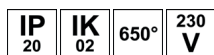

- Applique murale décorative.
- Eclairage "up&down".
- Température de couleur variable de 2000K à 3000K suivant l'intensité de dimming.
- Convertisseur dimmable intégré dans l'appareil.
- Compatible avec variateur début et fin de phase.

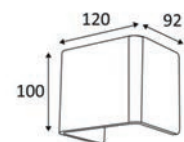

HEDI	MATIERE	LED	T°	LED Lumen	System Lumen	€	
WA17030	BLANC MAT	ALUMINIUM	6W	2000-3000K	620 Lm (3000K)	412 Lm (3000K)	171,00 B
WA17041	ALUMINIUM POLI	ALUMINIUM	6W	2000-3000K	620 Lm (3000K)	412 Lm (3000K)	182,30 B
WA17070	MARBRE	ALUMINIUM	6W	2000-3000K	620 Lm (3000K)	412 Lm (3000K)	188,50 B



BLANC MAT



ALUMINIUM POLI



MARBRE

## BIXBY

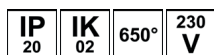
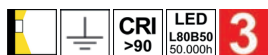

- Applique murale décorative.
- Eclairage "up&down".
- Convertisseur non dimmable intégré dans l'appareil.

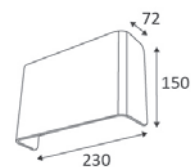

BIXBY	MATIERE	LED	T°	LED Lumen	System Lumen	€	
WA12840	BOIS GRIS	BOIS	12W	3000K	1250 Lm	755 Lm	202,90 B
WA12842	BOIS CLAIR	BOIS	12W	3000K	1250 Lm	755 Lm	202,90 B
WA12830	BLANC MAT	ALUMINIUM	12W	3000K	1250 Lm	755 Lm	202,90 B
WA12841	ALUMINIUM POLI	ALUMINIUM	12W	3000K	1250 Lm	755 Lm	202,90 B

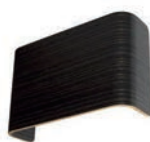

BOIS GRIS



BOIS CLAIR



BLANC MAT



ALUMINIUM POLI



## FOLD 1

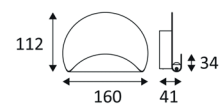
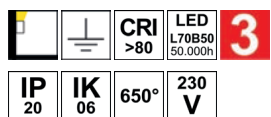

- Applique murale décorative.
- Eclairage indirect.
- Convertisseur non dimmable intégré dans l'appareil.

FOLD 1	MATÉRIE	LED	T°	LED Lumen	System Lumen	€	
WA236WW30	BLANC MAT	ALUMINIUM	4W	3000K	540 Lm	190 Lm	152,40 B

## FOLD 2

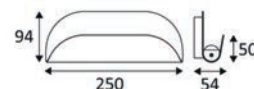
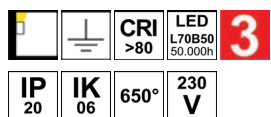

- Applique murale décorative.
- Eclairage indirect.
- Convertisseur non dimmable intégré dans l'appareil.

FOLD 2	MATÉRIE	LED	T°	LED Lumen	System Lumen	€	
WA237WW30	BLANC MAT	ALUMINIUM	6,5W	3000K	450 Lm	375 Lm	180,30 B





## MALTA 1

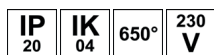
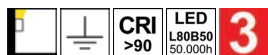

- Applique murale décorative.
- Eclairage indirect.
- Convertisseur non dimmable intégré dans l'appareil.

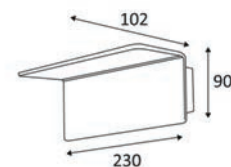

MALTA 1		MATIÈRE	LED	T°	LED Lumen	System Lumen	€
WA12930	BLANC MAT	ALUMINIUM	17W	3000K	1950 Lm	1855 Lm	236,90 B

## MALTA 2

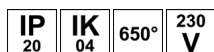

- Applique murale décorative.
- Eclairage indirect.
- Convertisseur dimmable intégré dans l'appareil.
- Compatible avec variateur fin de phase.

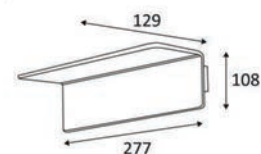

MALTA 2		MATIÈRE	LED	T°	LED Lumen	System Lumen	€
WA164WW30	BLANC MAT	ALUMINIUM	30W	3000K	3550 Lm	3370 Lm	269,90 B



## PLANK 1

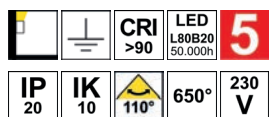

- Applique murale décorative.
- Diffuseur en polycarbonate opalin.
- Eclairage indirect.
- Convertisseur non dimmable intégré dans l'appareil.

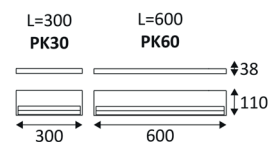

PLANK 1			MATIÈRE	LED	T°	LED Lumen	System Lumen	L (mm)	€	
PK30/1A/3K/W	NEW	BLANC MAT	ALUMINIUM	20W	3000K	2520 Lm	1760 Lm	300	175,00	B
PK30/1A/4K/W	NEW	BLANC MAT	ALUMINIUM	20W	4000K	2730 Lm	1910 Lm	300	175,00	B
PK60/1A/3K/W	NEW	BLANC MAT	ALUMINIUM	40W	3000K	5400 Lm	3775 Lm	600	270,00	B
PK60/1A/4K/W	NEW	BLANC MAT	ALUMINIUM	40W	4000K	5850 Lm	4090 Lm	600	270,00	B



BLANC MAT

BLANC MAT

## PLANK 2

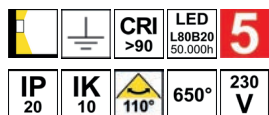

- Applique murale décorative.
- Diffuseurs en polycarbonate opalin.
- Eclairage direct/indirect.
- Convertisseur non dimmable intégré dans l'appareil.

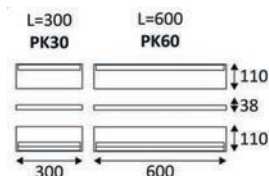

PLANK 2			MATIÈRE	LED	T°	LED Lumen	System Lumen	L (mm)	€	
PK30/2A/3K/W	NEW	BLANC MAT	ALUMINIUM	2x16W	3000K	2x1980 Lm	2x1105 Lm	300	185,00	B
PK30/2A/4K/W	NEW	BLANC MAT	ALUMINIUM	2x16W	4000K	2x2145 Lm	2x1200 Lm	300	185,00	B
PK60/2A/3K/W	NEW	BLANC MAT	ALUMINIUM	2x32W	3000K	2x4030 Lm	2x2820 Lm	600	295,00	B
PK60/2A/4K/W	NEW	BLANC MAT	ALUMINIUM	2x32W	4000K	2x4370 Lm	2x3055 Lm	600	295,00	B



BLANC MAT

BLANC MAT



## LONGA

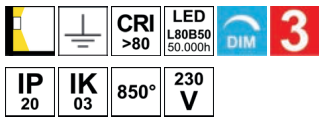

- Applique murale décorative.
- Eclairage "up&down".
- Convertisseur dimmable intégré dans l'appareil.
- Compatible avec variateur début et fin de phase.

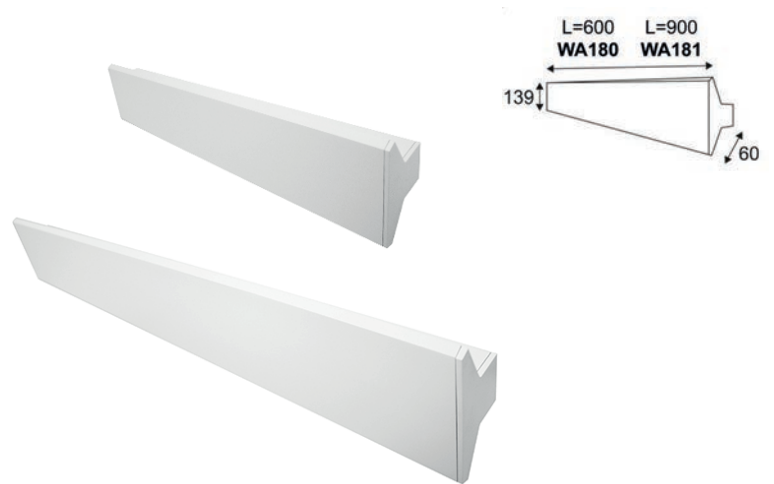

LONGA	MATÉRIE	LED	T°	LED Lumen	System Lumen	L (mm)	€
WA180WW05	NOIR MAT	ALUMINIUM	2x12W	3000K	2800 Lm	2661 Lm	600 281,20 B
WA180WW30	BLANC MAT	ALUMINIUM	2x12W	3000K	2800 Lm	2661 Lm	600 281,20 B
WA181WW05	NOIR MAT	ALUMINIUM	2x15W	3000K	3300 Lm	3100 Lm	900 343,00 B
WA181WW30	BLANC MAT	ALUMINIUM	2x15W	3000K	3300 Lm	3100 Lm	900 343,00 B





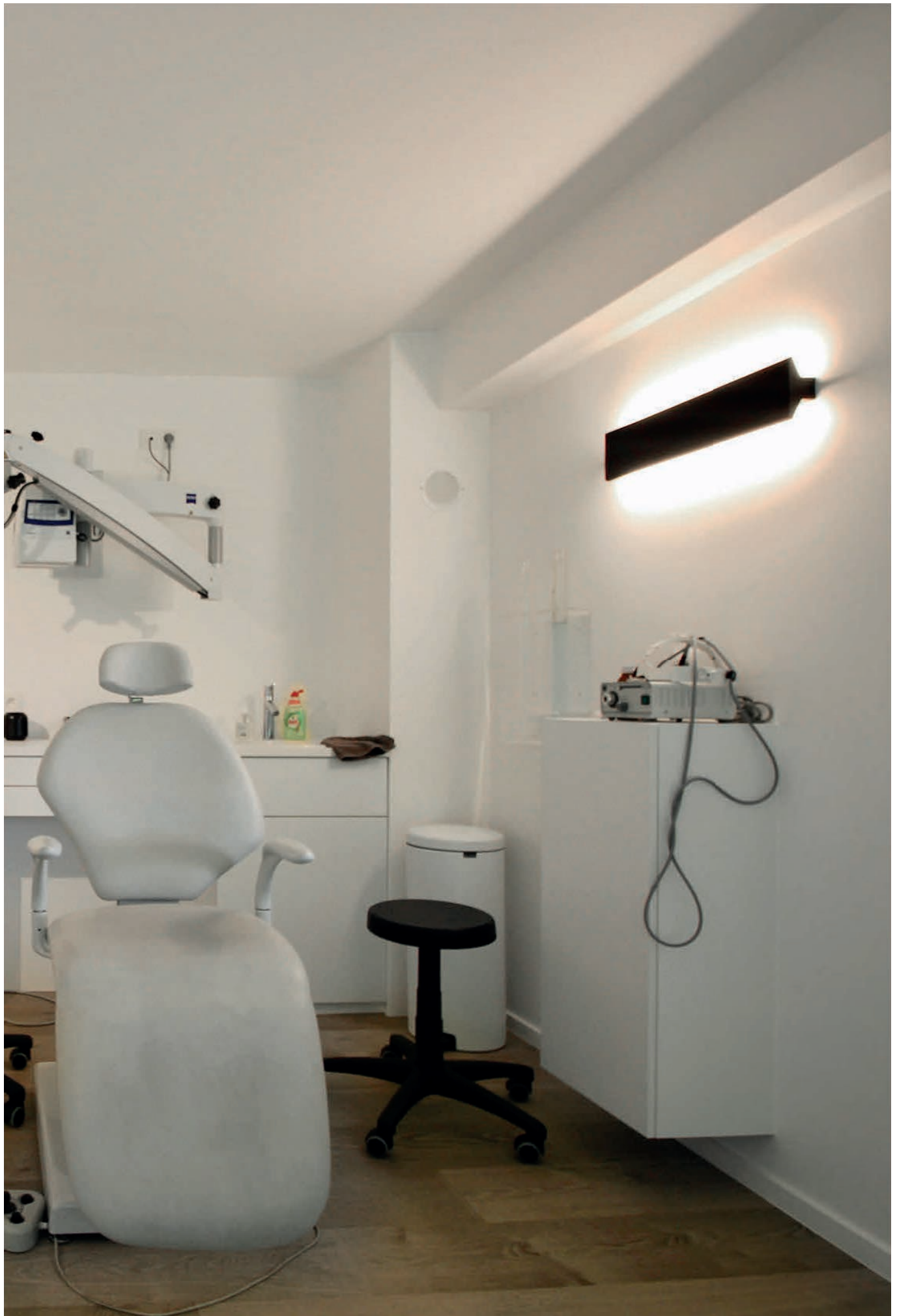

# INDIGO

LIGHTING



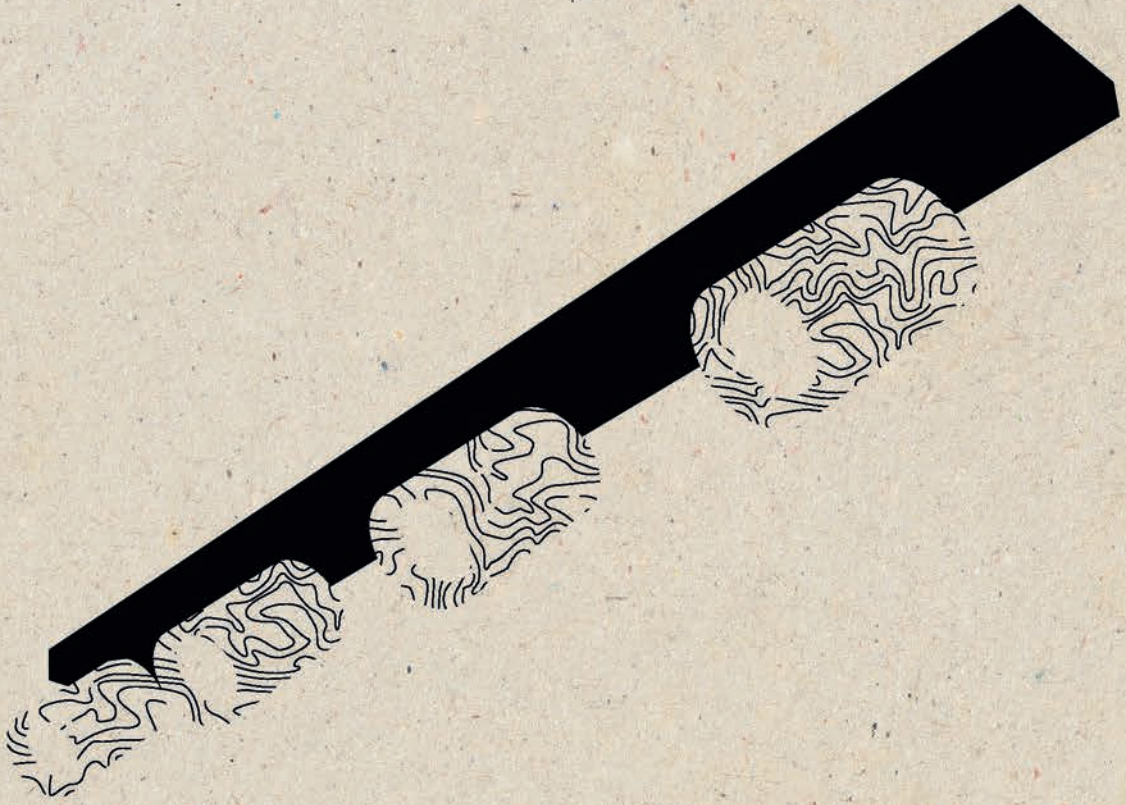

## **PLAFONNIERS**

## ALBA R GU10

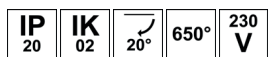

- Plafonnier rond orientable.

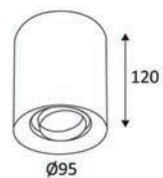

ALBA R GU10		MATIÈRE	SOCKET	LAMP	Watt Max	€
WA19505	■ NOIR MAT	ALUMINIUM	GU10	PAR16 LED	10W	60,80 B
WA19530	■ BLANC MAT	ALUMINIUM	GU10	PAR16 LED	10W	60,80 B



NOIR MAT



BLANC MAT





## ALBA S GU10

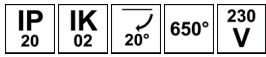

- Plafonnier carré orientable.

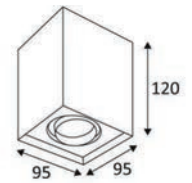

ALBA S GU10		MATIÈRE	SOCKET	LAMP	Watt Max	€
WA19605	■ NOIR MAT	ALUMINIUM	GU10	PAR16 LED	10W	77,30 B
WA19630	■ BLANC MAT	ALUMINIUM	GU10	PAR16 LED	10W	77,30 B



NOIR MAT



BLANC MAT



## LUPO 1 GU10



- Plafonnier carré orientable.

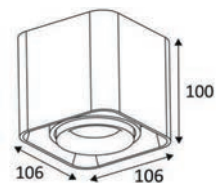

LUPO 1 GU10		MATIÈRE	SOCKET	LAMP	Watt Max	€
WA20305	NOIR MAT	ALUMINIUM	GU10	PAR16 LED	10W	77,30 B
WA20318	NOIR - DORE	ALUMINIUM	GU10	PAR16 LED	10W	77,30 B
WA20330	BLANC MAT	ALUMINIUM	GU10	PAR16 LED	10W	77,30 B



NOIR MAT



BLANC MAT



### LUPO 1

DANS LA MÊME GAMME  
PAGE 212

## MANYL 2 GU10

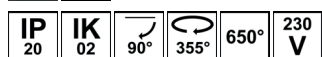

- Plafonnier rond orientable.

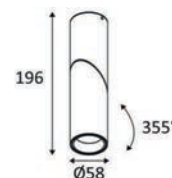

MANYL 2 GU10		MATIÈRE	SOCKET	LAMP	Watt Max	€
WA20205	NOIR MAT	ALUMINIUM	GU10	PAR16 LED	10W	112,30 B
WA20230	BLANC MAT	ALUMINIUM	GU10	PAR16 LED	10W	112,30 B



NOIR MAT



BLANC MAT



### MANYL 2

DANS LA MÊME GAMME  
PAGE 214

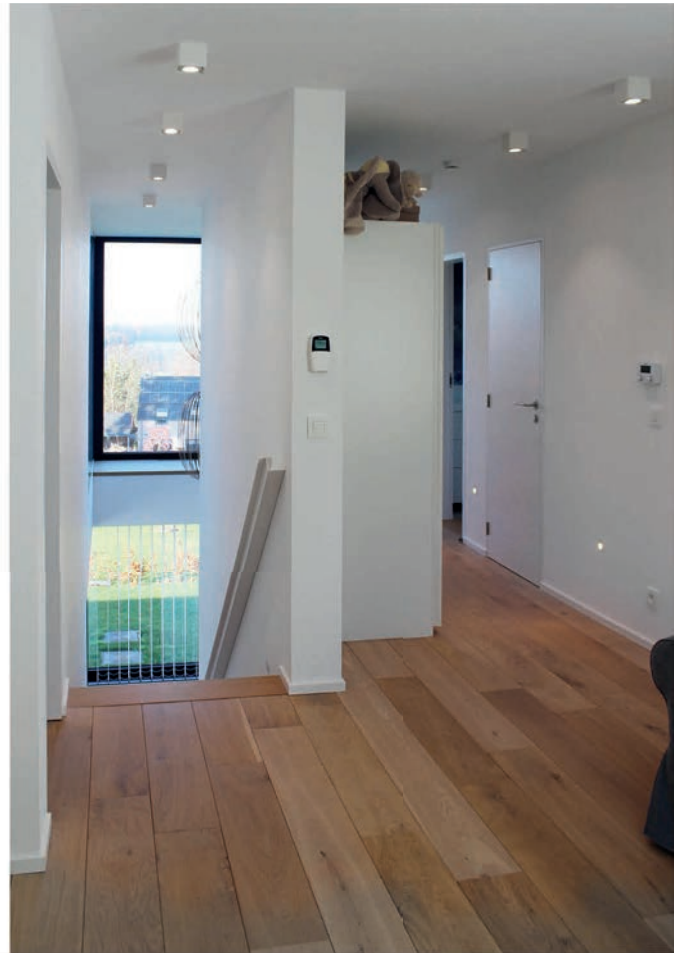

## OKTO GU10

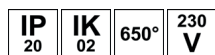

- Plafonnier rond fixe.

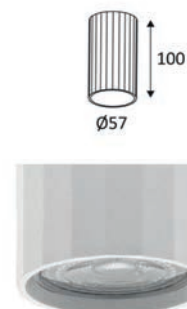

OKTO GU10		MATIÈRE	SOCKET	LAMP	Watt Max	€
WA22905		NOIR MAT	ALUMINIUM	GU10	PAR16 LED	10W 36,10 B
WA22930		BLANC MAT	ALUMINIUM	GU10	PAR16 LED	10W 36,10 B
WA22910		CHAMPAGNE	ALUMINIUM	GU10	PAR16 LED	10W 38,10 B
WA22907		OR ROSE	ALUMINIUM	GU10	PAR16 LED	10W 38,10 B
WA22977		ROSE	ALUMINIUM	GU10	PAR16 LED	10W 39,10 B



NOIR MAT



BLANC MAT



CHAMPAGNE



OR ROSE



ROSE



### OKTO P GU10

DANS LA MÊME GAMME  
PAGE 240



### OKTO 2 GU10

DANS LA MÊME GAMME  
PAGE 162

## OKTO C GU10

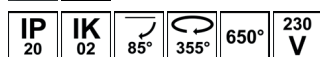

- Applique murale ou plafonnier rond orientable.

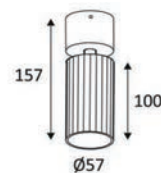

OKTO C GU10		MATIÈRE	SOCKET	LAMP	Watt Max	€
WA23005		NOIR MAT	ALUMINIUM	GU10	PAR16 LED	10W 57,70 B
WA23008		NOIR MAT - CHAMPAGNE	ALUMINIUM	GU10	PAR16 LED	10W 58,70 B
WA23006		NOIR MAT - OR ROSE	ALUMINIUM	GU10	PAR16 LED	10W 58,70 B
WA23083		NOIR MAT - ROSE	ALUMINIUM	GU10	PAR16 LED	10W 58,70 B
WA23030		BLANC MAT	ALUMINIUM	GU10	PAR16 LED	10W 57,70 B
WA23049		BLANC MAT - CHAMPAGNE	ALUMINIUM	GU10	PAR16 LED	10W 58,70 B
WA23002		BLANC MAT - OR ROSE	ALUMINIUM	GU10	PAR16 LED	10W 58,70 B
WA23082		BLANC MAT - ROSE	ALUMINIUM	GU10	PAR16 LED	10W 58,70 B



NOIR MAT



NOIR MAT -  
CHAMPAGNE



NOIR MAT - OR  
ROSE



NOIR MAT - ROSE



BLANC MAT



BLANC MAT -  
CHAMPAGNE



BLANC MAT - OR  
ROSE



BLANC MAT - ROSE





## OKTO 1 C GU10

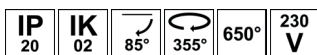

- Applique murale ou plafonnier rond orientable.



OKTO 1 C GU10	MATIÈRE	SOCKET	LAMP	Watt Max	€
WA23105	NOIR MAT ALUMINIUM	GU10	PAR16 LED	10W	53,60 B
WA23108	NOIR MAT - CHAMPAGNE ALUMINIUM	GU10	PAR16 LED	10W	57,70 B
WA23106	NOIR MAT - OR ROSE ALUMINIUM	GU10	PAR16 LED	10W	57,70 B
WA23183	NOIR MAT - ROSE ALUMINIUM	GU10	PAR16 LED	10W	57,70 B
WA23130	BLANC MAT ALUMINIUM	GU10	PAR16 LED	10W	53,60 B
WA23149	BLANC MAT - CHAMPAGNE ALUMINIUM	GU10	PAR16 LED	10W	57,70 B
WA23102	BLANC MAT - OR ROSE ALUMINIUM	GU10	PAR16 LED	10W	57,70 B
WA23182	BLANC MAT - ROSE ALUMINIUM	GU10	PAR16 LED	10W	57,70 B



NOIR MAT



NOIR MAT - CHAMPAGNE



NOIR MAT - OR ROSE



NOIR MAT - ROSE



BLANC MAT



BLANC MAT - CHAMPAGNE



BLANC MAT - OR ROSE



BLANC MAT - ROSE

## OKTO 2 C GU10

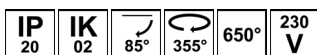

- Applique murale ou plafonnier orientable.

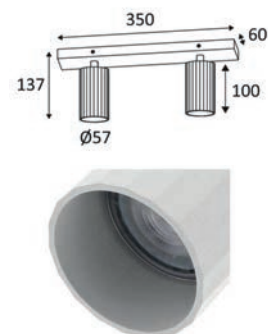

OKTO 2 C GU10	MATIÈRE	SOCKET	LAMP	Watt Max	€
WA23205	NOIR MAT ALUMINIUM	GU10	PAR16 LED	2x10W	82,40 B
WA23208	NOIR MAT - CHAMPAGNE ALUMINIUM	GU10	PAR16 LED	2x10W	87,60 B
WA23206	NOIR MAT - OR ROSE ALUMINIUM	GU10	PAR16 LED	2x10W	87,60 B
WA23283	NOIR MAT - ROSE ALUMINIUM	GU10	PAR16 LED	2x10W	87,60 B
WA23230	BLANC MAT ALUMINIUM	GU10	PAR16 LED	2x10W	82,40 B
WA23249	BLANC MAT - CHAMPAGNE ALUMINIUM	GU10	PAR16 LED	2x10W	87,60 B
WA23202	BLANC MAT - OR ROSE ALUMINIUM	GU10	PAR16 LED	2x10W	87,60 B
WA23282	BLANC MAT - ROSE ALUMINIUM	GU10	PAR16 LED	2x10W	87,60 B



NOIR MAT



NOIR MAT - CHAMPAGNE



NOIR MAT - OR ROSE



NOIR MAT - ROSE



BLANC MAT



BLANC MAT - CHAMPAGNE



BLANC MAT - OR ROSE



BLANC MAT - ROSE



## OKTO 4 C GU10

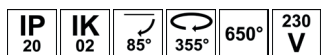

- Applique murale ou plafonnier orientable.



OKTO 4 C GU10		MATIÈRE	SOCKET	LAMP	Watt Max	€
WA23305	■	NOIR MAT	ALUMINIUM	GU10	PAR16 LED	4x10W 151,40 B
WA23308	■	NOIR MAT - CHAMPAGNE	ALUMINIUM	GU10	PAR16 LED	4x10W 162,70 B
WA23306	■	NOIR MAT - OR ROSE	ALUMINIUM	GU10	PAR16 LED	4x10W 162,70 B
WA23383	■	NOIR MAT - ROSE	ALUMINIUM	GU10	PAR16 LED	4x10W 159,70 B
WA23330	■	BLANC MAT	ALUMINIUM	GU10	PAR16 LED	4x10W 151,40 B
WA23349	■	BLANC MAT - CHAMPAGNE	ALUMINIUM	GU10	PAR16 LED	4x10W 162,70 B
WA23302	■	BLANC MAT - OR ROSE	ALUMINIUM	GU10	PAR16 LED	4x10W 162,70 B
WA23382	■	BLANC MAT - ROSE	ALUMINIUM	GU10	PAR16 LED	4x10W 162,70 B

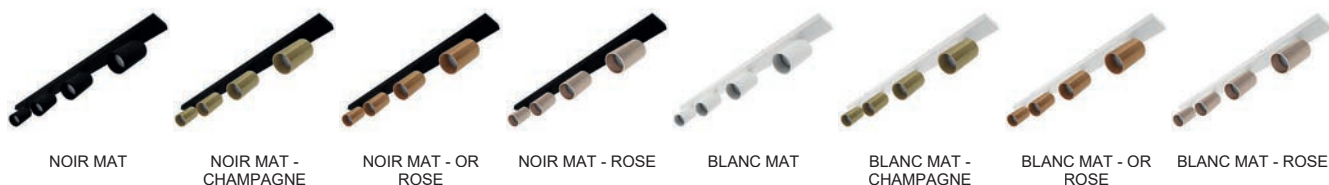

## MOLY GU10

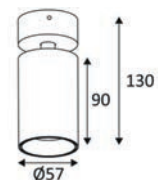
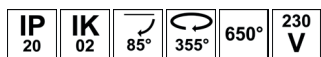

- Applique murale ou plafonnier rond orientable.

MOLY GU10		MATIÈRE	SOCKET	LAMP	Watt Max	€
WA19405	■ NOIR MAT	ALUMINIUM	GU10	PAR16 LED	10W	53,60 B
WA19430	■ BLANC MAT	ALUMINIUM	GU10	PAR16 LED	10W	53,60 B



NOIR MAT

BLANC MAT





## YUKO GU10

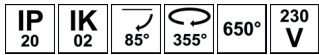

- Plafonnier rond orientable.

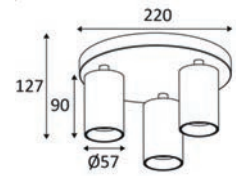

YUKO GU10		MATIÈRE	SOCKET	LAMP	Watt Max	€
WA19805	■ NOIR MAT	ALUMINIUM	GU10	PAR16 LED	3x10W	93,70 B
WA19830	■ BLANC MAT	ALUMINIUM	GU10	PAR16 LED	3x10W	93,70 B



NOIR MAT



BLANC MAT

## NOLY GU10

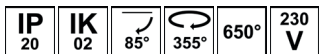

- Applique murale ou plafonnier orientable.

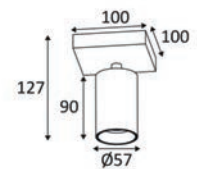

NOLY GU10		MATIÈRE	SOCKET	LAMP	Watt Max	€
WA19705	■ NOIR MAT	ALUMINIUM	GU10	PAR16 LED	10W	52,50 B
WA19730	■ BLANC MAT	ALUMINIUM	GU10	PAR16 LED	10W	52,50 B



NOIR MAT



BLANC MAT

## RIVA 2 GU10

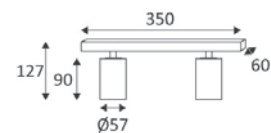
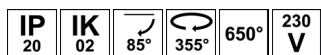

- Applique murale ou plafonnier orientable.

RIVA 2 GU10	MATIÈRE	SOCKET	LAMP	Watt Max	€
WA19905	■ NOIR MAT	ALUMINIUM	PAR16 LED	2x10W	87,60 B
WA19930	■ BLANC MAT	ALUMINIUM	PAR16 LED	2x10W	87,60 B



NOIR MAT



BLANC MAT

## RIVA 3 GU10

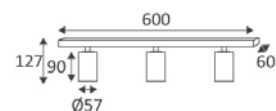
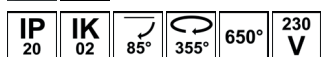

- Applique murale ou plafonnier orientable.

RIVA 3 GU10	MATIÈRE	SOCKET	LAMP	Watt Max	€
WA20005	■ NOIR MAT	ALUMINIUM	PAR16 LED	3x10W	116,40 B
WA20030	■ BLANC MAT	ALUMINIUM	PAR16 LED	3x10W	116,40 B



NOIR MAT



BLANC MAT



## RIVA 4 GU10

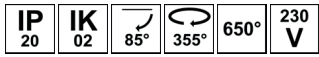

- Applique murale ou plafonnier orientable.



RIVA 4 GU10		MATIÈRE	SOCKET	LAMP	Watt Max	€
WA20105	■ NOIR MAT	ALUMINIUM	GU10	PAR16 LED	4x10W	152,40 B
WA20130	■ BLANC MAT	ALUMINIUM	GU10	PAR16 LED	4x10W	152,40 B



NOIR MAT



BLANC MAT



## EVA 62 R

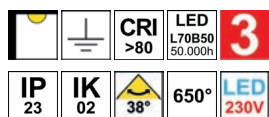

- Spot apparent rond.
- Ne nécessite pas de convertisseur.
- Non dimmable.

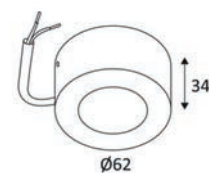

EVA 62 R		MATIÈRE	LED	T°	LED Lumen	System Lumen	€
DW1120R05	■ NOIR MAT	ALUMINIUM	7W	3000K	455 Lm	335 Lm	78,30 B
DW1120R30	■ BLANC MAT	ALUMINIUM	7W	3000K	455 Lm	335 Lm	78,30 B



NOIR MAT



BLANC MAT

## EVA 62 S

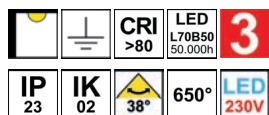

- Spot apparent carré.
- Ne nécessite pas de convertisseur.
- Non dimmable.

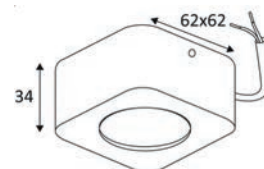

EVA 62 S		MATIÈRE	LED	T°	LED Lumen	System Lumen	€
DW1120S05	■ NOIR MAT	ALUMINIUM	7W	3000K	455 Lm	335 Lm	79,30 B
DW1120S30	■ BLANC MAT	ALUMINIUM	7W	3000K	455 Lm	335 Lm	79,30 B



NOIR MAT



BLANC MAT





## HAPPY 1

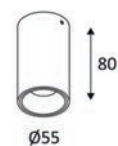
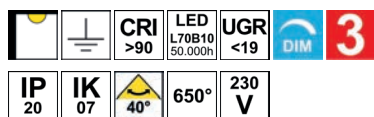

- Plafonnier rond fixe.
- Convertisseur dimmable intégré dans l'appareil.

HAPPY 1	MATÉRIE	LED	T°	LED Lumen	System Lumen	€
WA238WW05	NOIR MAT ALUMINIUM	7W	3000K	600 Lm	435 Lm	105,10 B
WA238WW08	NOIR MAT - CHAMPAGNE ALUMINIUM	7W	3000K	600 Lm	435 Lm	112,30 B
WA238WW17	NOIR MAT - ARGENT ALUMINIUM	7W	3000K	600 Lm	435 Lm	112,30 B
WA238WW23	NOIR MAT - CHROME NOIR ALUMINIUM	7W	3000K	600 Lm	435 Lm	112,30 B
WA238WW30	BLANC MAT ALUMINIUM	7W	3000K	600 Lm	435 Lm	105,10 B
WA238WW49	BLANC MAT - CHAMPAGNE ALUMINIUM	7W	3000K	600 Lm	435 Lm	112,30 B
WA238WW53	BLANC MAT - ARGENT ALUMINIUM	7W	3000K	600 Lm	435 Lm	112,30 B
WA238WW22	BLANC MAT - CHROME NOIR ALUMINIUM	7W	3000K	600 Lm	435 Lm	112,30 B



NOIR MAT



NOIR MAT - CHAMPAGNE



NOIR MAT - ARGENT



NOIR MAT - CHROME NOIR



BLANC MAT



BLANC MAT - CHAMPAGNE



BLANC MAT - ARGENT



BLANC MAT - CHROME NOIR





## HAPPY 2

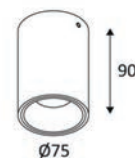
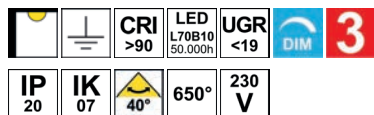

- Plafonnier rond fixe.
- Convertisseur dimmable intégré dans l'appareil.

HAPPY 2	MATIÈRE	LED	T°	LED Lumen	System Lumen	€
WA239WW05	NOIR MAT ALUMINIUM	13W	3000K	1155 Lm	855 Lm	124,60 B
WA239WW08	NOIR MAT - CHAMPAGNE ALUMINIUM	13W	3000K	1155 Lm	855 Lm	137,00 B
WA239WW17	NOIR MAT - ARGENT ALUMINIUM	13W	3000K	1155 Lm	855 Lm	137,00 B
WA239WW23	NOIR MAT - CHROME NOIR ALUMINIUM	13W	3000K	1155 Lm	855 Lm	137,00 B
WA239WW30	BLANC MAT ALUMINIUM	13W	3000K	1155 Lm	855 Lm	124,60 B
WA239WW49	BLANC MAT - CHAMPAGNE ALUMINIUM	13W	3000K	1155 Lm	855 Lm	137,00 B
WA239WW53	BLANC MAT - ARGENT ALUMINIUM	13W	3000K	1155 Lm	855 Lm	137,00 B
WA239WW22	BLANC MAT - CHROME NOIR ALUMINIUM	13W	3000K	1155 Lm	855 Lm	137,00 B



NOIR MAT



NOIR MAT -  
CHAMPAGNE



NOIR MAT - ARGENT



NOIR MAT -  
CHROME NOIR



BLANC MAT



BLANC MAT -  
CHAMPAGNE



BLANC MAT -  
ARGENT



BLANC MAT -  
CHROME NOIR



## HAPPY 3

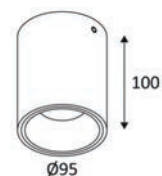
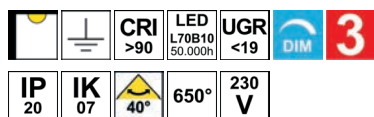

- Plafonnier rond fixe.
- Convertisseur dimmable intégré dans l'appareil.

HAPPY 3	MATIERE	LED	T°	LED Lumen	System Lumen	€
WA240WW05	NOIR MAT ALUMINIUM	18W	3000K	1570 Lm	1170 Lm	145,20 B
WA240WW08	NOIR MAT - CHAMPAGNE ALUMINIUM	18W	3000K	1570 Lm	1170 Lm	158,60 B
WA240WW17	NOIR MAT - ARGENT ALUMINIUM	18W	3000K	1570 Lm	1170 Lm	158,60 B
WA240WW23	NOIR MAT - CHROME NOIR ALUMINIUM	18W	3000K	1570 Lm	1170 Lm	158,60 B
WA240WW30	BLANC MAT ALUMINIUM	18W	3000K	1570 Lm	1170 Lm	145,20 B
WA240WW49	BLANC MAT - CHAMPAGNE ALUMINIUM	18W	3000K	1570 Lm	1170 Lm	158,60 B
WA240WW53	BLANC MAT - ARGENT ALUMINIUM	18W	3000K	1570 Lm	1170 Lm	158,60 B
WA240WW22	BLANC MAT - CHROME NOIR ALUMINIUM	18W	3000K	1570 Lm	1170 Lm	158,60 B



NOIR MAT



NOIR MAT - CHAMPAGNE



NOIR MAT - ARGENT



NOIR MAT - CHROME NOIR



BLANC MAT



BLANC MAT - CHAMPAGNE



BLANC MAT - ARGENT



BLANC MAT - CHROME NOIR

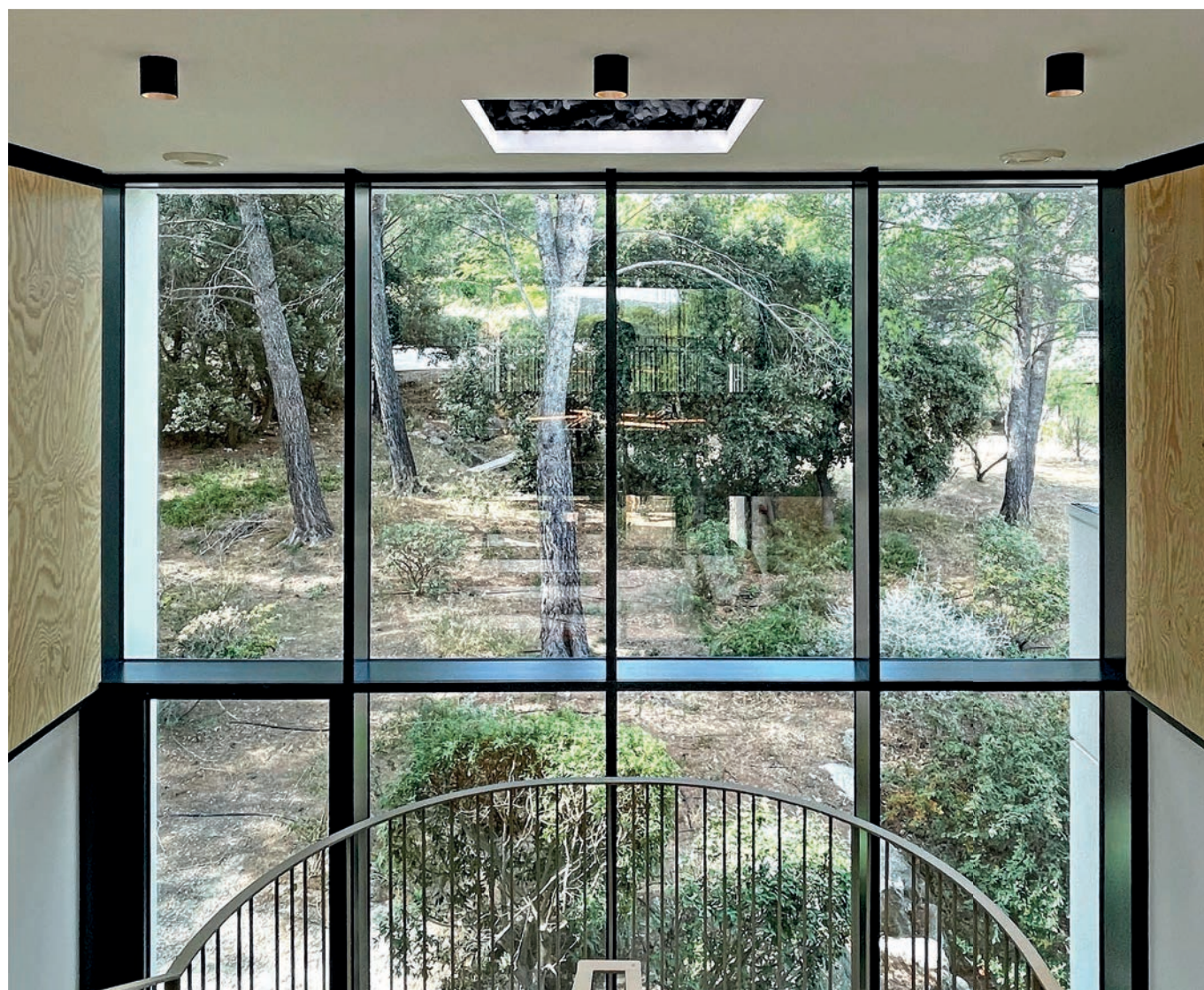



## DOTS C

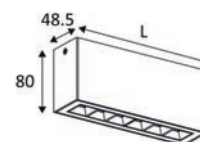
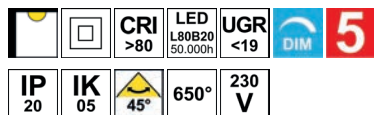

- Plafonnier rectangulaire fixe pour éclairage d'accentuation.
- Réflecteur basse luminance.
- Convertisseur dimmable intégré dans l'appareil.
- Compatible avec variateur début et fin de phase.

DOTS C	MATIÈRE	LED	T°	LED Lumen	System Lumen	L (mm)	€
WA248WW05	NOIR MAT	ALUMINIUM	6W	3000K	470 Lm	300 Lm	108 77,30 B
WA248WW30	BLANC MAT	ALUMINIUM	6W	3000K	470 Lm	300 Lm	108 77,30 B
WA249WW05	NOIR MAT	ALUMINIUM	12W	3000K	940 Lm	565 Lm	188 110,20 B
WA249WW30	BLANC MAT	ALUMINIUM	12W	3000K	940 Lm	565 Lm	188 110,20 B
WA250WW05	NOIR MAT	ALUMINIUM	16W	3000K	1400 Lm	895 Lm	268 127,70 B
WA250WW30	BLANC MAT	ALUMINIUM	16W	3000K	1400 Lm	895 Lm	268 127,70 B
WA251WW05	NOIR MAT	ALUMINIUM	20W	3000K	1880 Lm	1165 Lm	348 148,30 B
WA251WW30	BLANC MAT	ALUMINIUM	20W	3000K	1880 Lm	1165 Lm	348 148,30 B



NOIR MAT

BLANC MAT

NOIR MAT

BLANC MAT

### DOTS

DANS LA MÊME GAMME  
PAGE 82



## LUPO 1

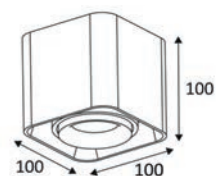
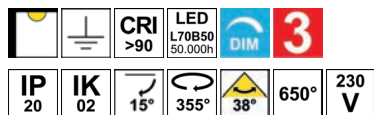

- Plafonnier carré orientable.
- Convertisseur dimmable intégré dans l'appareil.
- Compatible avec variateur début et fin de phase.

LUPO 1		MATIÈRE	LED	T°	LED Lumen	System Lumen	€
WA211WW16	■ NOIR MAT	FONTE D'ALUMINIUM	10W	3000K	500 Lm	435 Lm	113,30 B
WA211WW21	■ BLANC MAT	FONTE D'ALUMINIUM	10W	3000K	500 Lm	435 Lm	113,30 B



NOIR MAT



BLANC MAT



### LUPO 1 GU10

DANS LA MÊME GAMME  
PAGE 196





## LUPO 2

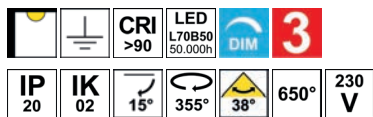

- Plafonnier rectangulaire orientable.
- Convertisseur dimmable intégré dans l'appareil.
- Compatible avec variateur début et fin de phase.

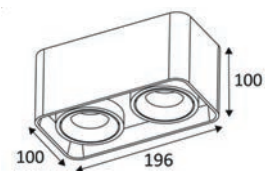

LUPO 2		MATIÈRE	LED	T°	LED Lumen	System Lumen	€
WA212WW16	■ NOIR MAT	FONTE D'ALUMINIUM	2x10W	3000K	2x500 Lm	2x435 Lm	219,40 B
WA212WW21	■ BLANC MAT	FONTE D'ALUMINIUM	2x10W	3000K	2x500 Lm	2x435 Lm	219,40 B



NOIR MAT

BLANC MAT



## MANYL 1

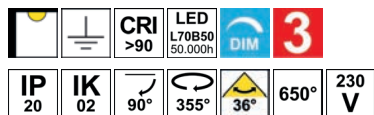

- Plafonnier rond orientable.
- Convertisseur dimmable intégré dans l'appareil.
- Compatible avec variateur début et fin de phase.



MANYL 1	MATIÈRE	LED	T°	LED Lumen	System Lumen	€	
WA193WW16	NOIR MAT	ALUMINIUM	5W	3000K	770 Lm	449 Lm	122,60 B
WA193WW21	BLANC MAT	ALUMINIUM	5W	3000K	770 Lm	449 Lm	122,60 B



NOIR MAT



BLANC MAT

## MANYL 2

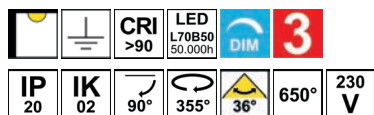

- Plafonnier rond orientable.
- Convertisseur dimmable intégré dans l'appareil.
- Compatible avec variateur début et fin de phase.

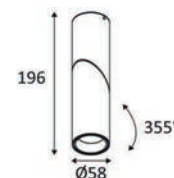

MANYL 2	MATIÈRE	LED	T°	LED Lumen	System Lumen	€	
WA210WW16	NOIR MAT	ALUMINIUM	11W	3000K	1180 Lm	938 Lm	175,10 B
WA210WW21	BLANC MAT	ALUMINIUM	11W	3000K	1180 Lm	938 Lm	175,10 B



NOIR MAT



BLANC MAT



**MANYL 2 GU10**  
DANS LA MÊME GAMME  
PAGE 196



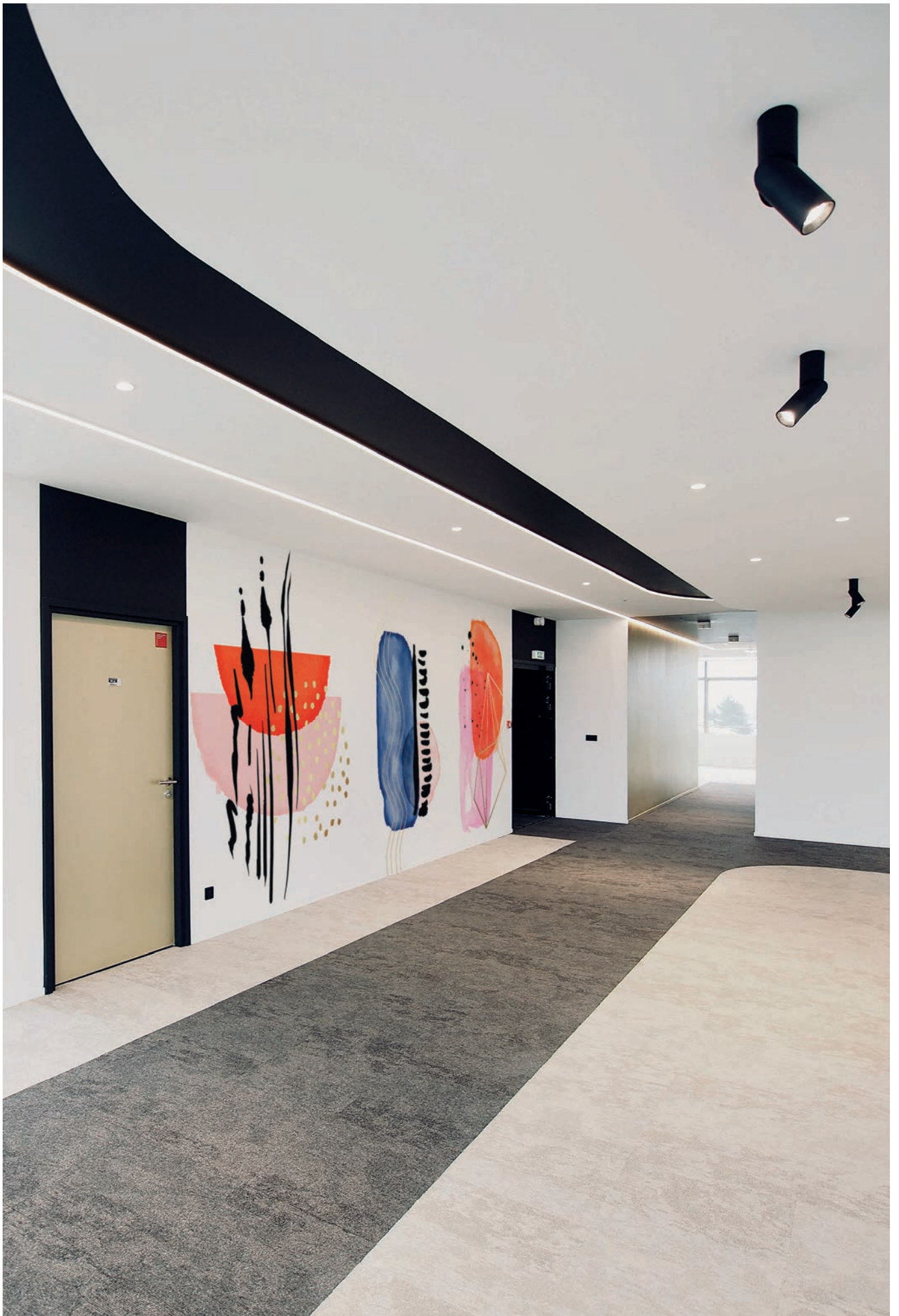

## FILI 4 RX

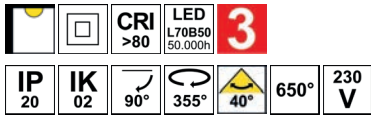

- Plafonnier rond orientable.
- Livré avec réflecteurs doré et argenté.
- Convertisseur non dimmable intégré dans l'appareil.



FILI 4 RX	MATÈRE	LED	T°	LED Lumen	System Lumen	€	
WA161WW05	NOIR MAT	ALUMINIUM	13W	3000K	1180 Lm	791 Lm	175,10 B
WA161WW30	BLANC MAT	ALUMINIUM	13W	3000K	1180 Lm	791 Lm	175,10 B









## AUREA 1 C

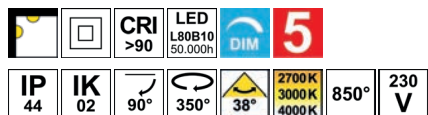

- Applique murale ou plafonnier rond orientable.
- 2700K, 3000K ou 4000K au choix via un interrupteur à l'arrière du luminaire.
- Convertisseur dimmable intégré dans l'appareil.
- Compatible avec variateur début de phase.

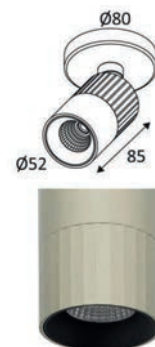

AUREA 1 C		MATIÈRE	LED	T°	LED Lumen	System Lumen	€	
WA25605	■	NOIR MAT	ALUMINIUM	6W	2700-3000-4000K	715 Lm (4000K)	550 Lm (4000K)	93,70 B
WA25608	■	NOIR MAT - CHAMPAGNE	ALUMINIUM	6W	2700-3000-4000K	715 Lm (4000K)	550 Lm (4000K)	106,10 B
WA25683	■	NOIR MAT - ROSE	ALUMINIUM	6W	2700-3000-4000K	715 Lm (4000K)	550 Lm (4000K)	106,10 B
WA25630	■	BLANC MAT	ALUMINIUM	6W	2700-3000-4000K	715 Lm (4000K)	550 Lm (4000K)	93,70 B
WA25649	■	BLANC MAT - CHAMPAGNE	ALUMINIUM	6W	2700-3000-4000K	715 Lm (4000K)	550 Lm (4000K)	106,10 B
WA25682	■	BLANC MAT - ROSE	ALUMINIUM	6W	2700-3000-4000K	715 Lm (4000K)	550 Lm (4000K)	106,10 B



### AUREA P

DANS LA MÊME GAMME  
PAGE 244

## AUREA 2 C

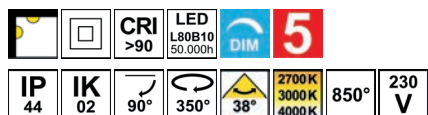

- Applique murale ou plafonnier orientable.
- 2700K, 3000K ou 4000K au choix via un interrupteur à l'arrière du luminaire.
- Convertisseur dimmable intégré dans l'appareil.
- Compatible avec variateur début de phase.

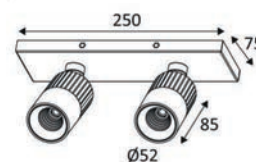

AUREA 2 C		MATIÈRE	LED	T°	LED Lumen	System Lumen	€	
WA25705	■	NOIR MAT	ALUMINIUM	2x6W	2700-3000-4000K	2x715 Lm (4000K)	2x550 Lm (4000K)	190,60 B
WA25708	■	NOIR MAT - CHAMPAGNE	ALUMINIUM	2x6W	2700-3000-4000K	2x715 Lm (4000K)	2x550 Lm (4000K)	213,20 B
WA25783	■	NOIR MAT - ROSE	ALUMINIUM	2x6W	2700-3000-4000K	2x715 Lm (4000K)	2x550 Lm (4000K)	213,20 B
WA25730	■	BLANC MAT	ALUMINIUM	2x6W	2700-3000-4000K	2x715 Lm (4000K)	2x550 Lm (4000K)	190,60 B
WA25749	■	BLANC MAT - CHAMPAGNE	ALUMINIUM	2x6W	2700-3000-4000K	2x715 Lm (4000K)	2x550 Lm (4000K)	213,20 B
WA25782	■	BLANC MAT - ROSE	ALUMINIUM	2x6W	2700-3000-4000K	2x715 Lm (4000K)	2x550 Lm (4000K)	213,20 B



### AUREA P

DANS LA MÊME GAMME  
PAGE 244

## CLAC 1 MINI

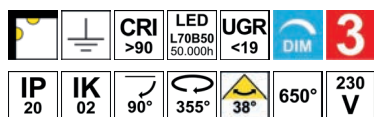

- Applique murale ou plafonnier rond orientable.
- Convertisseur dimmable intégré dans l'appareil.
- Compatible avec variateur fin de phase.

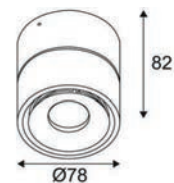

CLAC 1 MINI		MATIÈRE	LED	T°	LED Lumen	System Lumen	€
WA182SW05	■ NOIR MAT	ALUMINIUM	8W	2700K	710 Lm	435 Lm	127,70 B
WA182SW30	■ BLANC MAT	ALUMINIUM	8W	2700K	710 Lm	435 Lm	127,70 B
WA182WW05	■ NOIR MAT	ALUMINIUM	8W	3000K	750 Lm	467 Lm	132,90 B
WA182WW30	■ BLANC MAT	ALUMINIUM	8W	3000K	750 Lm	467 Lm	132,90 B



NOIR MAT



BLANC MAT



### CLIC RDX MINI

DANS LA MÊME GAMME  
PAGE 104

## CLAC 2 MINI

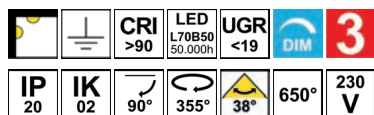

- Applique murale ou plafonnier orientable.
- Convertisseur dimmable intégré dans l'appareil.
- Compatible avec variateur fin de phase.

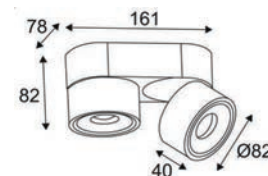

CLAC 2 MINI		MATIÈRE	LED	T°	LED Lumen	System Lumen	€
WA183SW05	■ NOIR MAT	ALUMINIUM	2x8W	2700K	2x710 Lm	2x435 Lm	186,40 B
WA183SW30	■ BLANC MAT	ALUMINIUM	2x8W	2700K	2x710 Lm	2x435 Lm	186,40 B
WA183WW05	■ NOIR MAT	ALUMINIUM	2x8W	3000K	2x750 Lm	2x467 Lm	195,70 B
WA183WW30	■ BLANC MAT	ALUMINIUM	2x8W	3000K	2x750 Lm	2x467 Lm	195,70 B



NOIR MAT



BLANC MAT



## CLAC

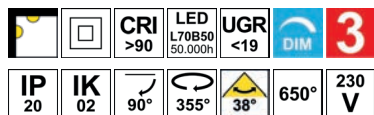

- Applique murale ou plafonnier rond orientable.
- Convertisseur dimmable intégré dans l'appareil.
- Compatible avec variateur fin de phase.

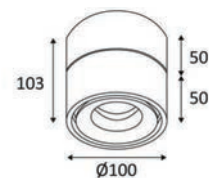

CLAC	MATIERE	LED	T°	LED Lumen	System Lumen	€	
DO225SW05	NOIR MAT	ALUMINIUM	13W	2700K	1120 Lm	798 Lm	195,70 B
DO225SW30	BLANC MAT	ALUMINIUM	13W	2700K	1120 Lm	798 Lm	195,70 B
DO225WW05	NOIR MAT	ALUMINIUM	13W	3000K	1180 Lm	900 Lm	195,70 B
DO225WW30	BLANC MAT	ALUMINIUM	13W	3000K	1180 Lm	900 Lm	195,70 B
DO225WW64	CUIVRE MAT	ALUMINIUM	13W	3000K	1180 Lm	900 Lm	219,40 B



NOIR MAT



BLANC MAT



CUIVRE MAT



### CLIC RDX

DANS LA MÊME GAMME  
PAGE 104

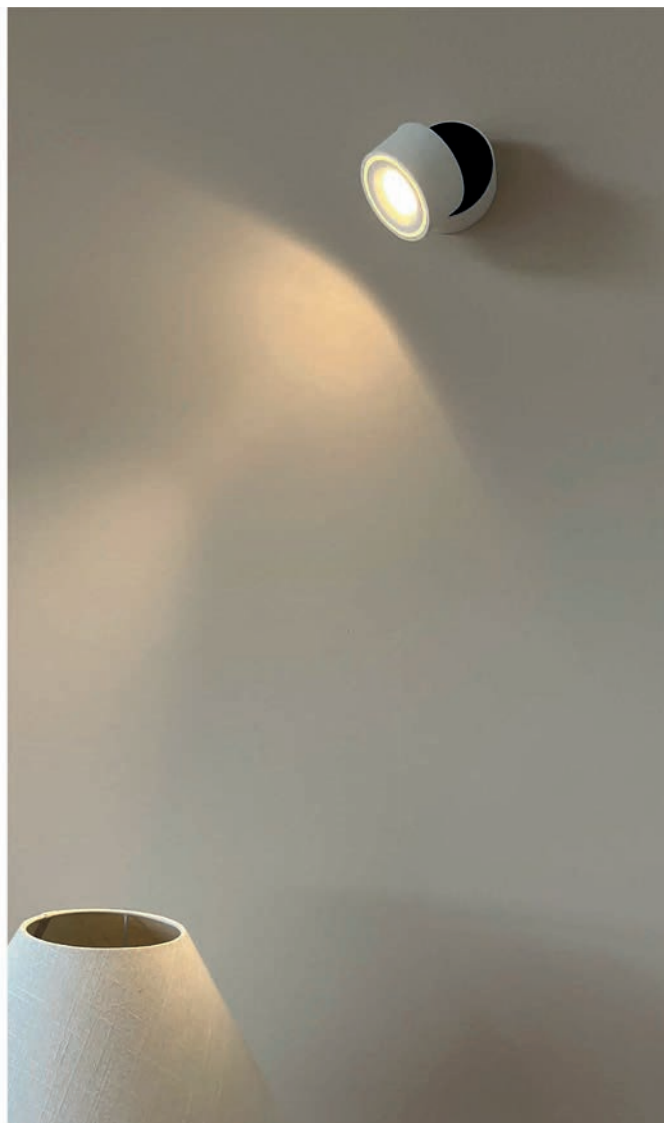

## PIXA 1

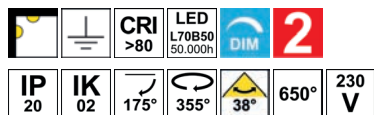

- Applique murale ou plafonnier orientable.
- Convertisseur dimmable intégré dans l'appareil.
- Compatible avec variateur fin de phase.

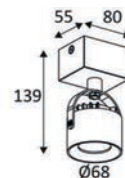

PIXA 1	MATÉRIE	LED	T°	LED Lumen	System Lumen	€	
WA13205	NOIR MAT	FONTE D'ALUMINIUM	10W	3000K	1200 Lm	744 Lm	175,10 B
WA13230	BLANC MAT	FONTE D'ALUMINIUM	10W	3000K	1200 Lm	744 Lm	175,10 B



NOIR MAT



BLANC MAT

## PIXA 2

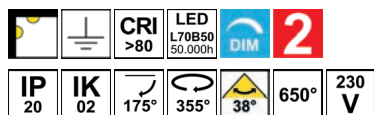

- Applique murale ou plafonnier orientable.
- Convertisseur dimmable intégré dans l'appareil.
- Compatible avec variateur fin de phase.

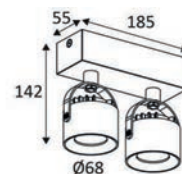

PIXA 2	MATÉRIE	LED	T°	LED Lumen	System Lumen	€	
WA13305	NOIR MAT	FONTE D'ALUMINIUM	2x10W	3000K	2x1200 Lm	2x744 Lm	283,30 B
WA13330	BLANC MAT	FONTE D'ALUMINIUM	2x10W	3000K	2x1200 Lm	2x744 Lm	283,30 B



NOIR MAT



BLANC MAT





## PIXA 3

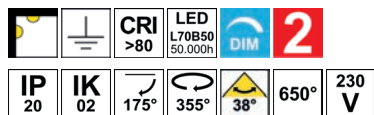

- Applique murale ou plafonnier orientable.
- Convertisseur dimmable intégré dans l'appareil.
- Compatible avec variateur fin de phase.

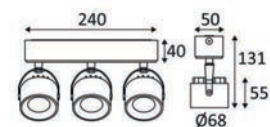

PIXA 3		MATIÈRE	LED	T°	LED Lumen	System Lumen	€
WA13405	■ NOIR MAT	FONTE D'ALUMINIUM	3x10W	3000K	3x1200 Lm	3x744 Lm	409,90 B
WA13430	■ BLANC MAT	FONTE D'ALUMINIUM	3x10W	3000K	3x1200 Lm	3x744 Lm	409,90 B



NOIR MAT



BLANC MAT







## TIPO 1 C

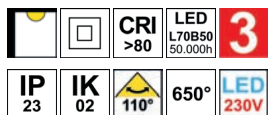

- Plafonnier extra-plat rond.
- Ne nécessite pas de convertisseur.
- Non dimmable.

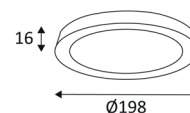

TIPO 1 C		MATIÈRE	LED	T°	LED Lumen	System Lumen	€
DO263WW30	BLANC MAT	COMPOSITE	18W	3000K	1350 Lm	1000 Lm	77,30 B
DO263NW30	BLANC MAT	COMPOSITE	18W	4000K	1400 Lm	1040 Lm	77,30 B

## TIPO 2 C

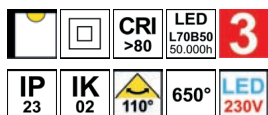

- Plafonnier extra-plat rond.
- Ne nécessite pas de convertisseur.
- Non dimmable.

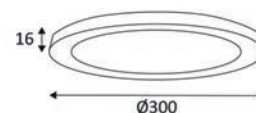

TIPO 2 C		MATIÈRE	LED	T°	LED Lumen	System Lumen	€
WA179WW30	BLANC MAT	COMPOSITE	24W	3000K	1950 Lm	1500 Lm	89,60 B
WA179NW30	BLANC MAT	COMPOSITE	24W	4000K	2100 Lm	1620 Lm	89,60 B

## JUNE 1 C

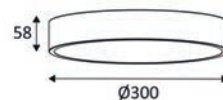
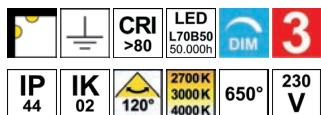

- Applique murale ou plafonnier décoratif.
- Diffuseur en PS opalin.
- 2700K, 3000K ou 4000K au choix via un interrupteur dans le luminaire.
- Convertisseur dimmable intégré dans l'appareil.
- Compatible avec variateur début et fin de phase.

JUNE 1 C		MATIÈRE	LED	T°	LED Lumen	System Lumen	€
WA22205	NOIR MAT	ALUMINIUM	18W	2700-3000-4000K	3300 Lm (4000K)	1775 Lm (4000K)	114,30 B
WA22230	BLANC MAT	ALUMINIUM	18W	2700-3000-4000K	3300 Lm (4000K)	1775 Lm (4000K)	114,30 B



NOIR MAT

BLANC MAT



### JUNE 1 P

DANS LA MÊME GAMME  
PAGE 248





## JUNE 2 C

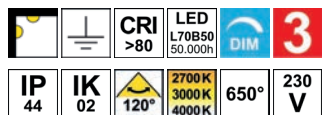

- Applique murale ou plafonnier décoratif.
- Diffuseur en PS opalin.
- 2700K, 3000K ou 4000K au choix via un interrupteur dans le luminaire.
- Convertisseur dimmable intégré dans l'appareil.
- Compatible avec variateur début et fin de phase.



JUNE 2 C		MATIÈRE	LED	T°	LED Lumen	System Lumen	€
WA22305	NOIR MAT	ALUMINIUM	30W	2700-3000-4000K	5600 Lm (4000K)	3325 Lm (4000K)	184,40 B
WA22330	BLANC MAT	ALUMINIUM	30W	2700-3000-4000K	5600 Lm (4000K)	3325 Lm (4000K)	184,40 B



NOIR MAT



BLANC MAT



### JUNE 2 P

DANS LA MÊME GAMME  
PAGE 249

## JUNE 3 C

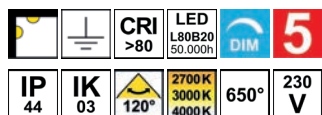

- Applique murale ou plafonnier décoratif.
- Diffuseur en PS opalin.
- 2700K, 3000K ou 4000K au choix via un interrupteur dans le luminaire.
- Convertisseur dimmable intégré dans l'appareil.
- Compatible avec variateur début et fin de phase.

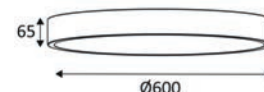

JUNE 3 C		MATIÈRE	LED	T°	LED Lumen	System Lumen	€
WA24105	NOIR MAT	ALUMINIUM	50W	2700-3000-4000K	8000 Lm (4000K)	5920 Lm (4000K)	280,20 B
WA24130	BLANC MAT	ALUMINIUM	50W	2700-3000-4000K	8000 Lm (4000K)	5920 Lm (4000K)	280,20 B



NOIR MAT



BLANC MAT



### JUNE 3 P

DANS LA MÊME GAMME  
PAGE 249

NEW

## NOVA CSP 1 C

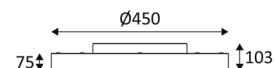
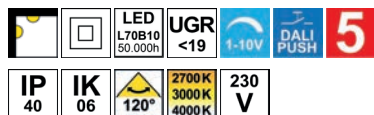

- Applique murale ou plafonnier rond.
- Diffuseur microprismatique.
- 2700K, 3000K ou 4000K au choix via un interrupteur dans le luminaire.
- Convertisseur dimmable DALI, Push-Dim et 1-10V intégré dans l'appareil.
- Kit d'éclairage indirect non-dimmable en option.

NOVA CSP 1 C		MATIÈRE	LED	T°	LED Lumen	System Lumen	€
NVB45DS	NEW	NOIR MAT - DORÉ	ALUMINIUM	26W	2700-3000-4000K	3930 Lm (4000K)	3000 Lm (4000K) 555,80 A
NVW45DS	NEW	BLANC MAT - DORÉ	ALUMINIUM	26W	2700-3000-4000K	3930 Lm (4000K)	3000 Lm (4000K) 555,80 A

ACCESSOIRES	MATIÈRE	DESCRIPTION	€		NOVA CSP 1 P
NV45UPM	NEW	POLYCARBONATE	KIT UPLIGHT NOVA 1 13W 3000K 1100Lm	122,60 A	DANS LA MÊME GAMME PAGE 250



NOIR MAT - DORÉ BLANC MAT - DORÉ

NEW

## NOVA CSP 2 C

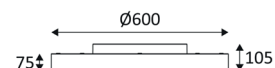
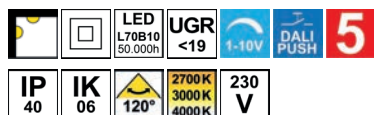

- Applique murale ou plafonnier rond.
- Diffuseur microprismatique.
- 2700K, 3000K ou 4000K au choix via un interrupteur dans le luminaire.
- Convertisseur dimmable DALI, Push-Dim et 1-10V intégré dans l'appareil.
- Kit d'éclairage indirect non-dimmable en option.

NOVA CSP 2 C		MATIÈRE	LED	T°	LED Lumen	System Lumen	€
NVB60DS	NEW	NOIR MAT - DORÉ	ALUMINIUM	40W	2700-3000-4000K	6075 Lm (4000K)	4800 Lm (4000K) 754,50 A
NVW60DS	NEW	BLANC MAT - DORÉ	ALUMINIUM	40W	2700-3000-4000K	6075 Lm (4000K)	4800 Lm (4000K) 754,50 A

ACCESSOIRES	MATIÈRE	DESCRIPTION	€		NOVA CSP 2 P
NV60UPM	NEW	POLYCARBONATE	KIT UPLIGHT NOVA 2 20W 3000K 1700Lm	178,90 A	DANS LA MÊME GAMME PAGE 250



NOIR MAT - DORÉ BLANC MAT - DORÉ



## NOVA CSP 3 C

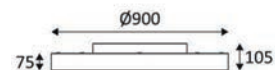

NEW

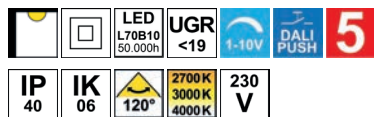

- Plafonnier rond.
- Diffuseur micropismatique.
- 2700K, 3000K ou 4000K au choix via un interrupteur dans le luminaire.
- Convertisseur dimmable DALI, Push-Dim et 1-10V intégré dans l'appareil.
- Kit d'éclairage indirect non-dimmable en option.



NOVA CSP 3 C		MATIÈRE	LED	T°	LED Lumen	System Lumen	€
NVB90DS	<b>NEW</b>	NOIR MAT - DORÉ	ALUMINIUM	68W	2700-3000-4000K	10740 Lm (4000K)	9000 Lm (4000K) 1.510,30 A
NVW90DS	<b>NEW</b>	BLANC MAT - DORÉ	ALUMINIUM	68W	2700-3000-4000K	10740 Lm (4000K)	9000 Lm (4000K) 1.510,30 A

ACCESSOIRES	MATIÈRE	DESCRIPTION	€		NOVA CSP 3 P
NV90UPM	<b>NEW</b>	POLYCARBONATE	KIT UPLIGHT NOVA 3 28W 3000K 2400Lm	271,60 A	 DANS LA MÊME GAMME PAGE 251



NOIR MAT - DORÉ    BLANC MAT - DORÉ



## CAPRI R 1 C

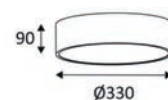
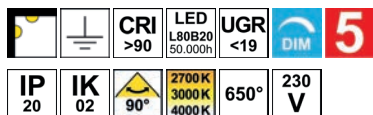

- Applique murale ou plafonnier.
- Diffuseur PS à structure prismatique.
- 2700K, 3000K ou 4000K au choix via un interrupteur dans le luminaire.
- Convertisseur dimmable coupure de phase ou dimmable DALI-push intégré dans l'appareil.

CAPRI R 1 C		MATIÈRE	LED	T°	LED Lumen	System Lumen	€
<b>DIMMABLE COUPURE DE PHASE</b>							
WA21605	■ NOIR MAT	ALUMINIUM	20W	2700-3000-4000K	2400 Lm (4000K)	1360 Lm (4000K)	233,80 B
WA21630	■ BLANC MAT	ALUMINIUM	20W	2700-3000-4000K	2400 Lm (4000K)	1360 Lm (4000K)	233,80 B
<b>DIMMABLE DALI</b>							
WA21605DA	■ NOIR MAT	ALUMINIUM	20W	2700-3000-4000K	2400 Lm (4000K)	1360 Lm (4000K)	338,90 B
WA21630DA	■ BLANC MAT	ALUMINIUM	20W	2700-3000-4000K	2400 Lm (4000K)	1360 Lm (4000K)	364,60 B



NOIR MAT

BLANC MAT



### CAPRI R 1 P

DANS LA MÊME GAMME  
PAGE 252







## CAPRI R 2 C

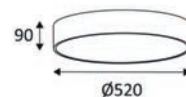
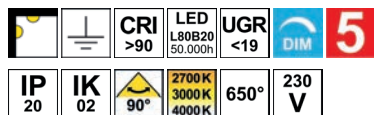

- Applique murale ou plafonnier.
- Diffuseur PS à structure prismatique.
- 2700K, 3000K ou 4000K au choix via un interrupteur dans le luminaire.
- Convertisseur dimmable coupure de phase ou dimmable DALI-push intégré dans l'appareil.

CAPRI R 2 C	MATIÈRE	LED	T°	LED Lumen	System Lumen	€
<b>DIMMABLE COUPURE DE PHASE</b>						
WA21705	NOIR MAT	ALUMINIUM	42W	2700-3000-4000K	5150 Lm (4000K)	2910 Lm (4000K) <b>366,70</b> B
WA21730	BLANC MAT	ALUMINIUM	42W	2700-3000-4000K	5150 Lm (4000K)	2910 Lm (4000K) <b>366,70</b> B
<b>DIMMABLE DALI</b>						
WA21705DA	NOIR MAT	ALUMINIUM	42W	2700-3000-4000K	5150 Lm (4000K)	2910 Lm (4000K) <b>496,50</b> B
WA21730DA	BLANC MAT	ALUMINIUM	42W	2700-3000-4000K	5150 Lm (4000K)	2910 Lm (4000K) <b>496,50</b> B



### CAPRI R 2 P

DANS LA MÊME GAMME  
PAGE 252



NOIR MAT

BLANC MAT

## CAPRI R 3 C

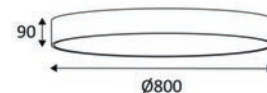
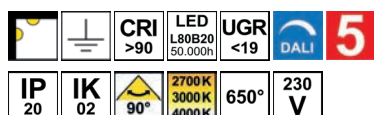

- Applique murale ou plafonnier.
- Diffuseur PS à structure prismatique.
- 2700K, 3000K ou 4000K au choix via un interrupteur dans le luminaire.
- Convertisseur dimmable DALI intégré dans l'appareil.

CAPRI R 3 C	MATIÈRE	LED	T°	LED Lumen	System Lumen	€
WA21805DA	NOIR MAT	ALUMINIUM	105W	2700-3000-4000K	11800 Lm (4000K)	7070 Lm (4000K) <b>1.145,40</b> B
WA21830DA	BLANC MAT	ALUMINIUM	105W	2700-3000-4000K	11800 Lm (4000K)	7070 Lm (4000K) <b>1.145,40</b> B

ACCESSOIRES	DESCRIPTION	L (mm)	€
CD127	DALI PCU GESTION ECLAIRAGE	48	<b>251,30</b> B



### CAPRI R 3 P

DANS LA MÊME GAMME  
PAGE 253



NOIR MAT

BLANC MAT

## CAPRI S 1 C

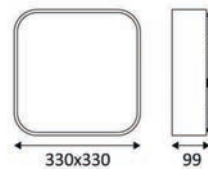
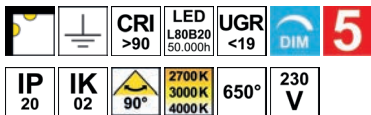

- Applique murale ou plafonnier.
- Diffuseur PS à structure prismatique.
- 2700K, 3000K ou 4000K au choix via un interrupteur dans le luminaire.
- Convertisseur dimmable coupure de phase ou dimmable DALI-push intégré dans l'appareil.



CAPRI S 1 C	MATIÈRE	LED	T°	LED Lumen	System Lumen	€
<b>DIMMABLE COUPURE DE PHASE</b>						
WA24205	NOIR MAT	ALUMINIUM	20W 2700-3000-4000K	2400 Lm (4000K)	1335 Lm (4000K)	255,40 B
WA24230	BLANC MAT	ALUMINIUM	20W 2700-3000-4000K	2400 Lm (4000K)	1335 Lm (4000K)	255,40 B
<b>DIMMABLE DALI</b>						
WA24205DA	NOIR MAT	ALUMINIUM	20W 2700-3000-4000K	2400 Lm (4000K)	1335 Lm (4000K)	369,80 B
WA24230DA	BLANC MAT	ALUMINIUM	20W 2700-3000-4000K	2400 Lm (4000K)	1335 Lm (4000K)	369,80 B



NOIR MAT

BLANC MAT



### CAPRI S 1 P

DANS LA MÊME GAMME  
PAGE 254

## CAPRI S 2 C

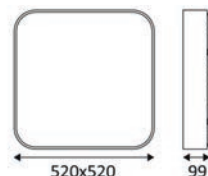
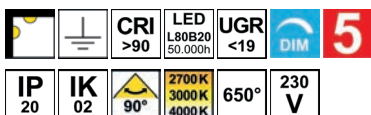

- Applique murale ou plafonnier.
- Diffuseur PS à structure prismatique.
- 2700K, 3000K ou 4000K au choix via un interrupteur dans le luminaire.
- Convertisseur dimmable coupure de phase ou dimmable DALI-push intégré dans l'appareil.

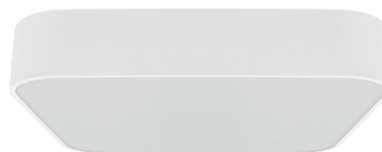

CAPRI S 2 C	MATIÈRE	LED	T°	LED Lumen	System Lumen	€
<b>DIMMABLE COUPURE DE PHASE</b>						
WA24305	NOIR MAT	ALUMINIUM	42W 2700-3000-4000K	5150 Lm (4000K)	3175 Lm (4000K)	399,60 B
WA24330	BLANC MAT	ALUMINIUM	42W 2700-3000-4000K	5150 Lm (4000K)	3175 Lm (4000K)	399,60 B
<b>DIMMABLE DALI</b>						
WA24305DA	NOIR MAT	ALUMINIUM	42W 2700-3000-4000K	5150 Lm (4000K)	3175 Lm (4000K)	540,80 B
WA24330DA	BLANC MAT	ALUMINIUM	42W 2700-3000-4000K	5150 Lm (4000K)	3175 Lm (4000K)	540,80 B



NOIR MAT

BLANC MAT



### CAPRI S 2 P

DANS LA MÊME GAMME  
PAGE 254



## RODA C

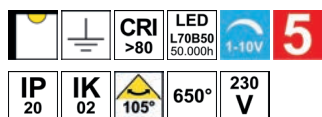

- Plafonnier linéaire.
- Diffuseur en polycarbonate.
- Livré avec câble d'alimentation noir ou blanc.
- Convertisseur dimmable inclus dans le profil.
- Compatible avec variateur 1-10V.

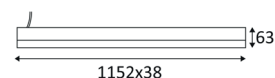
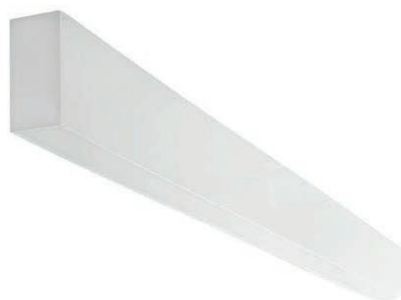

RODA C		MATIÈRE	LED	T°	LED Lumen	System Lumen	€
WA177WW05	■ NOIR MAT	ALUMINIUM	18W	3000K	2300 Lm	1900 Lm	222,50 B
WA177WW30	■ BLANC MAT	ALUMINIUM	18W	3000K	2300 Lm	1900 Lm	222,50 B
WA177NW05	■ NOIR MAT	ALUMINIUM	18W	4000K	2500 Lm	2000 Lm	222,50 B
WA177NW30	■ BLANC MAT	ALUMINIUM	18W	4000K	2500 Lm	2000 Lm	222,50 B



NOIR MAT



BLANC MAT



### RODA P

DANS LA MÊME GAMME  
PAGE 256

## SULLY C

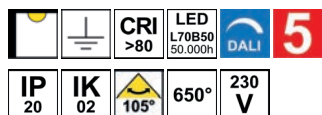

- Plafonnier linéaire.
- Diffuseur en polycarbonate.
- Livré avec câble d'alimentation noir ou blanc.
- Convertisseur dimmable DALI inclus dans le profil.

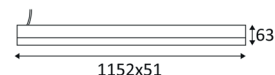

SULLY C		MATIÈRE	LED	T°	LED Lumen	System Lumen	€
WA178WW05	■ NOIR MAT	ALUMINIUM	26W	3000K	3500 Lm	2850 Lm	404,80 B
WA178WW30	■ BLANC MAT	ALUMINIUM	26W	3000K	3500 Lm	2850 Lm	404,80 B
WA178NW05	■ NOIR MAT	ALUMINIUM	26W	4000K	3700 Lm	3000 Lm	404,80 B
WA178NW30	■ BLANC MAT	ALUMINIUM	26W	4000K	3700 Lm	3000 Lm	404,80 B

ACCESSOIRES	DESCRIPTION	L (mm)	€
CD127	DALI PCU GESTION ECLAIRAGE	48	251,30 B



NOIR MAT



BLANC MAT



### SULLY P

DANS LA MÊME GAMME  
PAGE 256



## TOMY 1 C

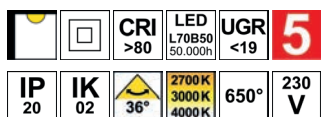

- Plafonnier linéaire.
- Réflecteur basse luminance.
- 2700K, 3000K ou 4000K au choix via un interrupteur à l'arrière du luminaire.
- Livré avec câble d'alimentation noir ou blanc.
- Convertisseur non dimmable intégré dans l'appareil.



TOMY 1 C		MATIÈRE	LED	T°	LED Lumen	System Lumen	€
WA22405	NOIR MAT	ALUMINIUM	36W	2700-3000-4000K	4100 Lm (4000K)	2835 Lm (4000K)	194,70 B
WA22430	BLANC MAT	ALUMINIUM	36W	2700-3000-4000K	4100 Lm (4000K)	2835 Lm (4000K)	194,70 B



NOIR MAT

BLANC MAT



**TOMY 1 P**

DANS LA MÊME GAMME  
PAGE 258



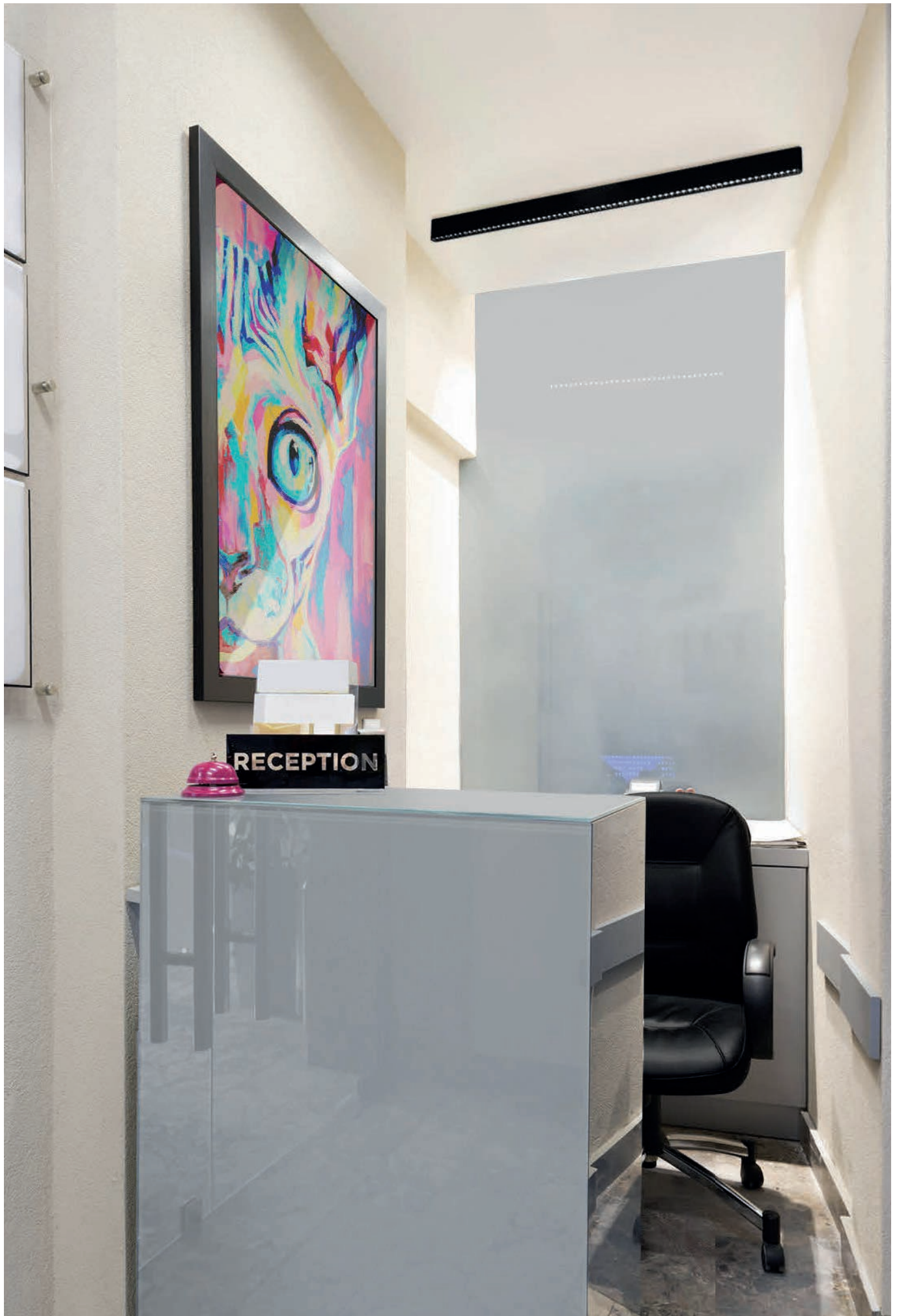

# INDIGO

LIGHTING





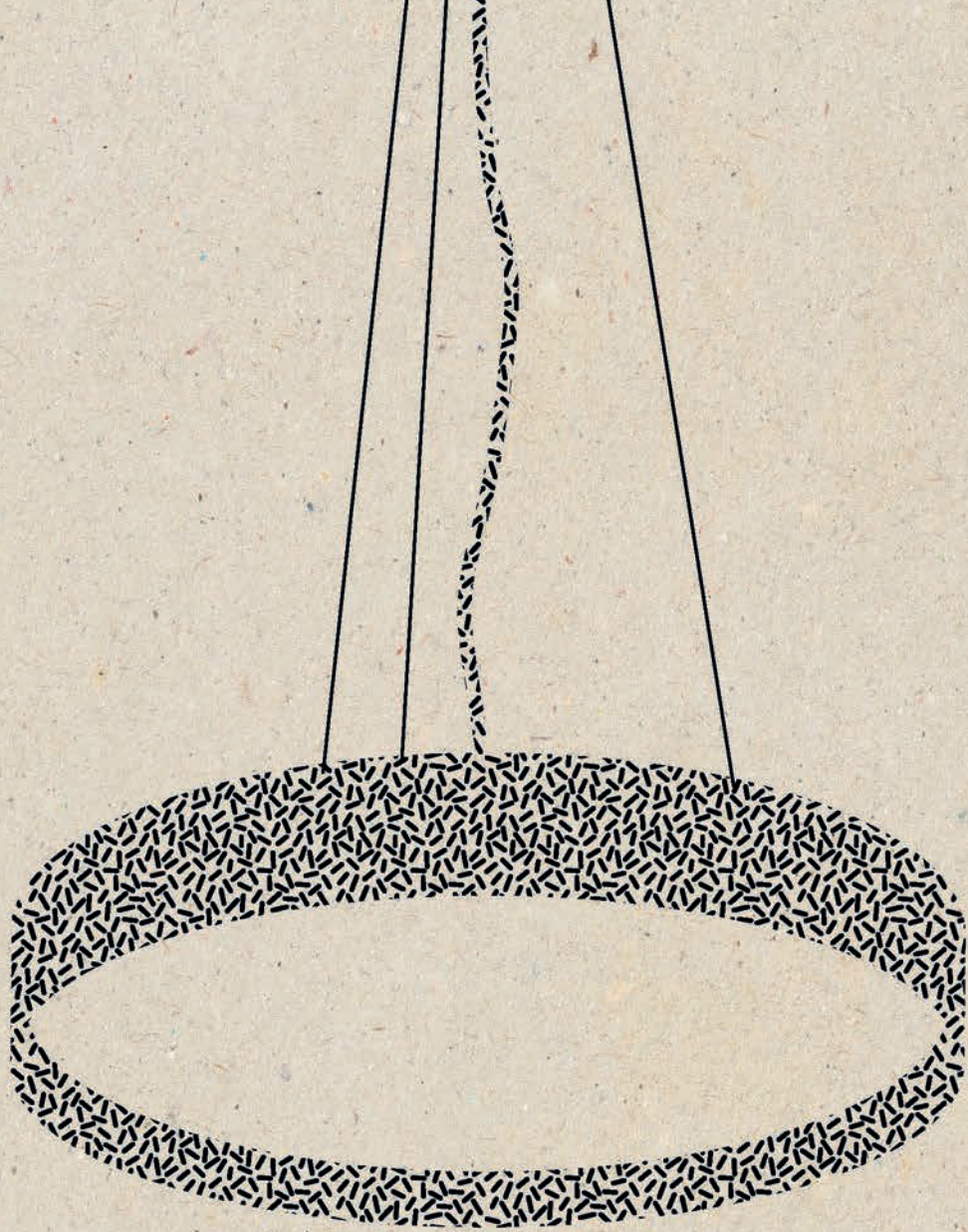

## **SUSPENSIONS**

## OKTO P GU10

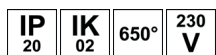

- Suspension décorative.
- Livrée avec câble d'alimentation textile (réglable 1.50m max).
- Coloris 05 - 08 - 06 - 83 : câble noir.
- Coloris 30 - 49 - 02 - 82 : câble blanc.



OKTO P GU10		MATIÈRE	SOCKET	LAMP	Watt Max	€
SU16005		NOIR MAT	ALUMINIUM	GU10	PAR16 LED	10W 74,20 B
SU16008		NOIR MAT - CHAMPAGNE	ALUMINIUM	GU10	PAR16 LED	10W 80,30 B
SU16006		NOIR MAT - OR ROSE	ALUMINIUM	GU10	PAR16 LED	10W 80,30 B
SU16083		NOIR MAT - ROSE	ALUMINIUM	GU10	PAR16 LED	10W 86,50 B
SU16030		BLANC MAT	ALUMINIUM	GU10	PAR16 LED	10W 74,20 B
SU16049		BLANC MAT - CHAMPAGNE	ALUMINIUM	GU10	PAR16 LED	10W 80,30 B
SU16002		BLANC MAT - OR ROSE	ALUMINIUM	GU10	PAR16 LED	10W 80,30 B
SU16082		BLANC MAT - ROSE	ALUMINIUM	GU10	PAR16 LED	10W 86,50 B





## ZEP 400 E27

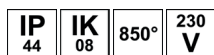

- Structure suspendue type "cloche".
- Diffuseur en polycarbonate. Ecran de sécurité inclus.
- Kit de suspension (réglable 2.00m max) et câble d'alimentation à commander séparément.

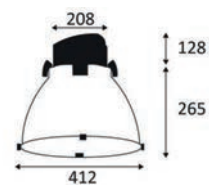

ZEP 400 E27		MATIÈRE	SOCKET	LAMP	Watt Max	€
SU13826	METAL - TRANSLUCIDE	COMPOSITE	E27	HE/FBT	100W/23W	227,60 B
SU13827	METAL - METAL	COMPOSITE	E27	HE/FBT	100W/23W	249,30 B
SU13833	NOIR - TRANSLUCIDE	COMPOSITE	E27	HE/FBT	100W/23W	196,70 B
SU13838	NOIR - METAL	COMPOSITE	E27	HE/FBT	100W/23W	222,50 B

ACCESSOIRES		DESCRIPTION	€
SU13976	TRANSLUCIDE	ZEP 400 E27 KIT DE SUSPENSION 2m	29,90 B





## AUREA P

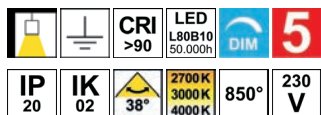

- Suspension décorative.
- Livrée avec câble d'alimentation (réglable 2.00m max).  
Coloris 05 - 08 - 83 : câble noir.  
Coloris 30 - 49 - 82 : câble blanc.
- 2700K, 3000K ou 4000K au choix via un interrupteur à l'arrière du luminaire.
- Convertisseur dimmable intégré dans l'appareil.
- Compatible avec variateur début de phase.



AUREA P		MATIÈRE	LED	T°	LED Lumen	System Lumen	€		
SU16905		NOIR MAT	ALUMINIUM	6W	2700-3000-4000K	715 Lm (4000K)	550 Lm (4000K)	144,20	B
SU16908		NOIR MAT - CHAMPAGNE	ALUMINIUM	6W	2700-3000-4000K	715 Lm (4000K)	550 Lm (4000K)	147,30	B
SU16983		NOIR MAT - ROSE	ALUMINIUM	6W	2700-3000-4000K	715 Lm (4000K)	550 Lm (4000K)	147,30	B
SU16930		BLANC MAT	ALUMINIUM	6W	2700-3000-4000K	715 Lm (4000K)	550 Lm (4000K)	144,20	B
SU16949		BLANC MAT - CHAMPAGNE	ALUMINIUM	6W	2700-3000-4000K	715 Lm (4000K)	550 Lm (4000K)	147,30	B
SU16982		BLANC MAT - ROSE	ALUMINIUM	6W	2700-3000-4000K	715 Lm (4000K)	550 Lm (4000K)	147,30	B

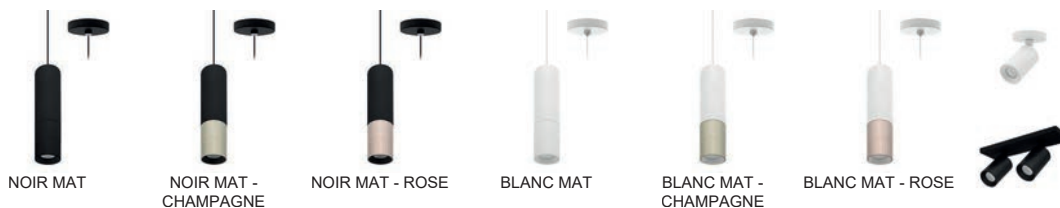

### AUREA 1 C

DANS LA MÊME GAMME  
PAGE 219

### AUREA 2 C

DANS LA MÊME GAMME  
PAGE 219





## JACK 3 P

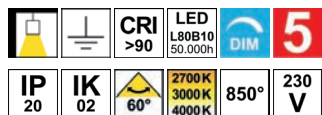

- Suspension décorative.
- Livrée avec câble d'alimentation textile (réglable 1.60m max).  
Coloris 05 - 13 - 06 : câble noir.  
Coloris 30 - 28 - 02 : câble blanc.
- 2700K, 3000K ou 4000K au choix via un interrupteur à l'arrière du luminaire.
- Convertisseur dimmable intégré dans l'appareil.
- Compatible avec variateur fin de phase.



JACK 3 P		MATIÈRE	LED	T°	LED Lumen	System Lumen	€		
SU16105		NOIR MAT	ALUMINIUM	25W	2700-3000-4000K	2810 Lm (4000K)	2270 Lm (4000K)	218,40	B
SU16113		NOIR MAT - LAITON	ALUMINIUM	25W	2700-3000-4000K	2810 Lm (4000K)	2270 Lm (4000K)	242,10	B
SU16106		NOIR MAT - OR ROSE	ALUMINIUM	25W	2700-3000-4000K	2810 Lm (4000K)	2270 Lm (4000K)	242,10	B
SU16130		BLANC MAT	ALUMINIUM	25W	2700-3000-4000K	2810 Lm (4000K)	2270 Lm (4000K)	218,40	B
SU16128		BLANC MAT - LAITON	ALUMINIUM	25W	2700-3000-4000K	2810 Lm (4000K)	2270 Lm (4000K)	242,10	B
SU16102		BLANC MAT - OR ROSE	ALUMINIUM	25W	2700-3000-4000K	2810 Lm (4000K)	2270 Lm (4000K)	242,10	B



## HELLO 1 P

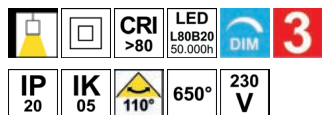

- Suspension décorative.
- Diffuseur en PMMA.
- Livrée avec câble d'alimentation textile noir ou blanc (réglable 2.00m max).
- Convertisseur dimmable intégré dans la base.
- Compatible avec variateur début et fin de phase.



HELLO 1 P	MATIÈRE	LED	T°	LED Lumen	System Lumen	€
SU166WW05	■ NOIR MAT ALUMINIUM	11W	3000K	1300 Lm	1070 Lm	133,90 B
SU166WW30	■ BLANC MAT ALUMINIUM	11W	3000K	1300 Lm	1070 Lm	133,90 B



## HELLO 2 P

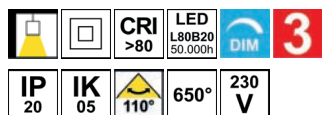

- Suspension décorative.
- Diffuseur en PMMA.
- Livrée avec câble d'alimentation textile noir ou blanc (réglable 2.00m max).
- Convertisseur dimmable intégré dans la base.
- Compatible avec variateur début et fin de phase.



HELLO 2 P	MATIÈRE	LED	T°	LED Lumen	System Lumen	€
SU167WW05	■ NOIR MAT ALUMINIUM	18W	3000K	2160 Lm	1835 Lm	177,20 B
SU167WW30	■ BLANC MAT ALUMINIUM	18W	3000K	2160 Lm	1835 Lm	177,20 B







## JUNE 1 P

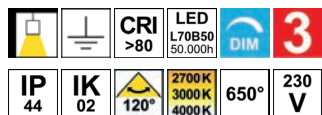

- Suspension décorative.
- Diffuseur en PS opalin.
- 2700K, 3000K ou 4000K au choix via un interrupteur dans le luminaire.
- Livrée avec câbles de suspension blancs ou noirs (réglables 1.50m max), base ronde et câble d'alimentation blancs ou noirs.
- Convertisseur dimmable intégré dans l'appareil.
- Compatible avec variateur début et fin de phase.

JUNE 1 P		MATIÈRE	LED	T°	LED Lumen	System Lumen	€
SU15605	■ NOIR MAT	ALUMINIUM	18W	2700-3000-4000K	3300 Lm (4000K)	1775 Lm (4000K)	129,80 B
SU15630	■ BLANC MAT	ALUMINIUM	18W	2700-3000-4000K	3300 Lm (4000K)	1775 Lm (4000K)	129,80 B



NOIR MAT

BLANC MAT

### JUNE 1 C

DANS LA MÊME GAMME  
PAGE 226





## JUNE 2 P

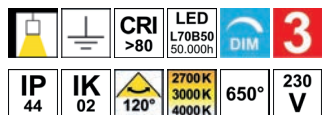

- Suspension décorative.
- Diffuseur en PS opalin.
- 2700K, 3000K ou 4000K au choix via un interrupteur dans le luminaire.
- Livrée avec câbles de suspension blancs ou noirs (réglables 1.50m max), base ronde et câble d'alimentation blancs ou noirs.
- Convertisseur dimmable intégré dans l'appareil.
- Compatible avec variateur début et fin de phase.



JUNE 2 P	MATIÈRE	LED	T°	LED Lumen	System Lumen	€
SU15705	NOIR MAT	ALUMINIUM	30W	2700-3000-4000K	5600 Lm (4000K)	3325 Lm (4000K) 189,50 B
SU15730	BLANC MAT	ALUMINIUM	30W	2700-3000-4000K	5600 Lm (4000K)	3325 Lm (4000K) 189,50 B



NOIR MAT

BLANC MAT

### JUNE 2 C

DANS LA MÊME GAMME  
PAGE 227

## JUNE 3 P

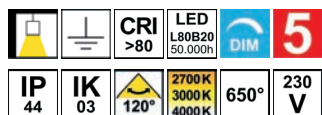

- Suspension décorative.
- Diffuseur en PS opalin.
- 2700K, 3000K ou 4000K au choix via un interrupteur dans le luminaire.
- Livrée avec câbles de suspension blancs ou noirs (réglables 1.50m max), base ronde et câble d'alimentation blancs ou noirs.
- Convertisseur dimmable intégré dans l'appareil.
- Compatible avec variateur début et fin de phase.



JUNE 3 P	MATIÈRE	LED	T°	LED Lumen	System Lumen	€
SU16305	NOIR MAT	ALUMINIUM	50W	2700-3000-4000K	8000 Lm (4000K)	5920 Lm (4000K) 318,30 B
SU16330	BLANC MAT	ALUMINIUM	50W	2700-3000-4000K	8000 Lm (4000K)	5920 Lm (4000K) 318,30 B



NOIR MAT

BLANC MAT

### JUNE 3 C

DANS LA MÊME GAMME  
PAGE 227

NEW

## NOVA CSP 1 P

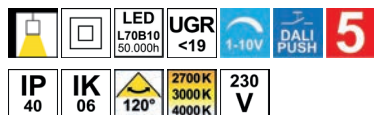

- Suspension ronde.
- Diffuseur microprismatique.
- 2700K, 3000K ou 4000K au choix via un interrupteur dans le luminaire.
- Livrée avec câbles de suspension en acier (réglables 2.00m max), base ronde et câble d'alimentation blancs ou noirs.
- Convertisseur dimmable DALI, Push-Dim et 1-10V intégré dans l'appareil.
- Kit d'éclairage indirect non-dimmable en option.



NOVA CSP 1 P		MATIÈRE	LED	T°	LED Lumen	System Lumen	€
SU17036	NEW	NOIR MAT - DORÉ	ALUMINIUM	26W	2700-3000-4000K	3930 Lm (4000K)	3000 Lm (4000K) 603,80 A
SU17080	NEW	BLANC MAT - DORÉ	ALUMINIUM	26W	2700-3000-4000K	3930 Lm (4000K)	3000 Lm (4000K) 666,50 A

ACCESSOIRES	MATIÈRE	DESCRIPTION	€		NOVA CSP 1 C
NV45UPM	NEW	POLYCARBONATE	KIT UPLIGHT NOVA 1 13W 3000K 1100Lm	122,60 A	DANS LA MÊME GAMME PAGE 228



NOIR MAT - DORÉ BLANC MAT - DORÉ

NEW

## NOVA CSP 2 P

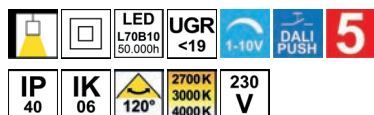

- Suspension ronde.
- Diffuseur microprismatique.
- 2700K, 3000K ou 4000K au choix via un interrupteur dans le luminaire.
- Livrée avec câbles de suspension en acier (réglables 2.00m max), base ronde et câble d'alimentation blancs ou noirs.
- Convertisseur dimmable DALI, Push-Dim et 1-10V intégré dans l'appareil.
- Kit d'éclairage indirect non-dimmable en option.



NOVA CSP 2 P		MATIÈRE	LED	T°	LED Lumen	System Lumen	€
SU17136	NEW	NOIR MAT - DORÉ	ALUMINIUM	40W	2700-3000-4000K	6075 Lm (4000K)	4800 Lm (4000K) 802,50 A
SU17180	NEW	BLANC MAT - DORÉ	ALUMINIUM	40W	2700-3000-4000K	6075 Lm (4000K)	4800 Lm (4000K) 865,20 A

ACCESSOIRES	MATIÈRE	DESCRIPTION	€		NOVA CSP 2 C
NV60UPM	NEW	POLYCARBONATE	KIT UPLIGHT NOVA 2 20W 3000K 1700Lm	178,90 A	DANS LA MÊME GAMME PAGE 228



NOIR MAT - DORÉ BLANC MAT - DORÉ



## NOVA CSP 3 P

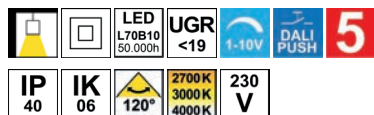

collingwood

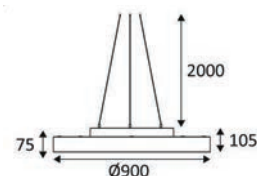

NEW

- Suspension ronde.
- Diffuseur micropismatique.
- 2700K, 3000K ou 4000K au choix via un interrupteur dans le luminaire.
- Livrée avec câbles de suspension en acier (réglables 2.00m max), base ronde et câble d'alimentation blancs ou noirs.
- Convertisseur dimmable DALI, Push-Dim et 1-10V intégré dans l'appareil.
- Kit d'éclairage indirect non-dimmable en option.



NOVA CSP 3 P		MATIÈRE	LED	T°	LED Lumen	System Lumen	€	
SU17236	<b>NEW</b>	NOIR MAT - DORÉ	ALUMINIUM	68W	2700-3000-4000K	10740 Lm (4000K)	9000 Lm (4000K)	1.558,30 A
SU17280	<b>NEW</b>	BLANC MAT - DORÉ	ALUMINIUM	68W	2700-3000-4000K	10740 Lm (4000K)	9000 Lm (4000K)	1.621,10 A

ACCESSOIRES	MATIÈRE	DESCRIPTION	€		NOVA CSP 3 C
NV90UPM	<b>NEW</b> POLYCARBONATE	KIT UPLIGHT NOVA 3 28W 3000K 2400Lm	271,60 A		DANS LA MÊME GAMME PAGE 229



NOIR MAT - DORÉ BLANC MAT - DORÉ



## CAPRI R 1 P

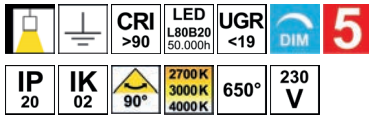

- Suspension ronde.
- Diffuseur PS à structure prismatique.
- 2700K, 3000K ou 4000K au choix via un interrupteur dans le luminaire.
- Livrée avec câbles de suspension en acier (réglables 2.00m max), base ronde et câble d'alimentation blancs ou noirs.
- Convertisseur dimmable coupure de phase ou dimmable DALI-push intégré dans l'appareil.



CAPRI R 1 P	MATIÈRE	LED	T°	LED Lumen	System Lumen	€
<b>DIMMABLE COUPURE DE PHASE</b>						
SU15305	NOIR MAT	ALUMINIUM	20W	2700-3000-4000K	2400 Lm (4000K)	1360 Lm (4000K) <b>287,40</b> B
SU15330	BLANC MAT	ALUMINIUM	20W	2700-3000-4000K	2400 Lm (4000K)	1360 Lm (4000K) <b>287,40</b> B
<b>DIMMABLE DALI</b>						
SU15305DA	NOIR MAT	ALUMINIUM	20W	2700-3000-4000K	2400 Lm (4000K)	1360 Lm (4000K) <b>451,10</b> B
SU15330DA	BLANC MAT	ALUMINIUM	20W	2700-3000-4000K	2400 Lm (4000K)	1360 Lm (4000K) <b>451,10</b> B



NOIR MAT

BLANC MAT

### CAPRI R 1 C

DANS LA MÊME GAMME  
PAGE 230

## CAPRI R 2 P

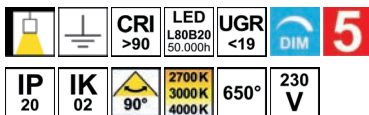

- Suspension ronde.
- Diffuseur PS à structure prismatique.
- 2700K, 3000K ou 4000K au choix via un interrupteur dans le luminaire.
- Livrée avec câbles de suspension en acier (réglables 2.00m max), base ronde et câble d'alimentation blancs ou noirs.
- Convertisseur dimmable coupure de phase ou dimmable DALI-push intégré dans l'appareil.

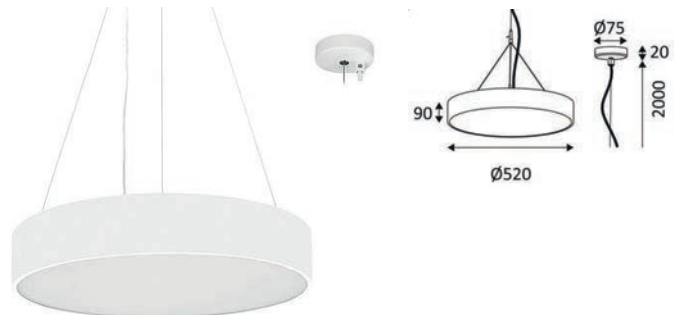

CAPRI R 2 P	MATIÈRE	LED	T°	LED Lumen	System Lumen	€
<b>DIMMABLE COUPURE DE PHASE</b>						
SU15405	NOIR MAT	ALUMINIUM	42W	2700-3000-4000K	5150 Lm (4000K)	2910 Lm (4000K) <b>420,20</b> B
SU15430	BLANC MAT	ALUMINIUM	42W	2700-3000-4000K	5150 Lm (4000K)	2910 Lm (4000K) <b>420,20</b> B
<b>DIMMABLE DALI</b>						
SU15405DA	NOIR MAT	ALUMINIUM	42W	2700-3000-4000K	5150 Lm (4000K)	2910 Lm (4000K) <b>606,70</b> B
SU15430DA	BLANC MAT	ALUMINIUM	42W	2700-3000-4000K	5150 Lm (4000K)	2910 Lm (4000K) <b>606,70</b> B



NOIR MAT

BLANC MAT

### CAPRI R 2 C

DANS LA MÊME GAMME  
PAGE 231



## CAPRI R 3 P

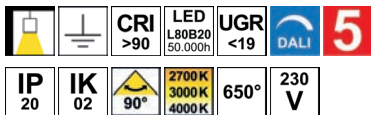

- Suspension ronde.
- Diffuseur PS à structure prismatique.
- 2700K, 3000K ou 4000K au choix via un interrupteur dans le luminaire.
- Livrée avec câbles de suspension en acier (réglables 2.00m max), base ronde et câble d'alimentation blancs ou noirs.
- Convertisseur dimmable DALI intégré dans l'appareil.

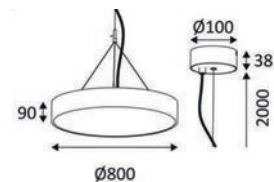

CAPRI R 3 P	MATIÈRE	LED	T°	LED Lumen	System Lumen	€
SU15505DA	NOIR MAT	ALUMINIUM	105W	2700-3000-4000K	11800 Lm (4000K)	7070 Lm (4000K) 1.190,70 B
SU15530DA	BLANC MAT	ALUMINIUM	105W	2700-3000-4000K	11800 Lm (4000K)	7070 Lm (4000K) 1.190,70 B

ACCESSOIRES	DESCRIPTION	L (mm)	€	CAPRI R 3 C
CD127	DALI PCU GESTION ECLAIRAGE	48	251,30 B	DANS LA MÊME GAMME PAGE 231



NOIR MAT

BLANC MAT



## CAPRI S 1 P

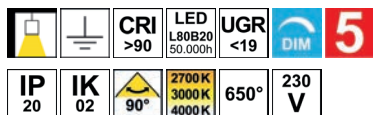

- Suspension carrée.
- Diffuseur PS à structure prismatique.
- 2700K, 3000K ou 4000K au choix via un interrupteur dans le luminaire.
- Livrée avec câbles de suspension en acier (réglables 2.00m max), base ronde et câble d'alimentation blancs ou noirs.
- Convertisseur dimmable coupure de phase ou dimmable DALI-push intégré dans l'appareil.

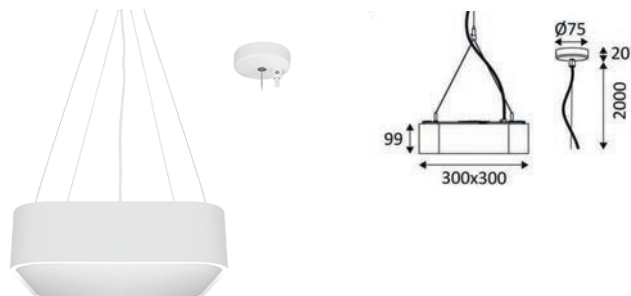

CAPRI S 1 P	MATIÈRE	LED	T°	LED Lumen	System Lumen	€
<b>DIMMABLE COUPURE DE PHASE</b>						
<b>SU16405</b>	■ NOIR MAT	ALUMINIUM	20W	2700-3000-4000K	2400 Lm (4000K)	1335 Lm (4000K) <b>326,50</b> B
<b>SU16430</b>	■ BLANC MAT	ALUMINIUM	20W	2700-3000-4000K	2400 Lm (4000K)	1335 Lm (4000K) <b>326,50</b> B
<b>DIMMABLE DALI</b>						
<b>SU16405DA</b>	■ NOIR MAT	ALUMINIUM	20W	2700-3000-4000K	2400 Lm (4000K)	1335 Lm (4000K) <b>506,80</b> B
<b>SU16430DA</b>	■ BLANC MAT	ALUMINIUM	20W	2700-3000-4000K	2400 Lm (4000K)	1335 Lm (4000K) <b>506,80</b> B



NOIR MAT

BLANC MAT

### CAPRI S 1 C

DANS LA MÊME GAMME  
PAGE 232

## CAPRI S 2 P

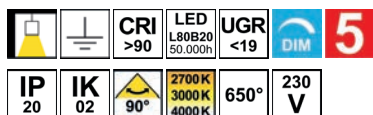

- Suspension carrée.
- Diffuseur PS à structure prismatique.
- 2700K, 3000K ou 4000K au choix via un interrupteur dans le luminaire.
- Livrée avec câbles de suspension en acier (réglables 2.00m max), base ronde et câble d'alimentation blancs ou noirs.
- Convertisseur dimmable coupure de phase ou dimmable DALI-push intégré dans l'appareil.

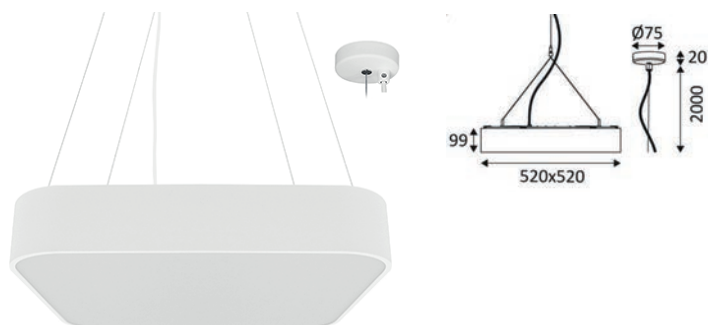

CAPRI S 2 P	MATIÈRE	LED	T°	LED Lumen	System Lumen	€
<b>DIMMABLE COUPURE DE PHASE</b>						
<b>SU16505</b>	■ NOIR MAT	ALUMINIUM	42W	2700-3000-4000K	5150 Lm (4000K)	3175 Lm (4000K) <b>470,70</b> B
<b>SU16530</b>	■ BLANC MAT	ALUMINIUM	42W	2700-3000-4000K	5150 Lm (4000K)	3175 Lm (4000K) <b>470,70</b> B
<b>DIMMABLE DALI</b>						
<b>SU16505DA</b>	■ NOIR MAT	ALUMINIUM	42W	2700-3000-4000K	5150 Lm (4000K)	3175 Lm (4000K) <b>677,70</b> B
<b>SU16530DA</b>	■ BLANC MAT	ALUMINIUM	42W	2700-3000-4000K	5150 Lm (4000K)	3175 Lm (4000K) <b>677,70</b> B



NOIR MAT

BLANC MAT

### CAPRI S 2 C

DANS LA MÊME GAMME  
PAGE 232





## RODA P

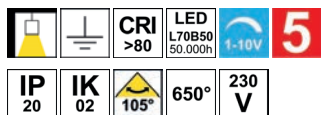

- Suspension linéaire.
- Diffuseur en polycarbonate.
- Livrée avec câbles de suspension en acier (réglables 2.00m max), base carrée et câble d'alimentation blancs ou noirs.
- Convertisseur dimmable inclus dans le profil.
- Compatible avec variateur 1-10V.

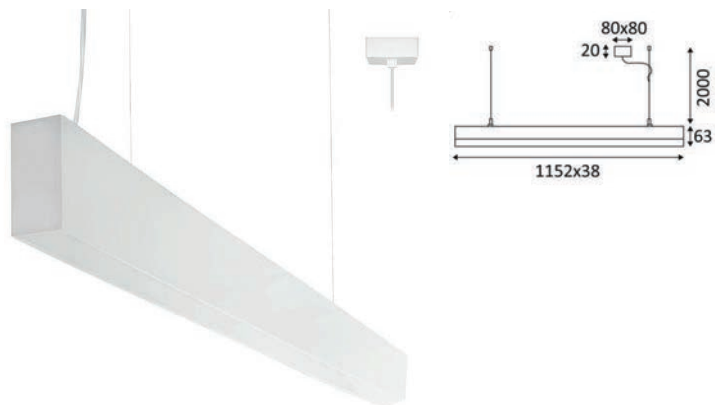

RODA P	MATIÈRE	LED	T°	LED Lumen	System Lumen	€	
SU148WW05	NOIR MAT	ALUMINIUM	18W	3000K	2300 Lm	1900 Lm	273,00 B
SU148WW30	BLANC MAT	ALUMINIUM	18W	3000K	2300 Lm	1900 Lm	273,00 B
SU148NW05	NOIR MAT	ALUMINIUM	18W	4000K	2500 Lm	2000 Lm	273,00 B
SU148NW30	BLANC MAT	ALUMINIUM	18W	4000K	2500 Lm	2000 Lm	273,00 B



### RODA C

DANS LA MÊME GAMME  
PAGE 234

## SULLY P

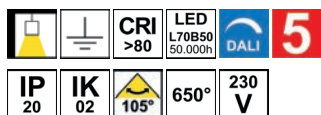

- Suspension linéaire.
- Diffuseur en polycarbonate.
- Livrée avec câbles de suspension en acier (réglables 2.00m max), base carrée et câble d'alimentation blancs ou noirs.
- Convertisseur dimmable DALI inclus dans le profil.

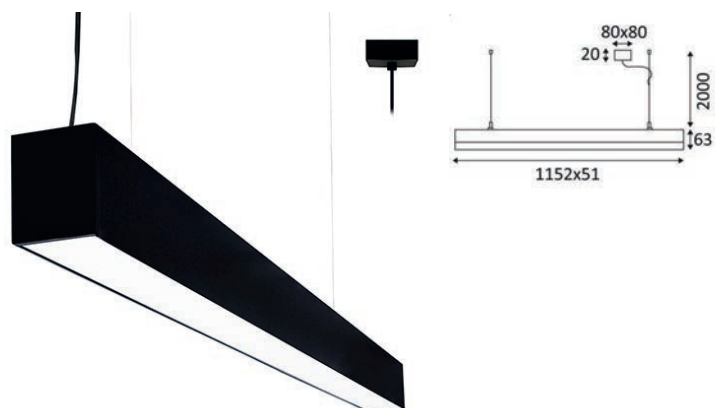

SULLY P	MATIÈRE	LED	T°	LED Lumen	System Lumen	€	
SU149WW05	NOIR MAT	ALUMINIUM	26W	3000K	3500 Lm	2850 Lm	455,30 B
SU149WW30	BLANC MAT	ALUMINIUM	26W	3000K	3500 Lm	2850 Lm	459,40 B
SU149NW05	NOIR MAT	ALUMINIUM	26W	4000K	3700 Lm	3000 Lm	455,30 B
SU149NW30	BLANC MAT	ALUMINIUM	26W	4000K	3700 Lm	3000 Lm	459,40 B

ACCESSOIRES	DESCRIPTION	L (mm)	€
CD127	DALI PCU GESTION ECLAIRAGE	48	251,30 B

### SULLY C

DANS LA MÊME GAMME  
PAGE 234





## TOMY 1 P

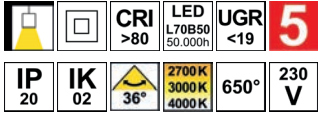

- Suspension linéaire.
- Réflecteur basse luminance.
- 2700K, 3000K ou 4000K au choix via un interrupteur à l'arrière du luminaire.
- Livrée avec câbles de suspension blancs ou noirs (réglables 2.00m max), base ronde et câble d'alimentation blancs ou noirs.
- Convertisseur non dimmable intégré dans l'appareil.

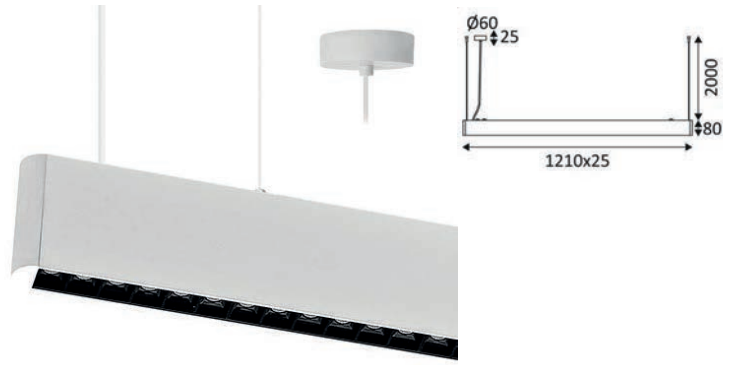

TOMY 1 P	MATIÈRE	LED	T°	LED Lumen	System Lumen	€	
SU15805	NOIR MAT	ALUMINIUM	36W	2700-3000-4000K	4100 Lm (4000K)	2835 Lm (4000K)	197,80 B
SU15830	BLANC MAT	ALUMINIUM	36W	2700-3000-4000K	4100 Lm (4000K)	2835 Lm (4000K)	197,80 B



NOIR MAT

BLANC MAT

### TOMY 1 C

DANS LA MÊME GAMME  
PAGE 236

## TOMY 2 P

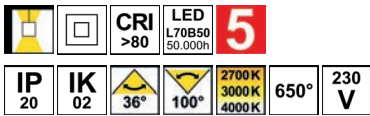

- Suspension linéaire.
- Eclairage "up", "down" ou "up&down" au choix via un interrupteur à l'arrière du luminaire.
- Réflecteur basse luminance (éclairage vers le bas) et diffuseur en polycarbonate (éclairage vers le haut).
- 2700K, 3000K ou 4000K au choix via un interrupteur à l'arrière du luminaire.
- Livrée avec câbles de suspension blancs ou noirs (réglables 2.00m max), base ronde et câble d'alimentation blancs ou noirs.
- Convertisseur non dimmable intégré dans l'appareil.

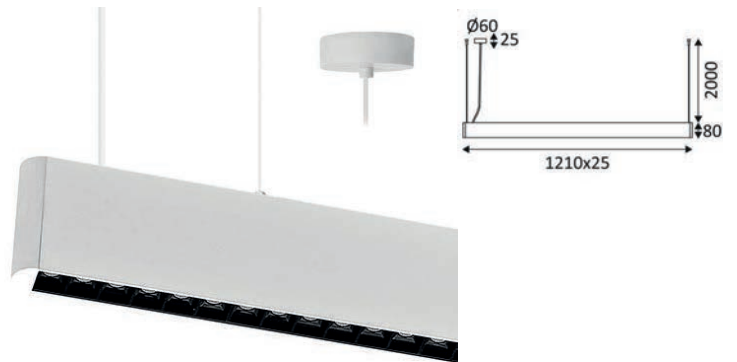

TOMY 2 P	MATIÈRE	LED	T°	LED Lumen	System Lumen	α	€	
SU15905	NOIR MAT	ALUMINIUM	2x36W	2700-3000-4000K	4100+3800 Lm (4000K)	2835+2430 Lm (4000K)	36° / 100°	277,10 B
SU15930	BLANC MAT	ALUMINIUM	2x36W	2700-3000-4000K	4100+3800 Lm (4000K)	2835+2430 Lm (4000K)	36° / 100°	277,10 B



NOIR MAT

BLANC MAT



## OTIS 2 P

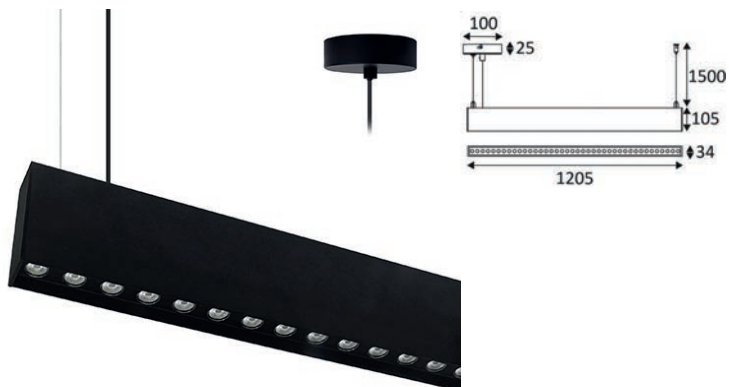
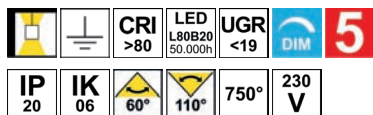

- Suspension linéaire.
- Eclairage "up", "down" ou "up&down" au choix via un interrupteur à l'arrière du luminaire.
- Réflecteur basse luminance (éclairage vers le bas) et diffuseur en polycarbonate (éclairage vers le haut).
- Livrée avec câbles de suspension blancs ou noirs (réglables 1.50m max), base ronde et câble d'alimentation blancs ou noirs.
- Convertisseur dimmable intégré dans l'appareil.
- Compatible avec variateur début et fin de phase.

OTIS 2 P	MATIÈRE	LED	T°	LED Lumen	System Lumen	α	€
SU168WW05	NOIR MAT	ALUMINIUM	3000K	3850+850 Lm	3525+645 Lm	60° / 110°	346,10 B
SU168WW30	BLANC MAT	ALUMINIUM	3000K	3850+850 Lm	3525+645 Lm	60° / 110°	346,10 B
SU168NW05	NOIR MAT	ALUMINIUM	4000K	4350+900 Lm	3870+590 Lm	60° / 110°	346,10 B
SU168NW30	BLANC MAT	ALUMINIUM	4000K	4350+900 Lm	3870+590 Lm	60° / 110°	346,10 B



NOIR MAT

BLANC MAT





# INDIGO

LIGHTING







## **BANDEAUX & PROFILS**

**Tableau de compatibilité : PROFILS & BANDEAUX LEDS**

	ST104	ST150	ST153	ST156	ST112	ST159	ST123	ST125	ST160	ST132
	5,4W/m	4,8W/m	9,6W/m	14,4W/m	14,4W/m	14,4W/m	14,4W/m	19,2W/m	22W/m	9,6W/m
PR115	V									
PR117	V	V	V					V	V	V
PR139	V	V	V							V
PR121			V	V	V	V	V			V
PR127	V									
PR130	V	V	V					V	V	V
PR146						V	V			
PR133		V	V							V
PR135		V	V							V
PR137				V	V	V	V	V	V	





**Tableau de compatibilité : CONVERTISSEURS & BANDEAUX LEDS**

BANDEAUX			CONVERTISSEURS														
			CD173	CD174	CD158	CD175	CD176	CD150	CD159	CD177	CD151	CD178	CD179	CD180	CD181	CD153	CD154
CODE	P	L max (m) ligne continue	30W	60W	60W	75W	120W	120W	150W	180W	200W	75W IP67	100W IP67	150W IP67	250W IP67	75W DIM	200W DIM
			<b>LONGUEUR MAXIMALE DE BANDEAUX PAR ALIMENTATION (m)</b>														
ST104	5,4W/m	10	5	10	10	12,5	20	20	25	30	33,3	12,5	16,6	25	41,6	12,5	33,3
ST150	4,8W/m	10	5,6	11,2	11,2	14	22,5	22,5	28,1	33,7	37,5	14	18,7	28,1	46,8	14	37,5
ST153	9,6W/m	10	2,8	5,6	5,6	7	11,2	11,2	14	16,8	18,7	7	9,3	14	23,4	7	18,7
ST156	14,4W/m	10	1,8	3,7	3,7	4,6	7,5	7,5	9,3	11,2	12,5	4,6	6,2	9,3	15,6	4,6	12,5
ST112	14,4W/m	10	1,8	3,7	3,7	4,6	7,5	7,5	9,3	11,2	12,5	4,6	6,2	9,3	15,6	4,6	12,5
ST159	14,4W/m	10	1,8	3,7	3,7	4,6	7,5	7,5	9,3	11,2	12,5	4,6	6,2	9,3	15,6	4,6	12,5
ST123	14,4W/m	10	1,8	3,7	3,7	4,6	7,5	7,5	9,3	11,2	12,5	4,6	6,2	9,3	15,6	4,6	12,5
ST125	19,2W/m	7	1,4	2,8	2,8	3,5	5,6	5,6	7	8,4	9,3	3,5	4,6	7	11,7	3,5	9,3
ST160	22W/m	6	1,2	2,4	2,4	3	4,9	4,9	6,1	7,3	8,1	3	4	6,1	10,2	3	8,1
ST132	9,6W/m	10	2,8	5,6	5,6	7	11,2	11,2	14	16,8	18,7	7	9,3	14	23,4	7	18,7
ST135	9,6W/m	10	2,8	5,6	5,6	7	11,2	11,2	14	16,8	18,7	7	9,3	14	23,4	7	18,7
ST135RGB	12W/m	10	2,2	4,5	4,5	5,6	9	9	11,2	13,5	15	5,6	7,5	11,2	18,8	5,6	15

**Tableau de compatibilité : CONTRÔLEURS & BANDEAUX LEDS**

BANDEAUX		CONTRÔLEURS					
		CD136	CD135	CD141	C100924	CD142	CD156
CODE	P (W/m)	Variateur	Contrôleur RGB	Contrôleur RGB+W	Contrôleur RGB+W	Contrôleur 2700-6000K	Contrôleur Bluetooth
ST104	5,4W/m	V					V
ST150	4,8W/m	V					V
ST153	9,6W/m	V					V
ST156	14,4W/m	V					V
ST112	14,4W/m		V	V	V		V
ST159	14,4W/m	v					V
ST123	14,4W/m		V	V	V		V
ST125	19,2W/m			V	V		V
ST160	22W/m	V					V
ST132	9,6W/m					V	V
ST135	9,6W/m	V					V
ST135RGB	12W/m		V	V	V		V

# ST104

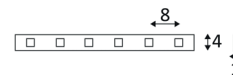

- Bandeau LED (SMD 2216).
- Rouleau 5m.
- Précâblé en début et fin de bandeau.
- Autocollant.
- Sécable toutes les 6 LEDs, 50mm.
- Convertisseur à commander séparément.

ST104	LED	T°	LED Lumen	L (mm)	€
ST104WW	5,4W/m	3000K	460 Lm/m	5000	80,30 B
ST104NW	5,4W/m	4000K	475 Lm/m	5000	80,30 B
ST104CW	5,4W/m	6000K	475 Lm/m	5000	80,30 B

## POUR UNE INSTALLATION MONOCHROME NON DIMMABLE

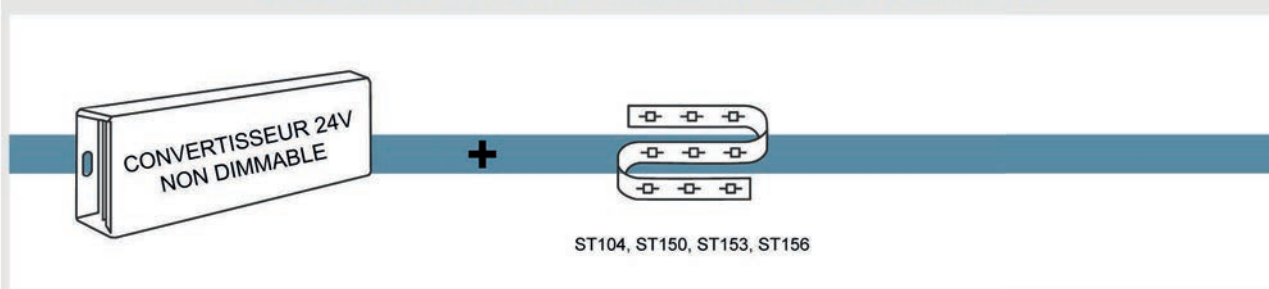

## POUR UNE INSTALLATION MONOCHROME DIMMABLE

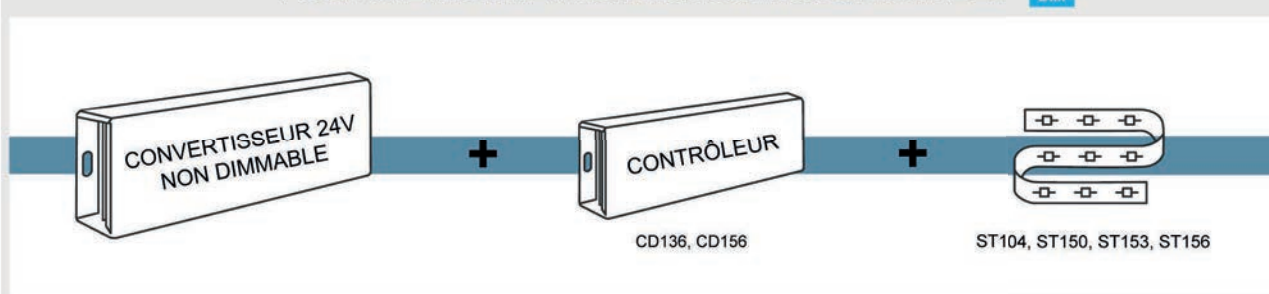

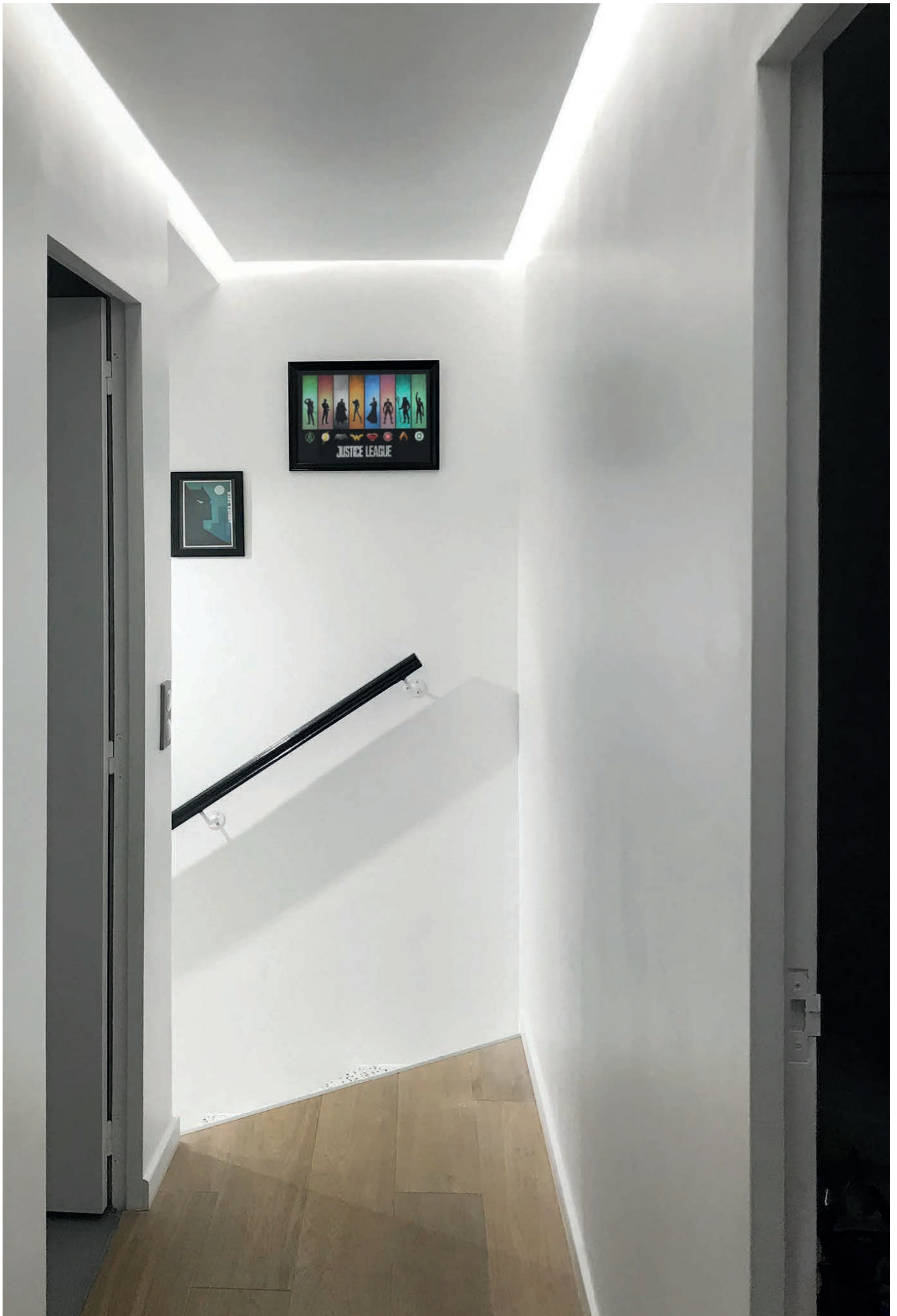

# ST150

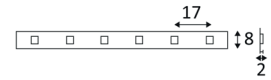



- Bandeau LED (SMD 2835).
- Rouleau 5m.
- Précâblé en début et fin de bandeau.
- Autocollant.
- Sécable toutes les 6 LEDs, 100mm.
- Convertisseur et accessoires à commander séparément.

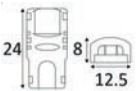

ST150	LED	T°	LED Lumen	L (mm)	€
ST150SW	4,8W/m	2700K	378 Lm/m	5000	59,70 B
ST150WW	4,8W/m	3000K	399 Lm/m	5000	59,70 B
ST150NW	4,8W/m	4000K	410 Lm/m	5000	59,70 B
ST150CW	4,8W/m	6000K	399 Lm/m	5000	59,70 B

**ACCESSOIRES** €

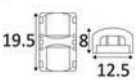
ST151	CONNECTEUR			11,30 B
ST152	INTERCONNECTEUR			11,30 B





# ST153

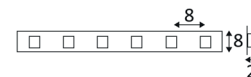
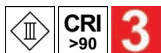



- Bandeau LED (SMD 2835).
- Rouleau 5m.
- Précâblé en début et fin de bandeau.
- Autocollant.
- Sécable toutes les 6 LEDs, 50mm.
- Convertisseur et accessoires à commander séparément.

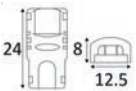

ST153	LED	T°	LED Lumen	L (mm)	€
ST153SW	9,6W/m	2700K	748 Lm/m	5000	84,50 B
ST153WW	9,6W/m	3000K	790 Lm/m	5000	84,50 B
ST153NW	9,6W/m	4000K	802 Lm/m	5000	84,50 B
ST153CW	9,6W/m	6000K	790 Lm/m	5000	84,50 B

**ACCESSOIRES** €

ST151	CONNECTEUR			11,30 B
-------	------------	---	---	---------

ST152	INTERCONNECTEUR			11,30 B
-------	-----------------	---	---	---------

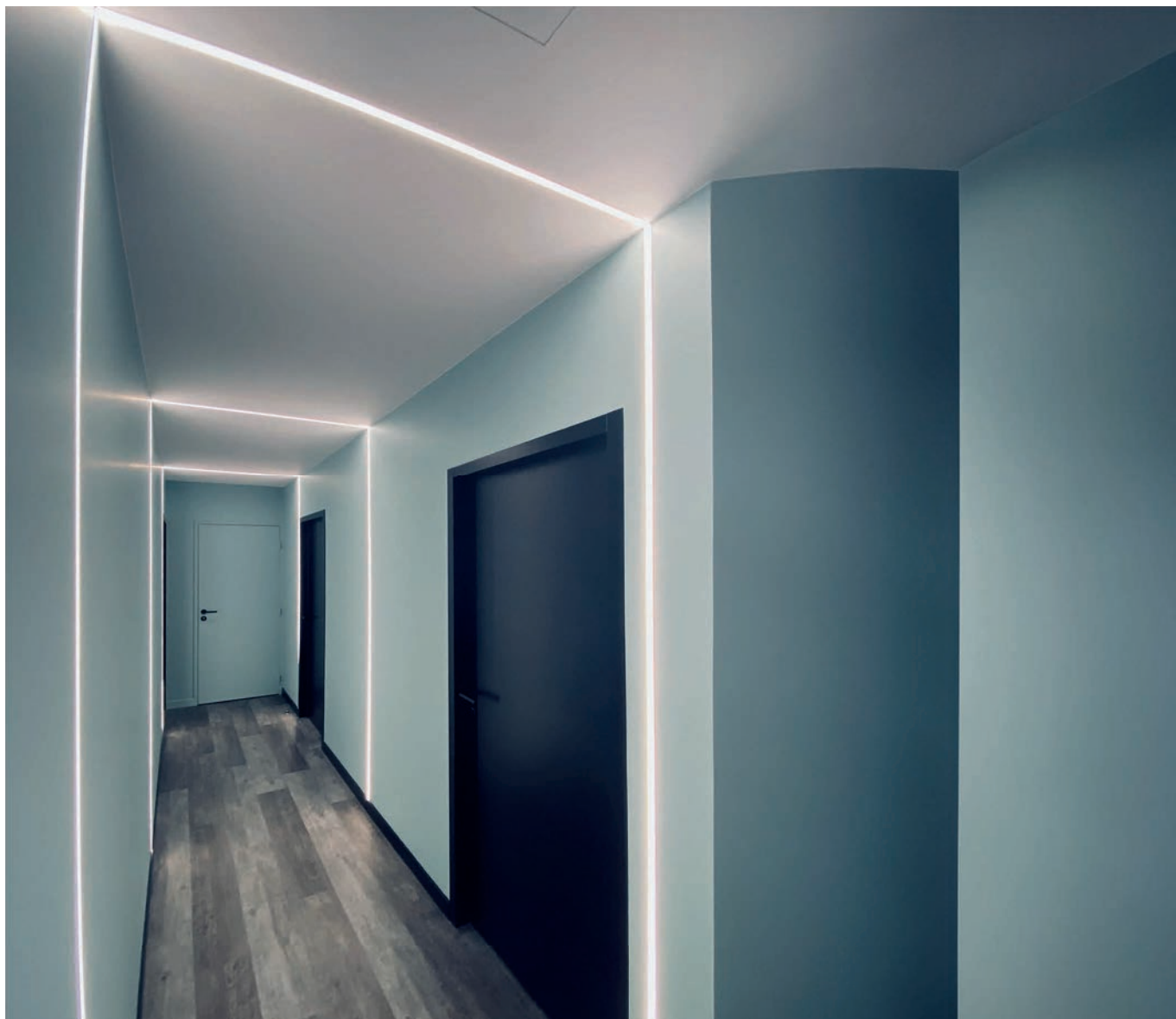

# ST156

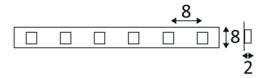



- Bandeau LED (SMD 2835).
- Rouleau 5m.
- Précâblé en début et fin de bandeau.
- Autocollant.
- Sécable toutes les 6 LEDs, 50mm.
- Convertisseur et accessoires à commander séparément.

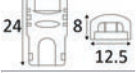

ST156	LED	T°	LED Lumen	L (mm)	€
ST156SW	14,4W/m	2700K	1200 Lm/m	5000	108,20 B
ST156WW	14,4W/m	3000K	1270 Lm/m	5000	108,20 B
ST156NW	14,4W/m	4000K	1318 Lm/m	5000	108,20 B
ST156CW	14,4W/m	6000K	1270 Lm/m	5000	108,20 B

**ACCESSOIRES** €

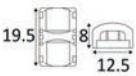
ST151	CONNECTEUR			11,30 B
ST152	INTERCONNECTEUR			11,30 B

## POUR UNE INSTALLATION MONOCHROME NON DIMMABLE

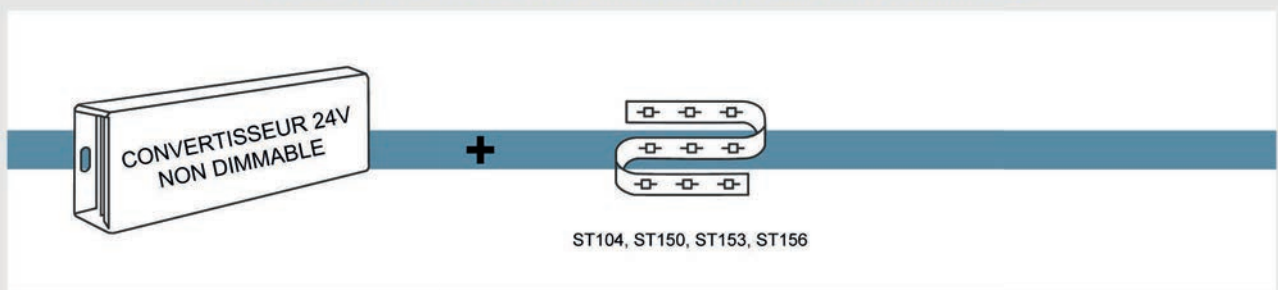

## POUR UNE INSTALLATION MONOCHROME DIMMABLE

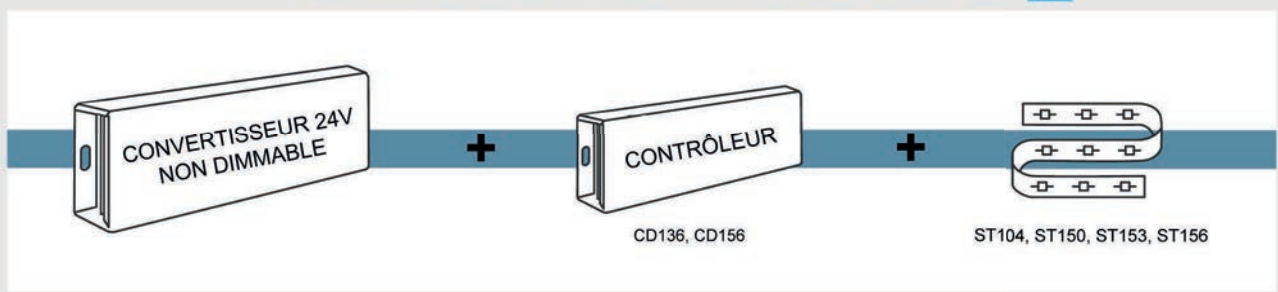





# ST112



3







- Bandeau LED RGB.
- Rouleau 5m.
- Précâblé en début et fin de bandeau.
- Autocollant.
- Sécable toutes les 6 LEDs, 100mm.
- Convertisseur, contrôleur et accessoires à commander séparément.



ST112	LED	T°	L (mm)	€
ST112RGB	14,4W/m	RGB	5000	117,40 B

### ACCESSOIRES

ST118	BLANC	CONNECTEUR RGB		3,10 B
ST119	BLANC	INTERCONNECTEUR RGB		2,10 B
ST120	BLANC	CONNECTEUR L RGB		6,20 B
ST121	BLANC	CONNECTEUR T RGB		8,20 B
ST122	BLANC	CONNECTEUR X RGB		12,40 B

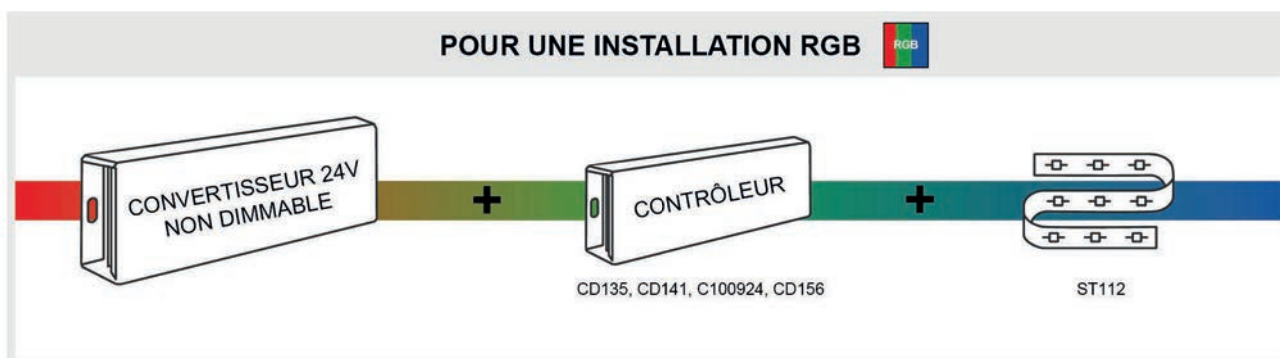

# ST159

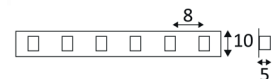

- Bandeau LED étanche (SMD 2835).
- Rouleau 5m.
- Précâblé en début et fin de bandeau.
- Autocollant.
- IP67 non coupé. Sécable toutes les 6 LEDs, 50mm.
- Accessoires inclus (5 embouts, 10 clips).
- Convertisseur à commander séparément.

ST159	LED	T°	LED Lumen	L (mm)	€
ST159SW	14,4W/m	2700K	1080 Lm/m	5000	152,40 B
ST159WW	14,4W/m	3000K	1143 Lm/m	5000	152,40 B
ST159NW	14,4W/m	4000K	1188 Lm/m	5000	152,40 B
ST159CW	14,4W/m	6000K	1143 Lm/m	5000	152,40 B

## POUR UNE INSTALLATION MONOCHROME NON DIMMABLE

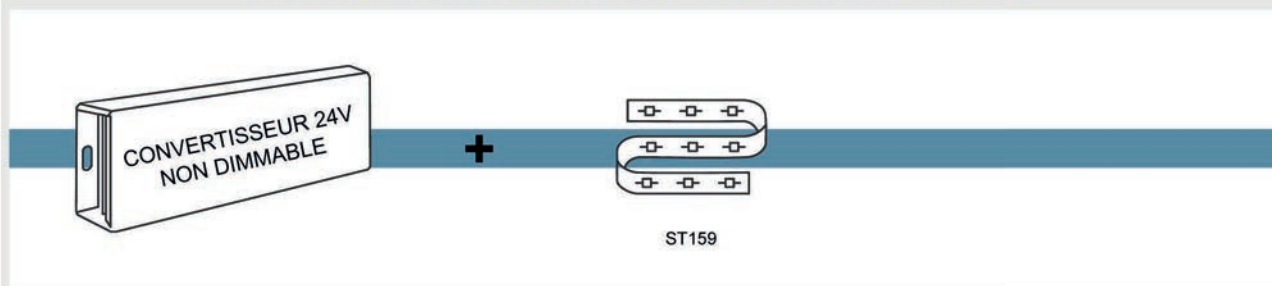

## POUR UNE INSTALLATION MONOCHROME DIMMABLE

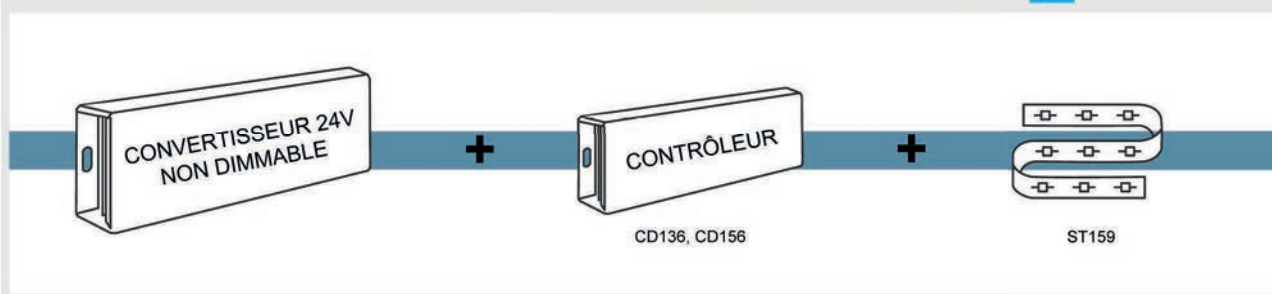



# ST123



- Bandeau LED RGB étanche.
- Rouleau 5m.
- Précâblé en début et fin de bandeau.
- Autocollant.
- IP67 non coupé. Sécable toutes les 6 LEDs, 100mm.
- Accessoires inclus (5 embouts, 10 clips).
- Convertisseur et contrôleur à commander séparément.

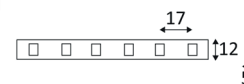

ST123	LED	T°	L (mm)	€
ST123RGB	14,4W/m	RGB	5000	173,00 B

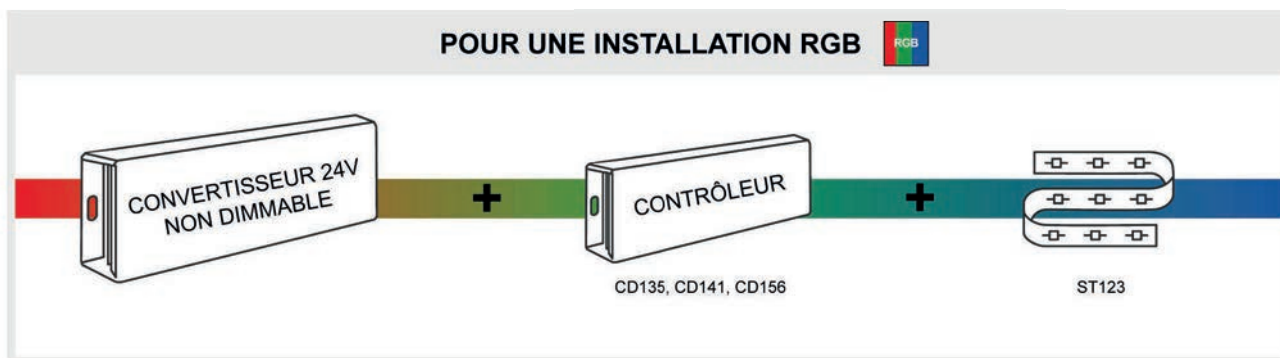

# ST132

	<b>CRI</b> >90	<b>3</b>
<b>IP</b> 33	2700K 6000K	24V DC

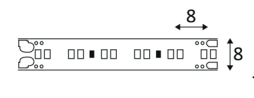

- Bandeau LED blanc dynamique (SMD 2216).
- Rouleau 5m.
- Précâblé en début et fin de bandeau.
- Autocollant.
- Sécable toutes les 12 LEDs, 50mm.
- Convertisseur et contrôleur à commander séparément.

ST132	LED	T°	LED Lumen	L (mm)	€
ST132SWW	9,6W/m	2700-6000K	720 Lm/m (2700K)	5000	148,30 B

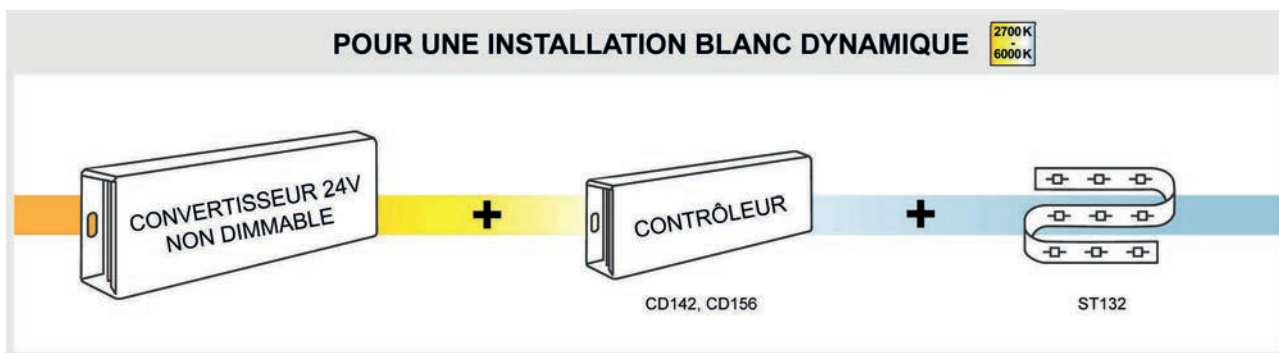



# ST125



3

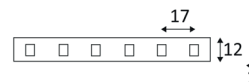

- Bandeau LED RGB+W (SMD 5050).
- Rouleau 5m.
- Précâblé en début et fin de bandeau.
- Autocollant.
- Sécable toutes les 6 LEDs, 100mm.
- Convertisseur, contrôleur et accessoires à commander séparément.



ST125	LED	T°	LED Lumen	L (mm)	€
ST125RGBW	19,2W/m	RGB+W (6000K)	320 Lm/m (6000K)	5000	185,40 B

**ACCESSOIRES** €

ST126	BLANC	CONNECTEUR RGBW		1,00 B
ST127	BLANC	INTERCONNECTEUR RGBW		2,10 B
ST128	BLANC	CONNECTEUR L RGBW		1,00 B
ST129	BLANC	CONNECTEUR T RGBW		1,00 B
ST130	BLANC	CONNECTEUR X RGBW		1,00 B

## POUR UNE INSTALLATION RGB+W

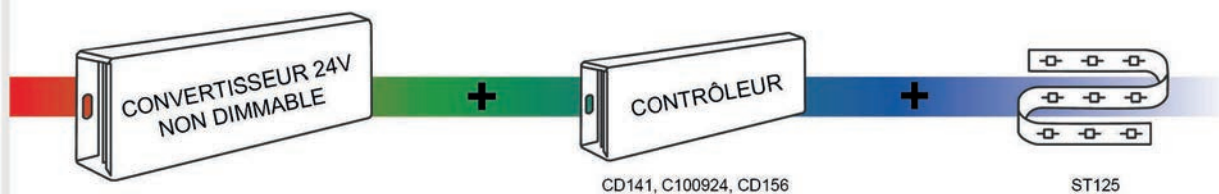

# ST160

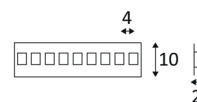
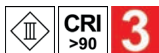

- Bandeau LED (SMD 2835).
- Rouleau 5m.
- Précâblé en début et fin de bandeau.
- Autocollant.
- Sécable toutes les 6 LEDs, 25mm.
- Convertisseur à commander séparément.

ST160	LED	T°	LED Lumen	L (mm)	€
ST160WW	22W/m	3000K	2459 Lm/m	5000	150,40 B
ST160NW	22W/m	4000K	2493 Lm/m	5000	150,40 B
ST160CW	22W/m	6000K	2459 Lm/m	5000	150,40 B

**ACCESSOIRES** €

ST161 CONNECTEUR

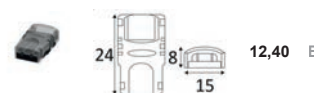

ST162 INTERCONNECTEUR

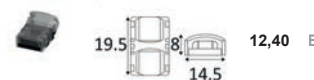

## POUR UNE INSTALLATION MONOCHROME NON DIMMABLE

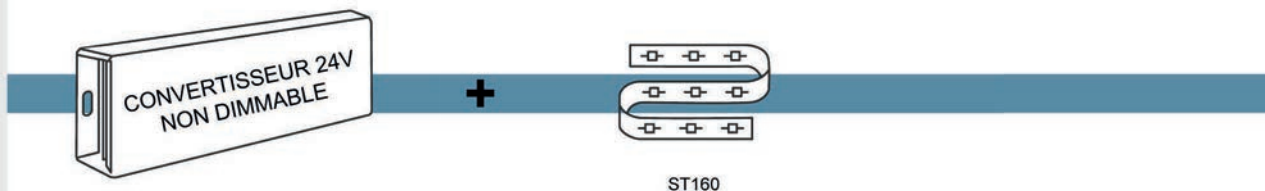

## POUR UNE INSTALLATION MONOCHROME DIMMABLE

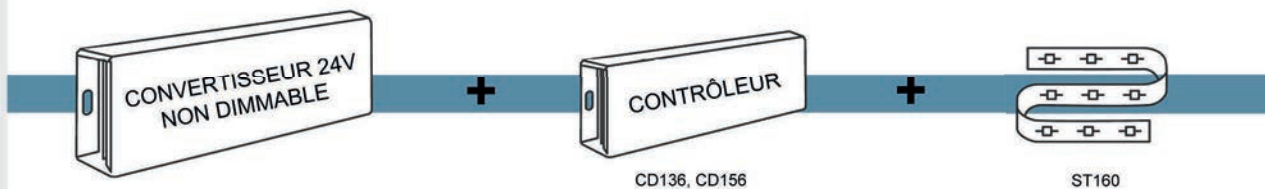



# ST135

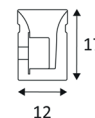

- Bandeau LED étanche (SMD 2835).
- Rouleau 5m. Précâblé en début de bandeau.
- Sécable tous les 50mm (uniquement 3000K et 4000K) et tous les 83mm (RGB).
- Convertisseur, contrôleur et accessoires à commander séparément.
- Accessoires compatibles uniquement avec ST135WW et ST135NW sauf profils et embout.

ST135	LED	T°	LED Lumen	System Lumen	L (mm)	€
ST135WW	9,6W/m	3000K	520 Lm/m	479 Lm/m	5000	197,80 B
ST135NW	9,6W/m	4000K	550 Lm/m	509 Lm/m	5000	197,80 B
ST135RGB	12W/m	RGB	-	-	5000	234,80 B

**ACCESSOIRES** €

WW, NW				€
ST136	CONNECTEUR+CABLE FIN			14,40 B
ST137	CONNECTEUR+CABLE BAS			11,30 B
ST138	CONNECTEUR+CABLE GAUCHE			14,40 B
ST139	CONNECTEUR+CABLE DROIT			14,40 B
ST140	INTERCONNECTEUR			12,40 B
ST141	INTERCONNECTEUR+CABLE 30cm			25,80 B
WW, NW, RGB				€
ST142	PROFIL FLEXIBLE L:0,5m 2 PC			29,90 B
ST143	PROFIL PC L:1m			9,30 B
ST144	PROFIL ALUMINIUM L:1m			12,40 B
ST145	EMBOUT			8,20 B





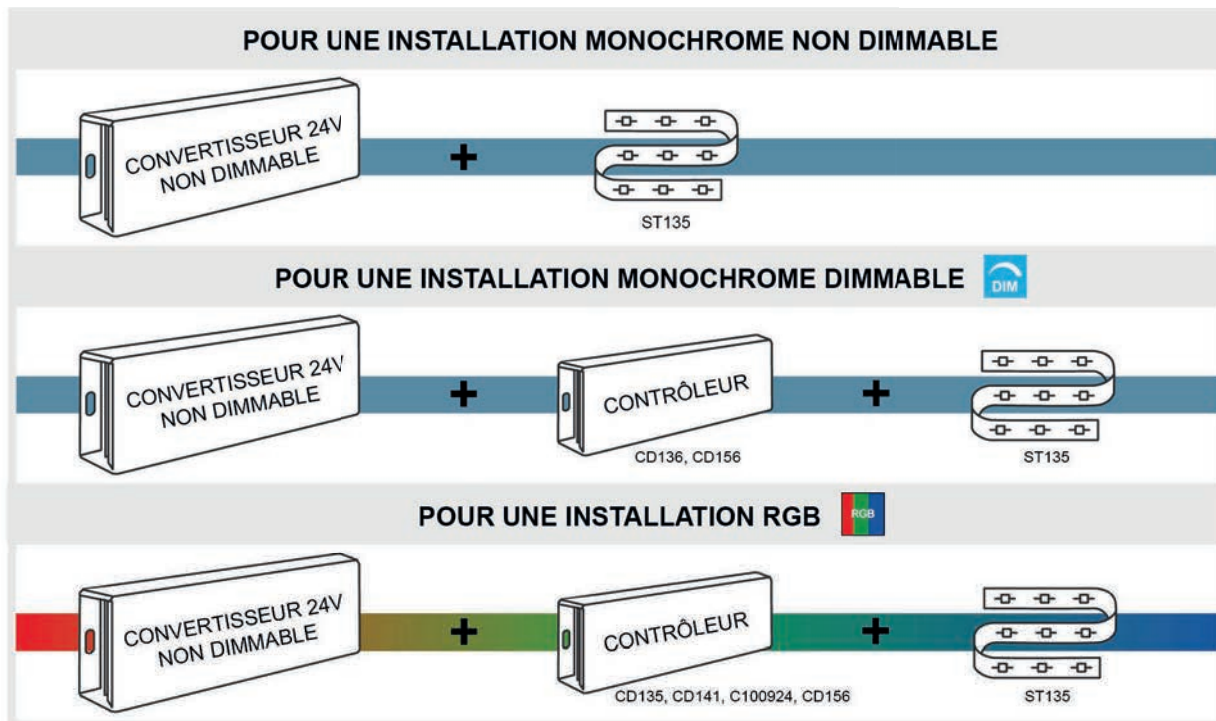





# PR115

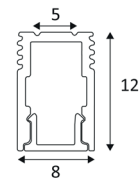
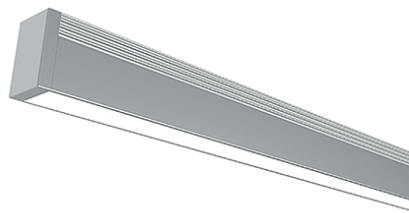

- Profil apparent pour bandeau LED.
- Compatible avec ST104.
- Diffuseur en polycarbonate, 2 embouts de finition fournis.
- Montage mural ou au plafond.
- Clips de montage, bandeau LED et convertisseur à commander séparément.



PR115	MATIÈRE		L (mm)	€
PR11530	BLANC MAT	ALUMINIUM	2000	44,30 B
PR11552	ALUMINIUM	ALUMINIUM	2000	44,30 B

ACCESSOIRES		MATIÈRE			€
PR14052	ALUMINIUM	INOX 304	CLIPS DE MONTAGE 4PC		3,10 B
PR11630	BLANC MAT	POLYCARBONATE	EMBOUS PERCES 2PC		5,20 B
PR11652	ALUMINIUM	POLYCARBONATE	EMBOUS PERCES 2PC		5,20 B

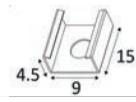

BLANC MAT



ALUMINIUM





# PR139

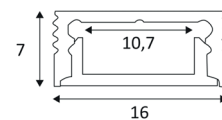

- Profil apparent pour bandeau LED.
- Compatible avec ST104, ST150, ST153, ST132.
- Diffuseur en polycarbonate, 2 embouts de finition fournis.
- Montage mural ou au plafond.
- Clips de montage, bandeau LED et convertisseur à commander séparément.

PR139	MATIÈRE		L (mm)	€
PR13930	BLANC MAT	ALUMINIUM	2500	36,10 B
PR13952	ALUMINIUM	ALUMINIUM	2500	36,10 B

ACCESSOIRES		MATIÈRE			€
PR14152	ALUMINIUM	INOX 304	CLIPS DE MONTAGE 4PC		3,10 B
					
PR14530	BLANC MAT	POLYCARBONATE	EMBOUS PERCES 2PC		3,10 B
PR14552	ALUMINIUM	POLYCARBONATE	EMBOUS PERCES 2PC		4,10 B
PR11952	ALUMINIUM	INOX 304	CLIPS DE MONTAGE 45° 4PC		6,20 B
					
PR12052	ALUMINIUM	INOX 304	CLIPS DE MONTAGE ORIENTABLE 0-180° 4PC		19,60 B
					



BLANC MAT

ALUMINIUM



# PR117

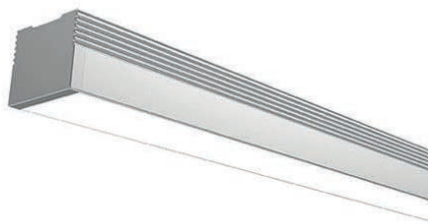
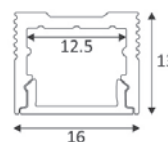

- Profil pour bandeau LED.
- Compatible avec ST104, ST150, ST153, ST125, ST160, ST132.
- Diffuseur en polycarbonate, 2 embouts de finition fournis.
- Montage apparent ou encastré (encastrement 16x13x2000mm).
- Clips de montage, bandeau LED et convertisseur à commander séparément.

PR117	MATIÈRE		L (mm)	€
PR11730	BLANC MAT	ALUMINIUM	2000	56,70 B
PR11752	ALUMINIUM	ALUMINIUM	2000	56,70 B

ACCESSOIRES		MATIÈRE			€
PR14152	ALUMINIUM	INOX 304	CLIPS DE MONTAGE 4PC		3,10 B
PR11830	BLANC MAT	POLYCARBONATE	EMBOUITS PERCES 2PC		5,20 B
PR11852	ALUMINIUM	POLYCARBONATE	EMBOUITS PERCES 2PC		5,20 B
PR11952	ALUMINIUM	INOX 304	CLIPS DE MONTAGE 45° 4PC		6,20 B
PR12052	ALUMINIUM	INOX 304	CLIPS DE MONTAGE ORIENTABLE 0-180° 4PC		19,60 B



BLANC MAT

ALUMINIUM









# PR121

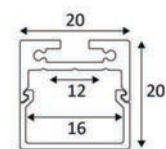
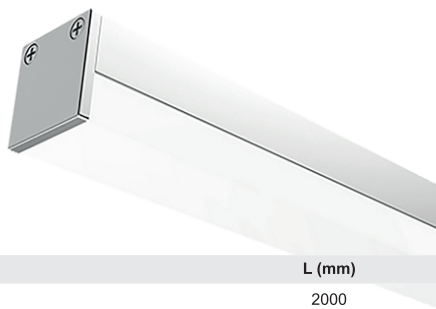

- Profil apparent pour bandeau LED.
- Compatible avec ST153, ST156, ST112, ST159, ST123, ST132.
- Diffuseur en polycarbonate, 2 embouts de finition fournis.
- Montage mural, au plafond ou en suspension.
- Clips de montage, bandeau LED et convertisseur à commander séparément.



PR121	MATIÈRE		L (mm)	€
PR12130	BLANC MAT	ALUMINIUM	2000	76,20 B
PR12152	ALUMINIUM	ALUMINIUM	2000	76,20 B

ACCESSOIRES		MATIÈRE			€
PR14252	ALUMINIUM	INOX 304	CLIPS DE MONTAGE 4PC		5,20 B
PR12230	BLANC MAT	POLYCARBONATE	EMBOUTS PERCES 2PC		6,20 B
PR12252	ALUMINIUM	POLYCARBONATE	EMBOUTS PERCES 2PC		6,20 B
PR12330	BLANC MAT	ALUMINIUM	KIT SUSPENSION L:2000mm		61,80 B
PR12352	ALUMINIUM	ALUMINIUM	KIT SUSPENSION L:2000mm		61,80 B
PR12452	ALUMINIUM	ALUMINIUM	CONNECTEUR L:55mm 4PC		17,50 B



BLANC MAT

ALUMINIUM





# PR127

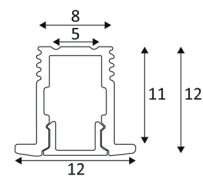
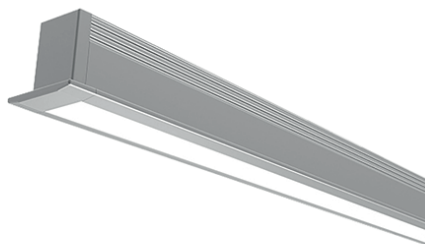

- Profil encastrable pour bandeau LED.
- Compatible avec ST104.
- Encastrement 10x13x2000mm.
- Diffuseur en polycarbonate, 2 embouts de finition fournis.
- Bandeau LED et convertisseur à commander séparément.

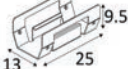

PR127	MATIÈRE		L (mm)	€
PR12730	BLANC MAT	ALUMINIUM	2000	44,30 B
PR12752	ALUMINIUM	ALUMINIUM	2000	44,30 B

ACCESSOIRES				MATIÈRE	€
PR12830	BLANC MAT	POLYCARBONATE	EMBOUITS PERCES 2PC		5,20 B
PR12852	ALUMINIUM	POLYCARBONATE	EMBOUITS PERCES 2PC		5,20 B
PR12952	ALUMINIUM	INOX 304	ETRIER D'ENCASTREMENT 4PC	 	4,10 B



BLANC MAT



ALUMINIUM





# PR130

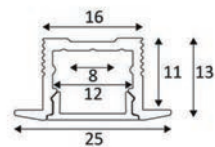

- Profil encastrable pour bandeau LED.
- Compatible avec ST104, ST150, ST153, ST125, ST160, ST132.
- Encastrement 19x13x2000mm.
- Diffuseur en polycarbonate, 2 embouts de finition fournis.
- Bandeau LED et convertisseur à commander séparément.

PR130	MATIÈRE		L (mm)	€
PR13030	BLANC MAT	ALUMINIUM	2000	62,80 B
PR13052	ALUMINIUM	ALUMINIUM	2000	62,80 B

ACCESSOIRES				MATIÈRE	€
PR13130	BLANC MAT	POLYCARBONATE	EMBOUTS PERCES 2PC		6,20 B
PR13152	ALUMINIUM	POLYCARBONATE	EMBOUTS PERCES 2PC		5,20 B
PR13252	ALUMINIUM	INOX 304	ETRIER D'ENCASTREMENT 4PC	 	4,10 B



BLANC MAT

ALUMINIUM



# PR146



- Profil encastrable pour bandeau LED.
- Encastrement 22x12x2500mm.
- Compatible avec ST159, ST123.
- Diffuseur en polycarbonate, 2 embouts de finition fournis.
- Bandeau LED et convertisseur à commander séparément.

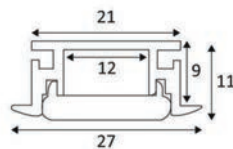

PR146	MATIÈRE		L (mm)	€
PR14652	ALUMINIUM	ALUMINIUM	2500	65,90 B

ACCESSOIRES	MATIÈRE			€
PR14752	ALUMINIUM	POLYCARBONATE	EMBOUTS 2PC	1,00 B











# PR133

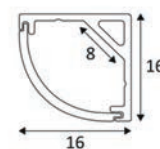

- Profil apparent pour bandeau LED.
- Compatible avec ST150, ST153, ST132.
- Diffuseur en polycarbonate, 2 embouts de finition fournis.
- Montage mural.
- Clips de montage, bandeau LED et convertisseur à commander séparément.



PR133	MATIÈRE		L (mm)	€
PR13330	BLANC MAT	ALUMINIUM	2000	53,60 B
PR13352	ALUMINIUM	ALUMINIUM	2000	53,60 B

ACCESSOIRES		MATIÈRE			€
PR14352	ALUMINIUM	INOX 304	CLIPS DE MONTAGE 4PC		5,20 B
PR13430	BLANC MAT	POLYCARBONATE	EMBOUS PERCES 2PC		5,20 B
PR13452	ALUMINIUM	POLYCARBONATE	EMBOUS PERCES 2PC		5,20 B



BLANC MAT



ALUMINIUM





# PR135

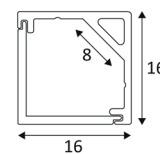
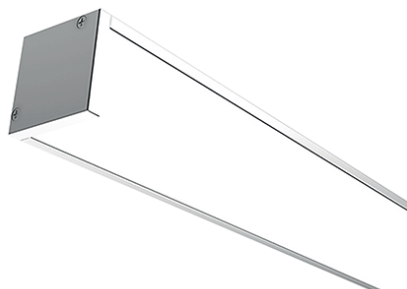

- Profil apparent pour bandeau LED.
- Compatible avec ST150, ST153, ST132.
- Diffuseur en polycarbonate, 2 embouts de finition fournis.
- Montage mural.
- Clips de montage, bandeau LED et convertisseur à commander séparément.



PR135	MATIÈRE		L (mm)	€
PR13530	BLANC MAT	ALUMINIUM	2000	56,70 B
PR13552	ALUMINIUM	ALUMINIUM	2000	56,70 B

ACCESSOIRES		MATIÈRE			€
PR14352	ALUMINIUM	INOX 304	CLIPS DE MONTAGE 4PC		5,20 B
PR13630	BLANC MAT	POLYCARBONATE	EMBOUITS PERCES 2PC		5,20 B
PR13652	ALUMINIUM	POLYCARBONATE	EMBOUITS PERCES 2PC		5,20 B



BLANC MAT



ALUMINIUM





# PR137

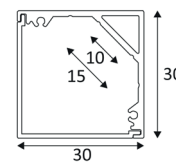
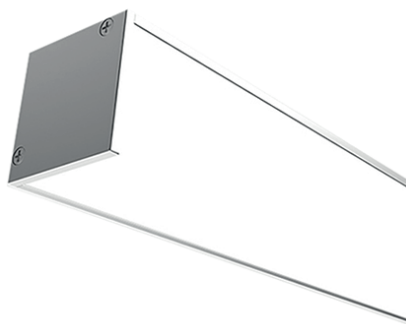

- Profil apparent pour bandeau LED.
- Compatible avec ST156, ST112, ST159, ST123, ST125, ST160.
- Diffuseur en polycarbonate, 2 embouts de finition fournis.
- Montage mural.
- Clips de montage, bandeau LED et convertisseur à commander séparément.

PR137	MATIÈRE		L (mm)	€
PR13730	BLANC MAT	ALUMINIUM	2000	94,80 B
PR13752	ALUMINIUM	ALUMINIUM	2000	94,80 B

ACCESSOIRES		MATIÈRE			€
PR14452	ALUMINIUM	INOX 304	CLIPS DE MONTAGE 4PC		5,20 B
PR13830	BLANC MAT	POLYCARBONATE	EMBOUITS PERCES 2PC		6,20 B
PR13852	ALUMINIUM	POLYCARBONATE	EMBOUITS PERCES 2PC		6,20 B



BLANC MAT

ALUMINIUM





# INDIGO

LIGHTING



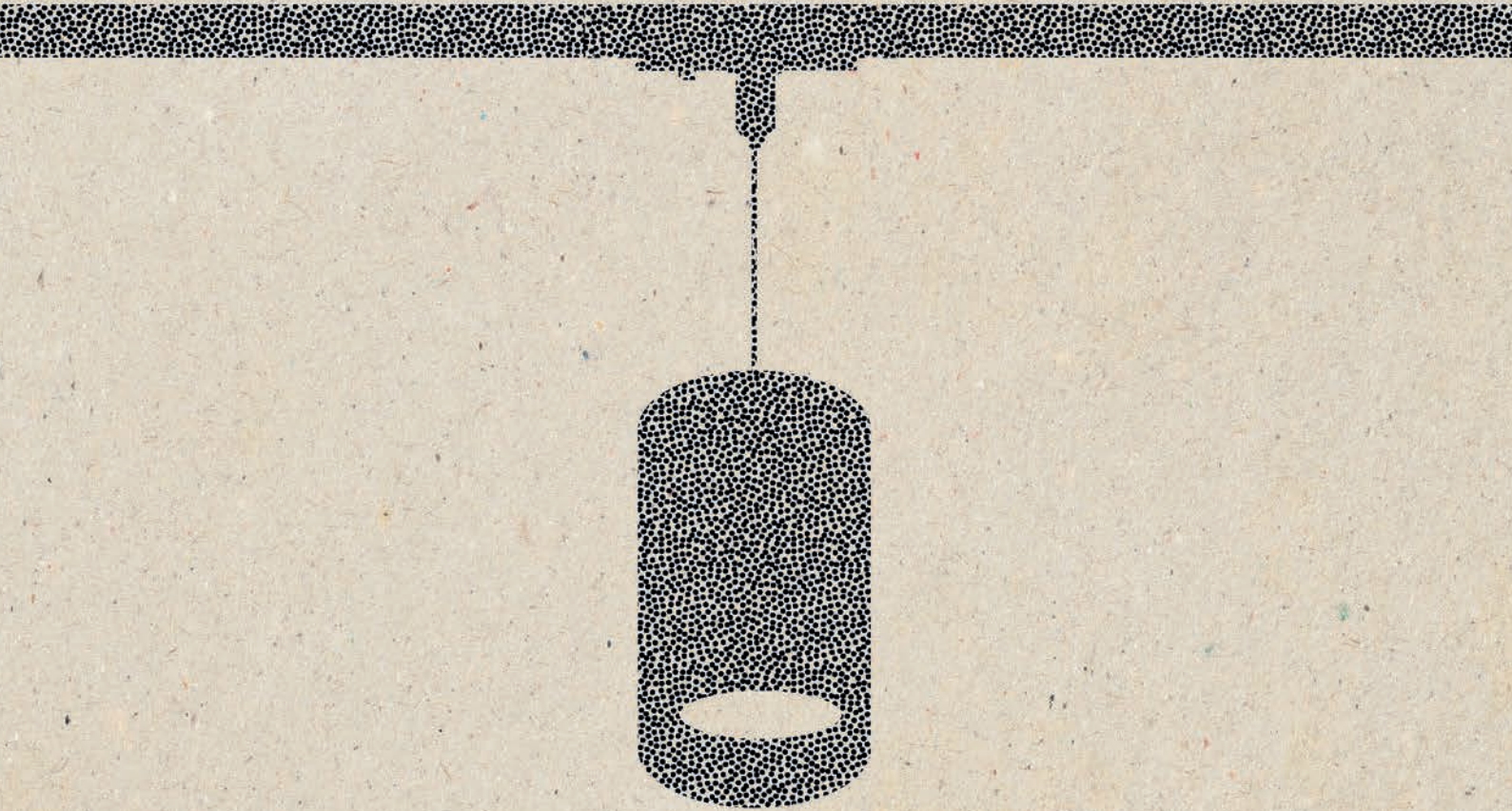

**RAILS & PROJECTEURS  
1 ALLUMAGE**

## TRACK UNO

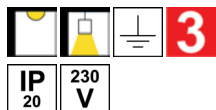

- Rail apparent.
- Tension secteur 220/250V.  
Le raccordement au monophasé autorise une intensité totale de 16A, qui correspond à 3680VA.
- Le rail peut supporter une charge de 10kg maximum entre 2 points de fixation.
- La pièce de renfort TR411 peut s'adapter au kit de suspension TR412.

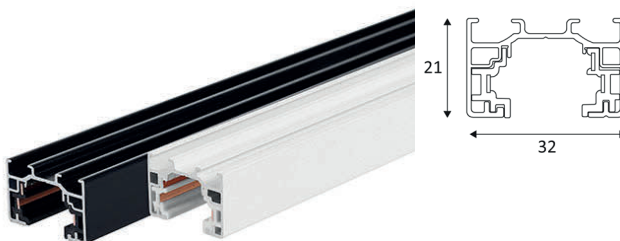

TRACK UNO			MATIÈRE	Watt Max	L (mm)	€
TR40105	■ NOIR	BLACK	ALUMINIUM	3680VA	2000	75,20 B
TR40104	■ BLANC	WHITE	ALUMINIUM	3680VA	2000	75,20 B
TR40205	■ NOIR	BLACK	ALUMINIUM	3680VA	3000	112,30 B
TR40204	■ BLANC	WHITE	ALUMINIUM	3680VA	3000	112,30 B

### ENTRAXES DE FIXATION

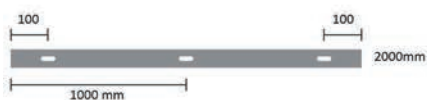

### CHARGE SUPPORTÉE

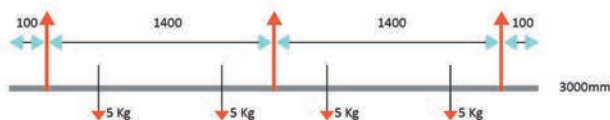
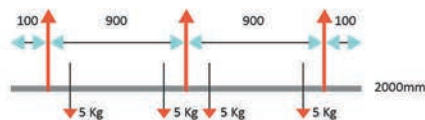

### MONOPHASE

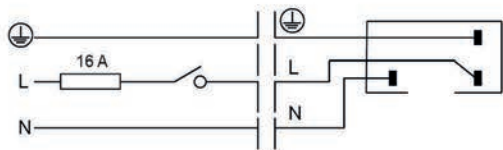

### VUE EN PLAN

Les accessoires sont reliés aux rails de manière à assurer la continuité électrique et mécanique de l'installation, ainsi que la continuité de la mise à la terre.



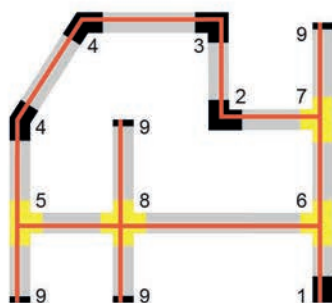















La position latérale du fil de mise à la terre rend la structure asymétrique et, de ce fait, les raccords de connexion sont orientés gauche-droite ou intérieur-extérieur.



- 1 ALIMENTATION GAUCHE
- 2 CONNEXION L 90° INTERIEURE
- 3 CONNEXION L 90° EXTERIEURE
- 4 CONNEXION L 20°-180° EXTERIEURE
- 5 CONNEXION T EXTERIEURE DROITE
- 6 CONNEXION T INTERIEURE GAUCHE
- 7 CONNEXION T INTERIEURE DROITE
- 8 CONNEXION EN CROIX
- 9 EMBOUT DE FINITION



## TRACK UNO ACCESSOIRES

€		€		€							
<b>ALIMENTATION DROITE</b>		<b>CONNEXION T EXTERIEURE DROITE</b>		<b>MOULURE DE FINITION L:200cm</b>							
TR40305	  32 105	6,20	B	TR44005	  108 184	16,00	B	TR41404		18,50	B
TR40304		6,20	B	TR44004		16,00	B	<b>MOULURE DE FINITION L:300cm</b>			
<b>ALIMENTATION GAUCHE</b>		<b>CONNEXION T INTERIEURE GAUCHE</b>		TR41505		 30 3000	27,80	B			
TR40405	 32 105	6,20	B	TR44305	 108 184	16,00	B	TR41504		27,80	B
TR40404		6,20	B	TR44304		16,00	B				
<b>ALIMENTATION CENTRALE</b>		<b>CONNEXION T EXTERIEURE GAUCHE</b>									
TR40505	 32 184	13,40	B	TR44205	 108 184	16,00	B				
TR40504		13,40	B	TR44204		16,00	B				
<b>CONNEXION ELECTRIQUE</b>		<b>CONNEXION EN CROIX</b>									
TR40605	 19 96	9,30	B	TR44405	 184 184	23,50	B				
TR40604		9,30	B	TR44404		23,50	B				
<b>CONNEXION L 90° INTERIEURE</b>		<b>ADAPTATEUR 6A AVEC TUBE FILETE M10 MAX 5KG</b>									
TR40705	 108 108	13,40	B	TR41005	 34 85	6,20	B				
TR40704		13,40	B	TR41004		6,20	B				
<b>CONNEXION L 90° EXTERIEURE</b>		<b>PIECE DE RENFORT L:8cm</b>									
TR40805	 108 108	13,40	B	TR41120	 30 80	10,00	B				
TR40804		13,40	B	TR41105		10,00	A				
<b>CONNEXION 20-180° INTERIEURE</b>		<b>KIT SUSPENSION L:150cm</b>									
TR40905	 32 215	24,70	B	TR41205	 42 1500 30	21,60	B				
TR40904		24,70	B	TR41204		21,60	B				
<b>CONNEXION 20-180° EXTERIEURE</b>		<b>EMBOUT DE FINITION</b>									
TR42105	 32 215	27,80	B	TR41305	 23 32	1,00	B				
TR42104		27,80	B	TR41304		1,00	B				
<b>CONNEXION T INTERIEURE DROITE</b>		<b>MOULURE DE FINITION L:200cm</b>									
TR44105	 108 184	16,00	B	TR41405	 30 2000	18,50	B				
TR44104		16,00	B								

## YERA 1 T GU10

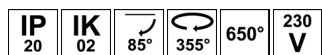

- Projecteur pour éclairage d'accentuation.
- Adaptateur pour Track UNO.

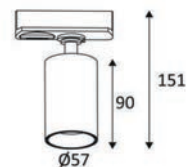

YERA 1 T GU10		MATIÈRE	SOCKET	LAMP	Watt Max	€
TR43105	■ NOIR MAT	ALUMINIUM	GU10	PAR16 LED	10W	41,20 B
TR43130	■ BLANC MAT	ALUMINIUM	GU10	PAR16 LED	10W	41,20 B



NOIR MAT



BLANC MAT

## YERA 1 TP GU10

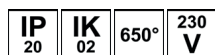

- Suspension décorative.
- Adaptateur pour Track UNO.
- Livrée avec câble d'alimentation textile noir ou blanc (réglable 1.50m max).

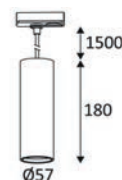

YERA 1 TP GU10		MATIÈRE	SOCKET	LAMP	Watt Max	€
TR43205	■ NOIR MAT	ALUMINIUM	GU10	PAR16 LED	10W	71,10 B
TR43230	■ BLANC MAT	ALUMINIUM	GU10	PAR16 LED	10W	71,10 B



NOIR MAT



BLANC MAT





# OKTO T GU10

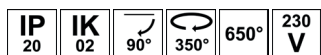

- Projecteur pour éclairage d'accentuation.
- Adaptateur pour Track UNO.

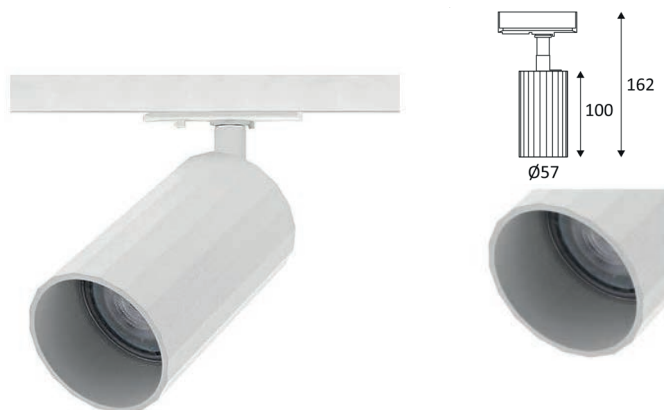

OKTO T GU10		MATIÈRE	SOCKET	LAMP	Watt Max	€
TR41905		NOIR MAT	ALUMINIUM	GU10	PAR16 LED	10W 53,60 B
TR41908		NOIR MAT - CHAMPAGNE	ALUMINIUM	GU10	PAR16 LED	10W 58,70 B
TR41906		NOIR MAT - OR ROSE	ALUMINIUM	GU10	PAR16 LED	10W 58,70 B
TR41983		NOIR MAT - ROSE	ALUMINIUM	GU10	PAR16 LED	10W 58,70 B
TR41930		BLANC MAT	ALUMINIUM	GU10	PAR16 LED	10W 53,60 B
TR41949		BLANC MAT - CHAMPAGNE	ALUMINIUM	GU10	PAR16 LED	10W 58,70 B
TR41902		BLANC MAT - OR ROSE	ALUMINIUM	GU10	PAR16 LED	10W 58,70 B
TR41982		BLANC MAT - ROSE	ALUMINIUM	GU10	PAR16 LED	10W 58,70 B

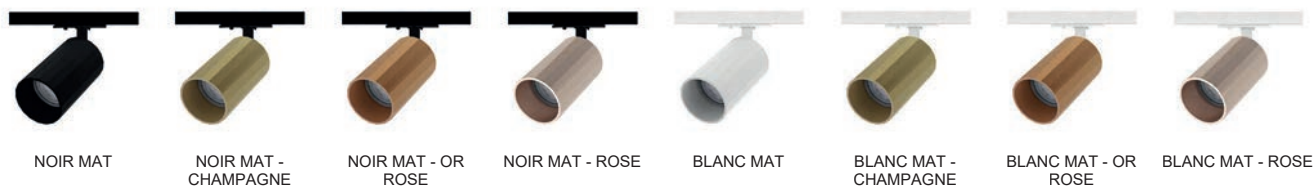



## OKTO TP GU10

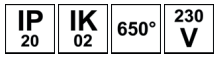
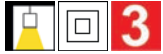

- Suspension décorative.
- Adaptateur pour Track UNO.
- Livrée avec câble d'alimentation textile (réglable 1.50m max).  
Coloris 05 - 08 - 06 - 83 : câble noir.  
Coloris 30 - 49 - 02 - 82 : câble blanc.



OKTO TP	GU10	MATIÈRE	SOCKET	LAMP	Watt Max	€
TR42005	■ NOIR MAT	ALUMINIUM	GU10	PAR16 LED	10W	75,20 B
TR42008	■ NOIR MAT - CHAMPAGNE	ALUMINIUM	GU10	PAR16 LED	10W	79,30 B
TR42006	■ NOIR MAT - OR ROSE	ALUMINIUM	GU10	PAR16 LED	10W	79,30 B
TR42083	■ NOIR MAT - ROSE	ALUMINIUM	GU10	PAR16 LED	10W	79,30 B
TR42030	■ BLANC MAT	ALUMINIUM	GU10	PAR16 LED	10W	75,20 B
TR42049	■ BLANC MAT - CHAMPAGNE	ALUMINIUM	GU10	PAR16 LED	10W	79,30 B
TR42002	■ BLANC MAT - OR ROSE	ALUMINIUM	GU10	PAR16 LED	10W	79,30 B
TR42082	■ BLANC MAT - ROSE	ALUMINIUM	GU10	PAR16 LED	10W	79,30 B



## JACK T

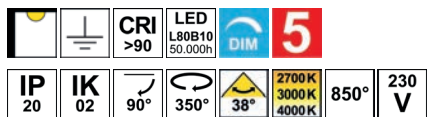

- Projecteur pour éclairage d'accentuation.
- Adaptateur pour Track UNO.
- 2700K, 3000K ou 4000K au choix via un interrupteur à l'arrière du luminaire.
- Convertisseur dimmable intégré dans l'appareil.
- Compatible avec variateur fin de phase.

JACK T		MATIÈRE	LED	T°	LED Lumen	System Lumen	€	
TR42805		NOIR MAT	ALUMINIUM	10W	2700-3000-4000K	1120 Lm (4000K)	770 Lm (4000K)	76,20 B
TR42813		NOIR MAT - LAITON	ALUMINIUM	10W	2700-3000-4000K	1120 Lm (4000K)	770 Lm (4000K)	77,30 B
TR42806		NOIR MAT - OR ROSE	ALUMINIUM	10W	2700-3000-4000K	1120 Lm (4000K)	770 Lm (4000K)	95,80 B
TR42830		BLANC MAT	ALUMINIUM	10W	2700-3000-4000K	1120 Lm (4000K)	770 Lm (4000K)	76,20 B
TR42828		BLANC MAT - LAITON	ALUMINIUM	10W	2700-3000-4000K	1120 Lm (4000K)	770 Lm (4000K)	95,80 B
TR42802		BLANC MAT - OR ROSE	ALUMINIUM	10W	2700-3000-4000K	1120 Lm (4000K)	770 Lm (4000K)	95,80 B

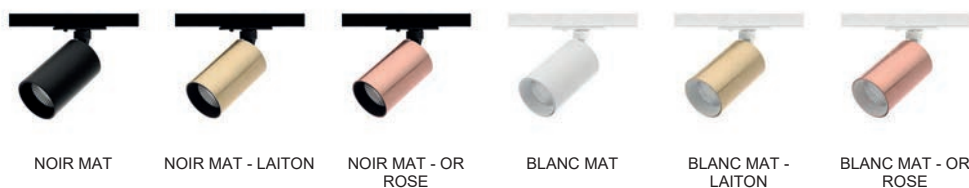



## JACK TP

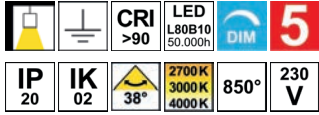

- Suspension décorative.
- Adaptateur pour Track UNO.
- Livrée avec câble d'alimentation (réglable 2.00m max).  
Coloris 05 - 13 - 06 : câble noir.  
Coloris 30 - 28 - 02 : câble blanc.
- 2700K, 3000K ou 4000K au choix via un interrupteur à l'arrière du luminaire.
- Convertisseur dimmable intégré dans l'appareil.
- Compatible avec variateur fin de phase.

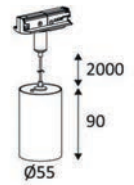

JACK TP		MATIÈRE	LED	T°	LED Lumen	System Lumen	€	
TR42905		NOIR MAT	ALUMINIUM	10W	2700-3000-4000K	1120 Lm (4000K)	770 Lm (4000K)	81,40 B
TR42913		NOIR MAT - LAITON	ALUMINIUM	10W	2700-3000-4000K	1120 Lm (4000K)	770 Lm (4000K)	100,90 B
TR42906		NOIR MAT - OR ROSE	ALUMINIUM	10W	2700-3000-4000K	1120 Lm (4000K)	770 Lm (4000K)	100,90 B
TR42930		BLANC MAT	ALUMINIUM	10W	2700-3000-4000K	1120 Lm (4000K)	770 Lm (4000K)	81,40 B
TR42928		BLANC MAT - LAITON	ALUMINIUM	10W	2700-3000-4000K	1120 Lm (4000K)	770 Lm (4000K)	100,90 B
TR42902		BLANC MAT - OR ROSE	ALUMINIUM	10W	2700-3000-4000K	1120 Lm (4000K)	770 Lm (4000K)	100,90 B



## RAY

		<b>CRI</b> >90	<b>LED</b> L80B10 50.000h	<b>UGR</b> <19	<b>5</b>
<b>IP</b> 20	<b>IK</b> 02	 90°	 350°	 38°	<b>2700K</b> <b>3000K</b> <b>4000K</b>
					<b>850°</b>
					<b>230 V</b>



- Projecteur pour éclairage d'accentuation.
- Adaptateur pour Track UNO.
- 2700K, 3000K ou 4000K au choix via un interrupteur à l'arrière du luminaire.
- Convertisseur non dimmable ou dimmable intégré dans l'appareil.

RAY	MATIÈRE	LED	T°	LED Lumen	System Lumen	€
<b>NON DIMMABLE</b>						
<b>TR41805</b>	NOIR MAT	ALUMINIUM	13W	2700-3000-4000K	1405 Lm (4000K)	995 Lm (4000K) <b>95,80</b> B
<b>TR41830</b>	BLANC MAT	ALUMINIUM	13W	2700-3000-4000K	1405 Lm (4000K)	1015 Lm (4000K) <b>95,80</b> B
<b>DIMMABLE COUPURE DE PHASE</b>						
<b>TR43005</b>	NOIR MAT	ALUMINIUM	15W	2700-3000-4000K	1580 Lm (4000K)	1050 Lm (4000K) <b>109,20</b> B
<b>TR43030</b>	BLANC MAT	ALUMINIUM	15W	2700-3000-4000K	1580 Lm (4000K)	1050 Lm (4000K) <b>109,20</b> B



NOIR MAT

BLANC MAT





# INDIGO

LIGHTING







**RAILS & PROJECTEURS**

**3 ALLUMAGES**

## TRACK III SURFACE

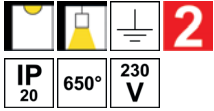

- Rail apparent.
- Tension secteur 220/250V.  
Le raccordement au triphasé autorise une intensité totale de 16A sur chaque circuit. Ce qui correspond à 3 x 3680VA = 11040VA.
- Un rail peut supporter une charge de 6kg/0.20m avec une distance max de 1.00m entre les points de fixation ou une charge de 3kg/0.20m avec une distance max de 2.00m entre les points de fixation.

TRACK III SURFACE			MATIÈRE	Watt Max	L (mm)	€
TR22030	■ NOIR	BLACK	ALUMINIUM	(3x) 3680VA	1000	<b>36,10</b> B
TR22031	■ BLANC	WHITE	ALUMINIUM	(3x) 3680VA	1000	<b>36,10</b> B
TR22130	■ NOIR	BLACK	ALUMINIUM	(3x) 3680VA	2000	<b>70,00</b> B
TR22131	■ BLANC	WHITE	ALUMINIUM	(3x) 3680VA	2000	<b>70,00</b> B
TR22230	■ NOIR	BLACK	ALUMINIUM	(3x) 3680VA	3000	<b>104,00</b> B
TR22231	■ BLANC	WHITE	ALUMINIUM	(3x) 3680VA	3000	<b>104,00</b> B

### CHARGE POIDS D'INSTALLATION

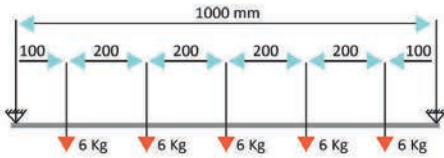

### TRIPHASE

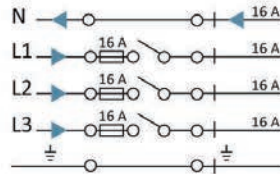

### MONOPHASE

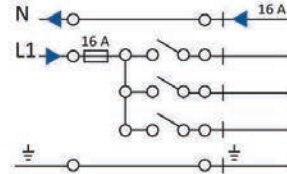

### VUE EN PLAN

Les accessoires sont reliés aux rails de manière à assurer la continuité électrique et mécanique de l'installation, ainsi que la continuité de la mise à la terre.



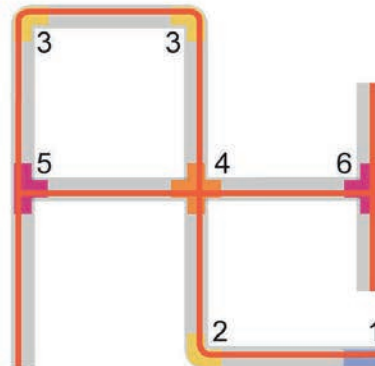

La position latérale du fil de mise à la terre rend la structure asymétrique et, de ce fait, les raccords de connexion sont orientés gauche-droite ou intérieur-extérieur.



- 1 ALIMENTATION DROITE
- 2 CONNEXION L 90° INTÉRIEURE
- 3 CONNEXION L 90° EXTÉRIEURE
- 4 CONNEXION EN CROIX
- 5 CONNEXION T DROITE
- 6 CONNEXION T GAUCHE



## TRACK III SURFACE ACCESSOIRES

€		€		€	
<b>ALIMENTATION DROITE</b>		<b>CONNEXION T DROITE</b>		<b>EMBOUT DE FINITION</b>	
TR22330	 35 99 65 17,50 B	TR23131	 42,20 B	TR23730	 35 31 2,10 B
TR22331	 16,50 B	<b>CONNEXION T GAUCHE</b>		TR23731	 2,10 B
<b>ALIMENTATION GAUCHE</b>		TR23230	 101 166 42,20 B	<b>MOULURE DE FINITION L:300cm</b>	
TR22430	 35 99 65 16,50 B	TR23231	 42,20 B	TR23830	 3000 6,20 B
TR22431	 16,50 B	<b>CONNEXION ELECT. SOUPLE</b>		TR23831	 6,20 B
<b>ALIMENTATION CENTRALE</b>		TR36030	 182 249 37,00 B	<b>BASE APPARENTE</b>	
TR22530	 35 166 99 28,80 B	TR36031	 37,00 B	TR24130	 29,90 B
TR22531	 28,80 B	<b>ADAPTATEUR MECANIQUE</b>		TR24131	 29,90 B
<b>CONNEXION ELECTRIQUE</b>		TR23330	 32 67 13,40 B		
TR22630	 21 68 52 9,30 B	TR23331	 13,40 B		
TR22631	 9,30 B	<b>ADAPTATEUR 10A MAX 5KG</b>			
<b>CONNEXION MECANIQUE</b>		TR23430	 39 70 12,40 B		
TR22730	 20 66 7,30 B	TR23431	 12,40 B		
TR22731	 7,30 B	<b>CROCHET DE SUSPENSION</b>			
<b>CONNEXION L 90° INTERIEURE</b>		TR24030	 25 52 2,10 B		
TR22830	 101 67 28,80 B	TR24031	 2,10 B		
TR22831	 28,80 B	<b>KIT FIXATION PLAFOND</b>			
<b>CONNEXION L 90° EXTERIEURE</b>		TR23530	 34 40 13 5,20 B		
TR22930	 101 67 28,80 B	TR23531	 5,20 B		
TR22931	 29,90 B	<b>KIT SUSPENSION L:500cm</b>			
<b>CONNEXION EN CROIX</b>		TR23630	 35 40 22,70 B		
TR23030	 100 166 49,40 B	TR23631	 21,60 B		
TR23031	 49,40 B	<b>PIECE DE RENFORT L:18cm</b>			
<b>CONNEXION T DROITE</b>		TR23930	 21 182 11,30 B		
TR23130	 101 166 42,20 B	TR23931	 11,30 B		

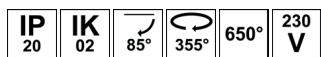

## YERA GU10

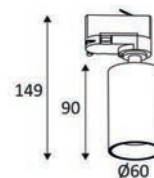

- Projecteur pour éclairage d'accentuation.
- Adaptateur pour Track III SURFACE.
- Base apparente TR241 à commander séparément.



YERA GU10		MATIÈRE	SOCKET	LAMP	Watt Max	€
TR35905	NOIR MAT	ALUMINIUM	GU10	PAR16	10W	52,50 B
TR35930	BLANC MAT	ALUMINIUM	GU10	PAR16	10W	52,50 B

ACCESSOIRES		DESCRIPTION		€
TR24130	NOIR	BASE APPARENTE		29,90 B
TR24131	BLANC	BASE APPARENTE		29,90 B



NOIR MAT

BLANC MAT





## OKTO 3 T GU10

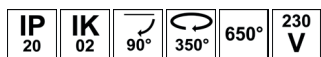

- Projecteur pour éclairage d'accentuation.
- Adaptateur pour Track III SURFACE.
- Base apparente TR241 à commander séparément.

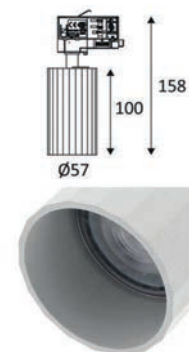

OKTO 3 T GU10		MATIÈRE	SOCKET	LAMP	Watt Max	€
TR42205		NOIR MAT	ALUMINIUM	GU10	PAR16 LED	10W 52,50 B
TR42208		NOIR MAT - CHAMPAGNE	ALUMINIUM	GU10	PAR16 LED	10W 58,70 B
TR42206		NOIR MAT - OR ROSE	ALUMINIUM	GU10	PAR16 LED	10W 58,70 B
TR42283		NOIR MAT - ROSE	ALUMINIUM	GU10	PAR16 LED	10W 58,70 B
TR42230		BLANC MAT	ALUMINIUM	GU10	PAR16 LED	10W 52,50 B
TR42249		BLANC MAT - CHAMPAGNE	ALUMINIUM	GU10	PAR16 LED	10W 58,70 B
TR42202		BLANC MAT - OR ROSE	ALUMINIUM	GU10	PAR16 LED	10W 58,70 B
TR42282		BLANC MAT - ROSE	ALUMINIUM	GU10	PAR16 LED	10W 58,70 B

ACCESSOIRES		DESCRIPTION	€
TR24130	NOIR	BASE APPARENTE	29,90 B
TR24131	BLANC	BASE APPARENTE	29,90 B



NOIR MAT    NOIR MAT - CHAMPAGNE    NOIR MAT - OR ROSE    NOIR MAT - ROSE    BLANC MAT    BLANC MAT - CHAMPAGNE    BLANC MAT - OR ROSE    BLANC MAT - ROSE





## OKTO 3 TP GU10

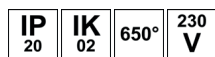

- Suspension décorative.
- Adaptateur pour Track III SURFACE.
- Livrée avec câble d'alimentation textile (réglable 1.50m max).  
Coloris 05 - 08 - 06 - 83 : câble noir.  
Coloris 30 - 49 - 02 - 82 : câble blanc.

OKTO 3 TP GU10		MATIÈRE	SOCKET	LAMP	Watt Max	€
TR42305	NOIR MAT	ALUMINIUM	GU10	PAR16 LED	10W	67,00 B
TR42308	NOIR MAT - CHAMPAGNE	ALUMINIUM	GU10	PAR16 LED	10W	82,40 B
TR42306	NOIR MAT - OR ROSE	ALUMINIUM	GU10	PAR16 LED	10W	82,40 B
TR42383	NOIR MAT - ROSE	ALUMINIUM	GU10	PAR16 LED	10W	82,40 B
TR42330	BLANC MAT	ALUMINIUM	GU10	PAR16 LED	10W	69,00 B
TR42349	BLANC MAT - CHAMPAGNE	ALUMINIUM	GU10	PAR16 LED	10W	82,40 B
TR42302	BLANC MAT - OR ROSE	ALUMINIUM	GU10	PAR16 LED	10W	82,40 B
TR42382	BLANC MAT - ROSE	ALUMINIUM	GU10	PAR16 LED	10W	82,40 B



### AUREA 3 T

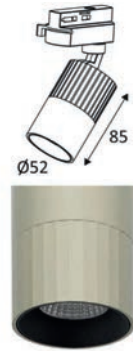
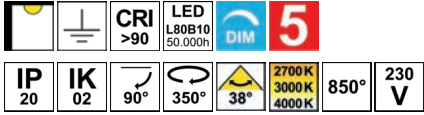

- Projecteur pour éclairage d'accentuation.
- Adaptateur pour Track III SURFACE.
- 2700K, 3000K ou 4000K au choix via un interrupteur à l'arrière du luminaire.
- Convertisseur dimmable intégré dans l'appareil.
- Compatible avec variateur début de phase.
- Réserver une phase spécifique du rail pour les produits dimmables.
- Base apparente TR241 à commander séparément.

AUREA 3 T	MATIÈRE	LED	T°	LED Lumen	System Lumen	€
TR43305	NOIR MAT	ALUMINIUM	6W	2700-3000-4000K	715 Lm (4000K) 550 Lm (4000K)	81,40 B
TR43308	NOIR MAT - CHAMPAGNE	ALUMINIUM	6W	2700-3000-4000K	715 Lm (4000K) 550 Lm (4000K)	81,40 B
TR43383	NOIR MAT - ROSE	ALUMINIUM	6W	2700-3000-4000K	715 Lm (4000K) 550 Lm (4000K)	97,90 B
TR43330	BLANC MAT	ALUMINIUM	6W	2700-3000-4000K	715 Lm (4000K) 550 Lm (4000K)	81,40 B
TR43349	BLANC MAT - CHAMPAGNE	ALUMINIUM	6W	2700-3000-4000K	715 Lm (4000K) 550 Lm (4000K)	97,90 B
TR43382	BLANC MAT - ROSE	ALUMINIUM	6W	2700-3000-4000K	715 Lm (4000K) 550 Lm (4000K)	97,90 B

**ACCESSOIRES** DESCRIPTION €

TR24130	NOIR	BASE APPARENTE		29,90 B
TR24131	BLANC	BASE APPARENTE		29,90 B



### AUREA 3 TP

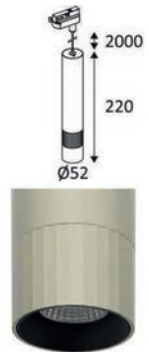
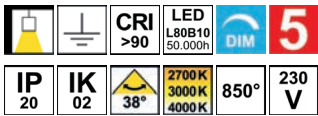

- Suspension décorative.
- Adaptateur pour Track III SURFACE.
- Livrée avec câble d'alimentation (réglable 2.00m max).  
Coloris 05 - 08 - 83 : câble noir.  
Coloris 30 - 49 - 82 : câble blanc.
- 2700K, 3000K ou 4000K au choix via un interrupteur à l'arrière du luminaire.
- Convertisseur dimmable intégré dans l'appareil.
- Compatible avec variateur début de phase.
- Réserver une phase spécifique du rail pour les produits dimmables.

AUREA 3 TP	MATIÈRE	LED	T°	LED Lumen	System Lumen	€
TR43405	NOIR MAT	ALUMINIUM	6W	2700-3000-4000K	715 Lm (4000K) 550 Lm (4000K)	120,50 B
TR43408	NOIR MAT - CHAMPAGNE	ALUMINIUM	6W	2700-3000-4000K	715 Lm (4000K) 550 Lm (4000K)	131,80 B
TR43483	NOIR MAT - ROSE	ALUMINIUM	6W	2700-3000-4000K	715 Lm (4000K) 550 Lm (4000K)	131,80 B
TR43430	BLANC MAT	ALUMINIUM	6W	2700-3000-4000K	715 Lm (4000K) 550 Lm (4000K)	120,50 B
TR43449	BLANC MAT - CHAMPAGNE	ALUMINIUM	6W	2700-3000-4000K	715 Lm (4000K) 550 Lm (4000K)	131,80 B
TR43482	BLANC MAT - ROSE	ALUMINIUM	6W	2700-3000-4000K	715 Lm (4000K) 550 Lm (4000K)	131,80 B

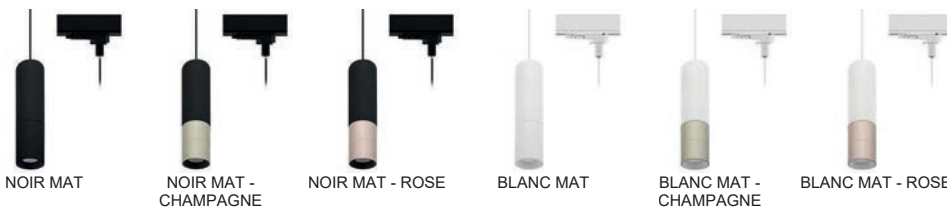





## JIMY 2

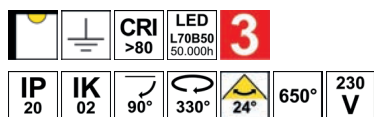

- Projecteur pour éclairage d'accentuation.
- Adaptateur pour Track III SURFACE.
- Convertisseur non dimmable intégré dans l'appareil.
- Base apparente TR241 à commander séparément.



JIMY 2		MATIÈRE	LED	T°	LED Lumen	System Lumen	€
TR131SW05	NOIR	FONTA D'ALUMINIUM	8W	2700K	750 Lm	650 Lm	89,60 B
TR131SW30	BLANC	FONTA D'ALUMINIUM	8W	2700K	750 Lm	650 Lm	89,60 B
TR131WW05	NOIR	FONTA D'ALUMINIUM	8W	3000K	800 Lm	732 Lm	89,60 B
TR131WW30	BLANC	FONTA D'ALUMINIUM	8W	3000K	800 Lm	732 Lm	89,60 B
TR131NW05	NOIR	FONTA D'ALUMINIUM	8W	4000K	850 Lm	779 Lm	89,60 B
TR131NW30	BLANC	FONTA D'ALUMINIUM	8W	4000K	850 Lm	779 Lm	89,60 B

ACCESSOIRES		DESCRIPTION	€
TR24130	NOIR	BASE APPARENTE	29,90 B
TR24131	BLANC	BASE APPARENTE	29,90 B



NOIR

BLANC





# HALO

		<b>CRI &gt;90</b>	<b>LED L70B50 50.000h</b>	<b>3</b>
<b>IP 20</b>	<b>IK 02</b>	<b>90°</b>	<b>330°</b>	<b>650°</b>
				<b>230 V</b>



- Projecteur pour éclairage d'accentuation.
- Adaptateur pour Track III SURFACE.
- Convertisseur non dimmable intégré dans l'appareil.
- Base apparente TR241 à commander séparément.

HALO		MATIÈRE	LED	T°	LED Lumen	System Lumen	α	€	
			24°						
TR153WW05		NOIR	FONTE D'ALUMINIUM	20W	3000K	2000 Lm	1470 Lm	24°	145,20 B
TR153WW30		BLANC	FONTE D'ALUMINIUM	20W	3000K	2000 Lm	1470 Lm	24°	145,20 B
TR153NW05		NOIR	FONTE D'ALUMINIUM	20W	4000K	2100 Lm	1635 Lm	24°	145,20 B
TR153NW30		BLANC	FONTE D'ALUMINIUM	20W	4000K	2100 Lm	1635 Lm	24°	145,20 B
			40°						
TR152WW05		NOIR	FONTE D'ALUMINIUM	20W	3000K	2000 Lm	1422 Lm	40°	145,20 B
TR152WW30		BLANC	FONTE D'ALUMINIUM	20W	3000K	2000 Lm	1422 Lm	40°	145,20 B
TR152NW05		NOIR	FONTE D'ALUMINIUM	20W	4000K	2100 Lm	1575 Lm	40°	145,20 B
TR152NW30		BLANC	FONTE D'ALUMINIUM	20W	4000K	2100 Lm	1575 Lm	40°	145,20 B

ACCESSOIRES		DESCRIPTION		€
TR24130	NOIR	BASE APPARENTE		29,90 B
TR24131	BLANC	BASE APPARENTE		29,90 B



NOIR

BLANC



## HELLO 1 D

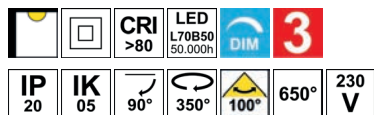

- Projecteur pour éclairage diffus.
- Adaptateur pour Track III SURFACE.
- Convertisseur dimmable intégré dans l'appareil.
- Compatible avec variateur fin de phase.
- Réserver une phase spécifique du rail pour les produits dimmables.

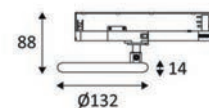

HELLO 1 D	MATÉRIE	LED	T°	LED Lumen	System Lumen	€	
TR389WW05	NOIR MAT	ALUMINIUM	10W	3000K	1300 Lm	825 Lm	138,00 B
TR389WW30	BLANC MAT	ALUMINIUM	10W	3000K	1300 Lm	825 Lm	138,00 B



NOIR MAT

BLANC MAT

## HELLO 2 D

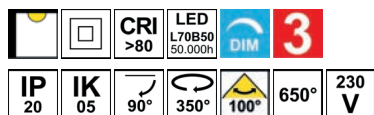

- Projecteur pour éclairage diffus.
- Adaptateur pour Track III SURFACE.
- Convertisseur dimmable intégré dans l'appareil.
- Compatible avec variateur fin de phase.
- Réserver une phase spécifique du rail pour les produits dimmables.

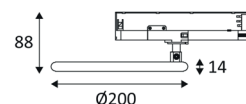

HELLO 2 D	MATÉRIE	LED	T°	LED Lumen	System Lumen	€	
TR390WW05	NOIR MAT	ALUMINIUM	17W	3000K	2160 Lm	1740 Lm	191,60 B
TR390WW30	BLANC MAT	ALUMINIUM	17W	3000K	2160 Lm	1740 Lm	191,60 B



NOIR MAT

BLANC MAT







## OSIS 1

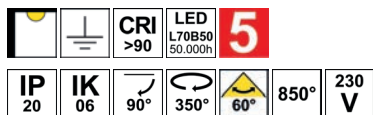

- Projecteur pour éclairage d'accentuation.
- Adaptateur pour Track III SURFACE.
- Convertisseur non dimmable intégré dans l'appareil.

OSIS 1	MATÉRIE	LED	T°	LED Lumen	System Lumen	€	
TR370WW05	NOIR MAT	FONTE D'ALUMINIUM	25W	3000K	2600 Lm	1783 Lm	110,20 B
TR370WW30	BLANC MAT	FONTE D'ALUMINIUM	25W	3000K	2600 Lm	2002 Lm	110,20 B
TR370NW05	NOIR MAT	FONTE D'ALUMINIUM	25W	4000K	2700 Lm	1791 Lm	110,20 B
TR370NW30	BLANC MAT	FONTE D'ALUMINIUM	25W	4000K	2700 Lm	2086 Lm	110,20 B



NOIR MAT

BLANC MAT

## OSIS 1 PLUS

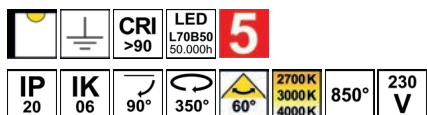

- Projecteur pour éclairage d'accentuation.
- Adaptateur pour Track III SURFACE.
- 2700K, 3000K ou 4000K au choix via un interrupteur sur l'adaptateur.
- Convertisseur non dimmable intégré dans l'appareil.

OSIS 1 PLUS	MATÉRIE	LED	T°	LED Lumen	System Lumen	€	
TR43805 <b>NEW</b>	NOIR MAT	FONTE D'ALUMINIUM	25W	2700-3000-4000K	3200 Lm (4000K)	2100 Lm (4000K)	88,70 A
TR43830 <b>NEW</b>	BLANC MAT	FONTE D'ALUMINIUM	25W	2700-3000-4000K	3200 Lm (4000K)	2210 Lm (4000K)	88,70 A



NOIR MAT

BLANC MAT

NEW

## OSIS 2

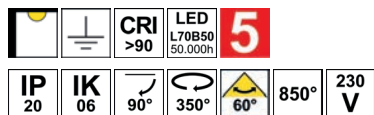

- Projecteur pour éclairage d'accentuation.
- Adaptateur pour Track III SURFACE.
- Convertisseur non dimmable intégré dans l'appareil.

OSIS 2	MATIERE	LED	T°	LED Lumen	System Lumen	€	
TR371WW05	NOIR MAT	FONTE D'ALUMINIUM	40W	3000K	4400 Lm	2360 Lm	139,10 B
TR371WW30	BLANC MAT	FONTE D'ALUMINIUM	40W	3000K	4400 Lm	2985 Lm	139,10 B
TR371NW05	NOIR MAT	FONTE D'ALUMINIUM	40W	4000K	4700 Lm	2840 Lm	139,10 B
TR371NW30	BLANC MAT	FONTE D'ALUMINIUM	40W	4000K	4700 Lm	3617 Lm	139,10 B



NOIR MAT

BLANC MAT

## OSIS 2 PLUS

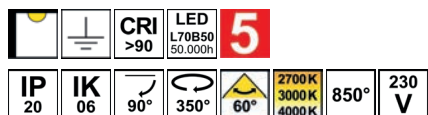

- Projecteur pour éclairage d'accentuation.
- Adaptateur pour Track III SURFACE.
- 2700K, 3000K ou 4000K au choix via un interrupteur sur l'adaptateur.
- Convertisseur non dimmable intégré dans l'appareil.

OSIS 2 PLUS	MATIERE	LED	T°	LED Lumen	System Lumen	€	
TR43905 <b>NEW</b>	NOIR MAT	FONTE D'ALUMINIUM	40W	2700-3000-4000K	5250 Lm (4000K)	3420 Lm (4000K)	106,70 A
TR43930 <b>NEW</b>	BLANC MAT	FONTE D'ALUMINIUM	40W	2700-3000-4000K	5250 Lm (4000K)	4000 Lm (4000K)	106,70 A



NOIR MAT

BLANC MAT





**TED**

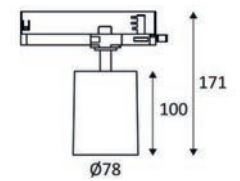
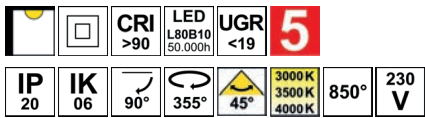

- Projecteur pour éclairage d'accentuation.
- Adaptateur pour Track III SURFACE.
- 3000K, 3500K ou 4000K au choix via un interrupteur à l'arrière du luminaire.
- Convertisseur non dimmable intégré dans l'appareil.

TED	MATÉRIE	LED	T°	LED Lumen	System Lumen	€
TR43505	■ NOIR MAT ALUMINIUM	28W	3000-3500-4000K	3000 Lm (4000K)	2140 Lm (4000K)	117,40 B
TR43530	■ BLANC MAT ALUMINIUM	28W	3000-3500-4000K	3000 Lm (4000K)	2140 Lm (4000K)	117,40 B



NOIR MAT

BLANC MAT





### FOCAL

		<b>CRI &gt;90</b>	<b>LED L80B10 50.000h</b>	<b>UGR &lt;19</b>	<b>5</b>
<b>IP 20</b>	<b>IK 06</b>	<b>90°</b>	<b>355°</b>	<b>30-60°</b>	<b>3000K 3500K 4000K</b>
					<b>850°</b>
					<b>230 V</b>

- Projecteur pour éclairage d'accentuation.
- Adaptateur pour Track III SURFACE.
- 3000K, 3500K ou 4000K au choix via un interrupteur à l'arrière du luminaire.
- Faisceau ajustable de 30° à 60°.
- Convertisseur non dimmable intégré dans l'appareil.

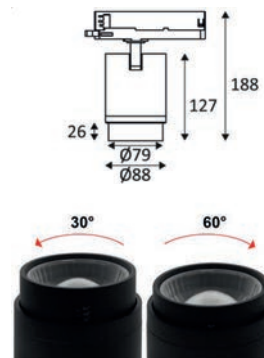

FOCAL	MATIERE	LED	T°	LED Lumen	System Lumen	€
TR43705	NOIR MAT	ALUMINIUM	32W 3000-3500-4000K	3550 Lm (4000K)	2535 Lm (4000K)	140,10 B
TR43730	BLANC MAT	ALUMINIUM	32W 3000-3500-4000K	3550 Lm (4000K)	2535 Lm (4000K)	140,10 B



NOIR MAT



BLANC MAT





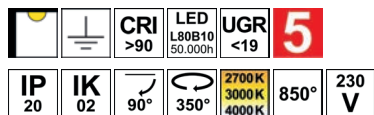

## FOCUS



- Projecteur pour éclairage d'accentuation.
- Adaptateur pour Track III SURFACE.
- 2700K, 3000K ou 4000K au choix via un interrupteur à l'arrière du luminaire.
- Faisceau ajustable de 15° à 35° (TR393), ou de 35° à 60° (TR394).
- Convertisseur non dimmable intégré dans l'appareil.
- Base apparente TR241 à commander séparément.



FOCUS	MATIÈRE	LED	T°	LED Lumen	System Lumen	α	€	
			15-35°					
TR39305	■ NOIR MAT	ALUMINIUM	35W	2700-3000-4000K	2815 Lm (4000K)	2430 Lm (4000K)	15-35°	218,40 B
TR39330	■ BLANC MAT	ALUMINIUM	35W	2700-3000-4000K	2815 Lm (4000K)	2430 Lm (4000K)	15-35°	218,40 B
			35-60°					
TR39405	■ NOIR MAT	ALUMINIUM	35W	2700-3000-4000K	2815 Lm (4000K)	2645 Lm (4000K)	35-60°	218,40 B
TR39430	■ BLANC MAT	ALUMINIUM	35W	2700-3000-4000K	2815 Lm (4000K)	2645 Lm (4000K)	35-60°	218,40 B

ACCESSOIRES	DESCRIPTION	€	
TR24130	NOIR	BASE APPARENTE	 29,90 B
TR24131	BLANC	BASE APPARENTE	 29,90 B



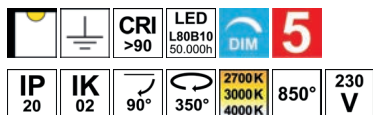

## JACK 3 T



- Projecteur pour éclairage d'accentuation.
- Adaptateur pour Track III SURFACE.
- 2700K, 3000K ou 4000K au choix via un interrupteur à l'arrière du luminaire.
- Convertisseur dimmable intégré dans l'appareil.
- Compatible avec variateur fin de phase.
- Réserver une phase spécifique du rail pour les produits dimmables.
- Base apparente TR241 à commander séparément.

JACK 3 T	MATIÈRE	LED	T°	LED Lumen	System Lumen	α	€
<b>40°</b>							
TR42405	NOIR MAT	ALUMINIUM	30W	2700-3000-4000K	3310 Lm (4000K)	2700 Lm (4000K)	40° 213,20 B
TR42413	NOIR MAT - LAITON	ALUMINIUM	30W	2700-3000-4000K	3310 Lm (4000K)	2700 Lm (4000K)	40° 217,30 B
TR42406	NOIR MAT - OR ROSE	ALUMINIUM	30W	2700-3000-4000K	3310 Lm (4000K)	2700 Lm (4000K)	40° 242,10 B
TR42430	BLANC MAT	ALUMINIUM	30W	2700-3000-4000K	3310 Lm (4000K)	2700 Lm (4000K)	40° 213,20 B
TR42428	BLANC MAT - LAITON	ALUMINIUM	30W	2700-3000-4000K	3310 Lm (4000K)	2700 Lm (4000K)	40° 242,10 B
TR42402	BLANC MAT - OR ROSE	ALUMINIUM	30W	2700-3000-4000K	3310 Lm (4000K)	2700 Lm (4000K)	40° 242,10 B
<b>60°</b>							
TR42505	NOIR MAT	ALUMINIUM	30W	2700-3000-4000K	3310 Lm (4000K)	2615 Lm (4000K)	60° 213,20 B
TR42513	NOIR MAT - LAITON	ALUMINIUM	30W	2700-3000-4000K	3310 Lm (4000K)	2615 Lm (4000K)	60° 242,10 B
TR42506	NOIR MAT - OR ROSE	ALUMINIUM	30W	2700-3000-4000K	3310 Lm (4000K)	2615 Lm (4000K)	60° 242,10 B
TR42530	BLANC MAT	ALUMINIUM	30W	2700-3000-4000K	3310 Lm (4000K)	2615 Lm (4000K)	60° 213,20 B
TR42528	BLANC MAT - LAITON	ALUMINIUM	30W	2700-3000-4000K	3310 Lm (4000K)	2615 Lm (4000K)	60° 242,10 B
TR42502	BLANC MAT - OR ROSE	ALUMINIUM	30W	2700-3000-4000K	3310 Lm (4000K)	2615 Lm (4000K)	60° 242,10 B

ACCESSOIRES	DESCRIPTION	€	
TR24130	NOIR	BASE APPARENTE	 29,90 B
TR24131	BLANC	BASE APPARENTE	 29,90 B





## JACK 3 TP

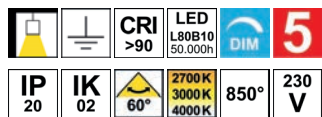

- Suspension décorative.
- Adaptateur pour Track III SURFACE.
- Livrée avec câble d'alimentation textile (réglable 1.60m max).  
Coloris 05 - 13 - 06 : câble noir.  
Coloris 30 - 28 - 02 : câble blanc.
- 2700K, 3000K ou 4000K au choix via un interrupteur à l'arrière du luminaire.
- Convertisseur dimmable intégré dans l'appareil.
- Compatible avec variateur fin de phase.
- Réserver une phase spécifique du rail pour les produits dimmables.

JACK 3 TP		MATIÈRE	LED	T°	LED Lumen	System Lumen	€		
TR42605		NOIR MAT	ALUMINIUM	25W	2700-3000-4000K	2810 Lm (4000K)	2270 Lm (4000K)	202,90	B
TR42613		NOIR MAT - LAITON	ALUMINIUM	25W	2700-3000-4000K	2810 Lm (4000K)	2270 Lm (4000K)	236,90	B
TR42606		NOIR MAT - OR ROSE	ALUMINIUM	25W	2700-3000-4000K	2810 Lm (4000K)	2270 Lm (4000K)	236,90	B
TR42630		BLANC MAT	ALUMINIUM	25W	2700-3000-4000K	2810 Lm (4000K)	2270 Lm (4000K)	202,90	B
TR42628		BLANC MAT - LAITON	ALUMINIUM	25W	2700-3000-4000K	2810 Lm (4000K)	2270 Lm (4000K)	236,90	B
TR42602		BLANC MAT - OR ROSE	ALUMINIUM	25W	2700-3000-4000K	2810 Lm (4000K)	2270 Lm (4000K)	236,90	B









## LIMA 1 PLUS

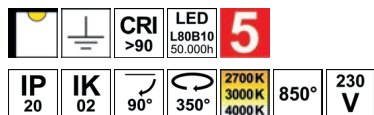

- Projecteur pour éclairage d'accentuation.
- Adaptateur pour Track III SURFACE.
- 2700K, 3000K ou 4000K au choix via un interrupteur à l'arrière du luminaire.
- Convertisseur non dimmable intégré dans l'appareil.
- Utiliser les verres pour alimentation avec la température de couleur 3000K.
- Base apparente TR241 à commander séparément.

LIMA 1 PLUS	MATIÈRE	LED	T°	LED Lumen	System Lumen	α	€	
		40°						
TR39505	■ NOIR MAT	ALUMINIUM	25W	2700-3000-4000K	2550 Lm (4000K)	1760 Lm (4000K)	40°	157,60 B
TR39530	■ BLANC MAT	ALUMINIUM	25W	2700-3000-4000K	2550 Lm (4000K)	1920 Lm (4000K)	40°	157,60 B
		60°						
TR39605	■ NOIR MAT	ALUMINIUM	25W	2700-3000-4000K	2550 Lm (4000K)	1760 Lm (4000K)	60°	157,60 B
TR39630	■ BLANC MAT	ALUMINIUM	25W	2700-3000-4000K	2550 Lm (4000K)	1920 Lm (4000K)	60°	157,60 B

ACCESSOIRES	DESCRIPTION	€
TR32105	■ NOIR GRILLE NID D'ABEILLE DIA.71mm	5,20 B
TR32432	■ VERRE ALIMENTATION DIA.71mm	27,80 B
TR32756	■ VERRE ALIMENTATION DIA.71mm	27,80 B
TR33058	■ FILTRE LAME DE LUMIERE DIA.71mm	4,10 B
TR38505	■ NOIR MAT VOLET COUPE FLUX DIA.71mm	19,60 B
TR38530	■ BLANC MAT VOLET COUPE FLUX DIA.71mm	19,60 B
TR24130	■ NOIR BASE APPARENTE	29,90 B
TR24131	■ BLANC BASE APPARENTE	29,90 B

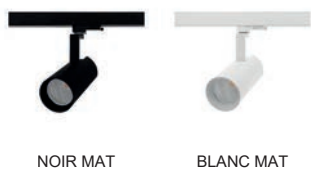

NOIR MAT

BLANC MAT

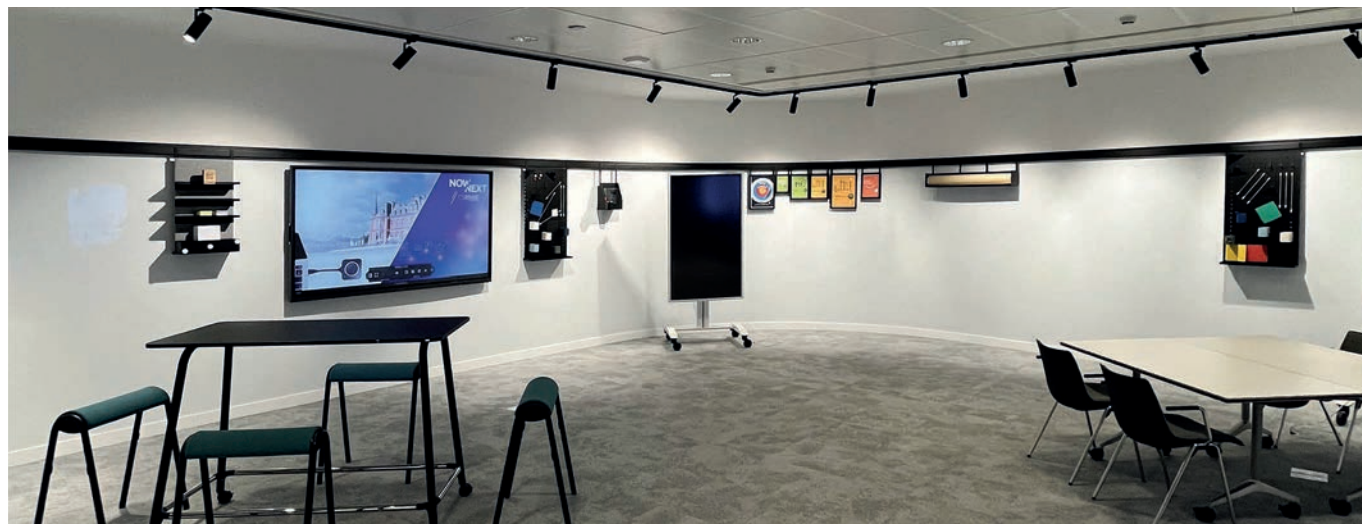

## LIMA 2 PLUS



- Projecteur pour éclairage d'accentuation.
- Adaptateur pour Track III SURFACE.
- 2700K, 3000K ou 4000K au choix via un interrupteur à l'arrière du luminaire.
- Convertisseur non dimmable intégré dans l'appareil.
- Utiliser les verres pour alimentation avec la température de couleur 3000K.
- Base apparente TR241 à commander séparément.

LIMA 2 PLUS	MATIÈRE	LED	T°	LED Lumen	System Lumen	α	€
		40°					
TR39705	■ NOIR MAT	ALUMINIUM	35W	2700-3000-4000K	4230 Lm (4000K)	2335 Lm (4000K)	40° 178,20 B
TR39730	■ BLANC MAT	ALUMINIUM	35W	2700-3000-4000K	4230 Lm (4000K)	2675 Lm (4000K)	40° 178,20 B
		60°					
TR39805	■ NOIR MAT	ALUMINIUM	35W	2700-3000-4000K	4230 Lm (4000K)	2545 Lm (4000K)	60° 178,20 B
TR39830	■ BLANC MAT	ALUMINIUM	35W	2700-3000-4000K	4230 Lm (4000K)	2685 Lm (4000K)	60° 178,20 B

ACCESSOIRES	DESCRIPTION	€
TR32205	■ NOIR GRILLE NID D'ABEILLE DIA.83mm	6,20 B
TR32532	■ VERRE ALIMENTATION DIA.83mm	28,80 B
TR32856	■ VERRE ALIMENTATION DIA.83mm	28,80 B
TR33158	■ FILTRE LAME DE LUMIERE DIA.83mm	4,10 B
TR38605	■ NOIR MAT VOLET COUPE FLUX DIA.83mm	21,60 B
TR38630	■ BLANC MAT VOLET COUPE FLUX DIA.83mm	21,60 B
TR24130	■ NOIR BASE APPARENTE	29,90 B
TR24131	■ BLANC BASE APPARENTE	29,90 B





## LIMA 3 PLUS

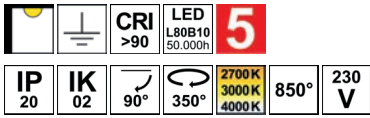

- Projecteur pour éclairage d'accentuation.
- Adaptateur pour Track III SURFACE.
- 2700K, 3000K ou 4000K au choix via un interrupteur à l'arrière du luminaire.
- Convertisseur non dimmable intégré dans l'appareil.
- Utiliser les verres pour alimentation avec la température de couleur 3000K.
- Base apparente TR241 à commander séparément.

LIMA 3 PLUS	MATIÈRE	LED	T°	LED Lumen	System Lumen	α	€	
		40°						
TR39905	■ NOIR MAT	ALUMINIUM	55W	2700-3000-4000K	4925 Lm (4000K)	3625 Lm (4000K)	40°	219,40 B
TR39930	■ BLANC MAT	ALUMINIUM	55W	2700-3000-4000K	4925 Lm (4000K)	3960 Lm (4000K)	40°	219,40 B
		60°						
TR40005	■ NOIR MAT	ALUMINIUM	55W	2700-3000-4000K	4925 Lm (4000K)	3615 Lm (4000K)	60°	219,40 B
TR40030	■ BLANC MAT	ALUMINIUM	55W	2700-3000-4000K	4925 Lm (4000K)	3875 Lm (4000K)	60°	219,40 B

ACCESSOIRES	DESCRIPTION	€
TR32305	■ NOIR GRILLE NID D'ABEILLE DIA.100mm	7,20 B
TR32632	■ VERRE ALIMENTATION DIA.100mm	31,90 B
TR32956	■ VERRE ALIMENTATION DIA.100mm	31,90 B
TR33258	■ FILTRE LAME DE LUMIERE DIA.100mm	5,20 B
TR38705	■ NOIR MAT VOILET COUPE FLUX DIA.100mm	24,70 B
TR38730	■ BLANC MAT VOILET COUPE FLUX DIA.100mm	24,70 B
TR24130	■ NOIR BASE APPARENTE	29,90 B
TR24131	■ BLANC BASE APPARENTE	29,90 B



NOIR MAT

BLANC MAT



## LINEA 1

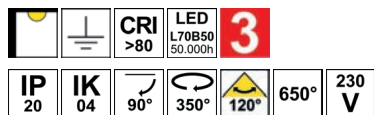

- Structure linéaire pour éclairage diffus.
- Adaptateur pour Track III SURFACE.
- Convertisseur non dimmable intégré dans l'appareil.
- Grille nid d'abeille en option.

LINEA 1	MATIÈRE	LED	T°	LED Lumen	System Lumen	€
TR357WW05	NOIR	ALUMINIUM	3000K	3750 lm	3188 Lm	229,70 B
TR357WW30	BLANC	ALUMINIUM	3000K	3750 lm	3188 Lm	229,70 B
TR357NW05	NOIR	ALUMINIUM	4000K	3900 Lm	3269 Lm	229,70 B
TR357NW30	BLANC	ALUMINIUM	4000K	3900 Lm	3269 Lm	229,70 B

ACCESSOIRES	DESCRIPTION	€
TR38805	NOIR GRILLE NID D'ABEILLE 665X35mm	5,20 B



NOIR

BLANC

## LINEA 2

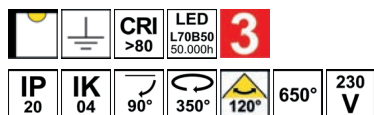

- Structure linéaire pour éclairage diffus.
- Adaptateur pour Track III SURFACE.
- Convertisseur non dimmable intégré dans l'appareil.
- Grille nid d'abeille en option.

LINEA 2	MATIÈRE	LED	T°	LED Lumen	System Lumen	€
TR358WW05	NOIR	ALUMINIUM	3000K	2x3750 Lm	2x3188 Lm	346,10 B
TR358WW30	BLANC	ALUMINIUM	3000K	2x3750 Lm	2x3188 Lm	346,10 B
TR358NW05	NOIR	ALUMINIUM	4000K	2x3900 Lm	2x3269 Lm	346,10 B
TR358NW30	BLANC	ALUMINIUM	4000K	2x3900 Lm	2x3269 Lm	346,10 B

ACCESSOIRES	DESCRIPTION	€
TR38805	NOIR GRILLE NID D'ABEILLE 665X35mm	5,20 B

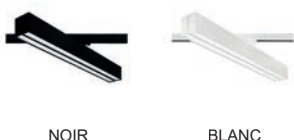

NOIR

BLANC

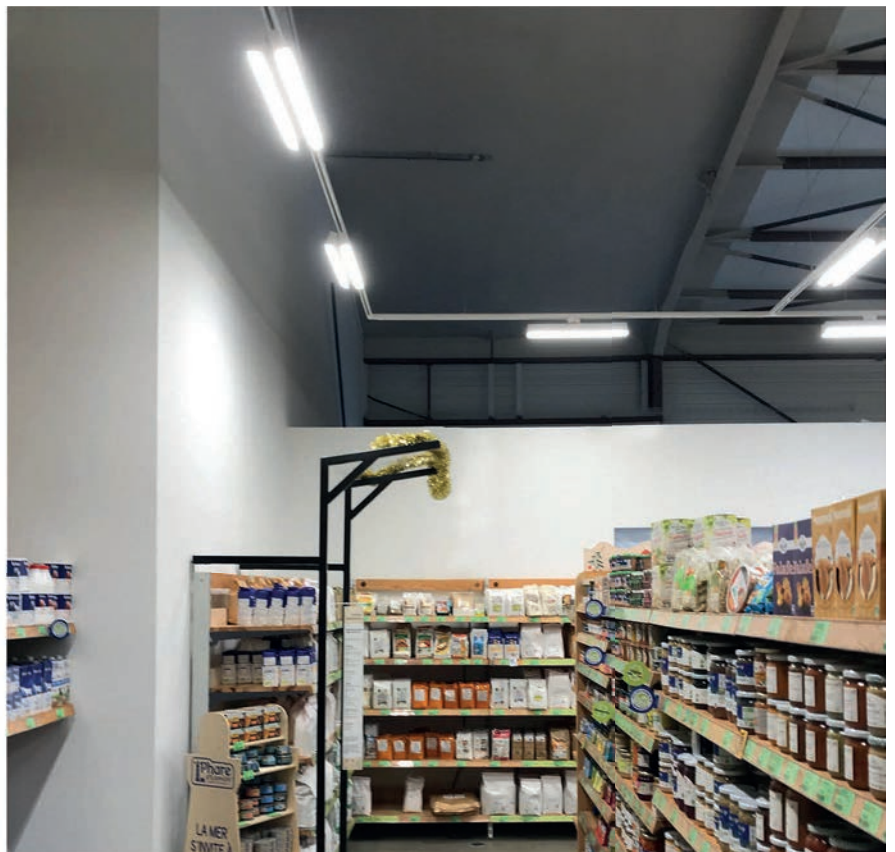
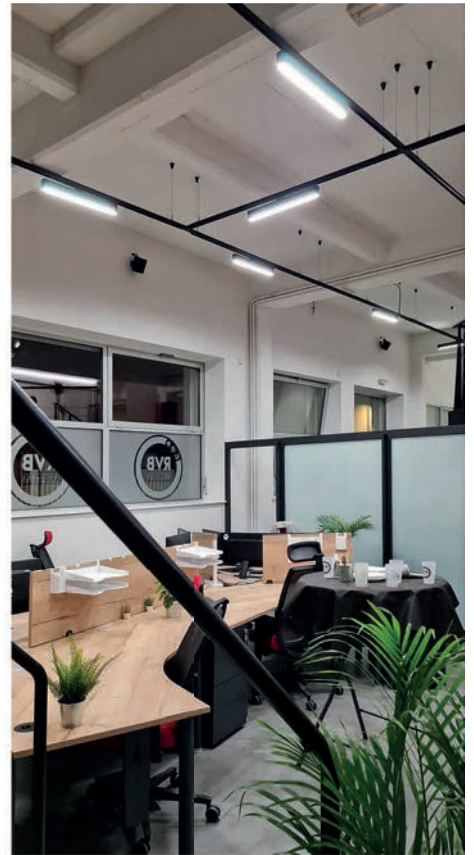

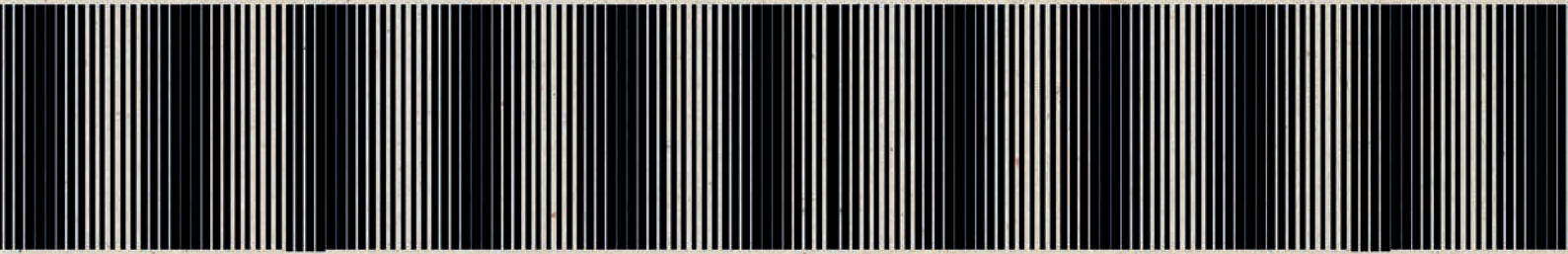

# INDIGO



LIGHTING



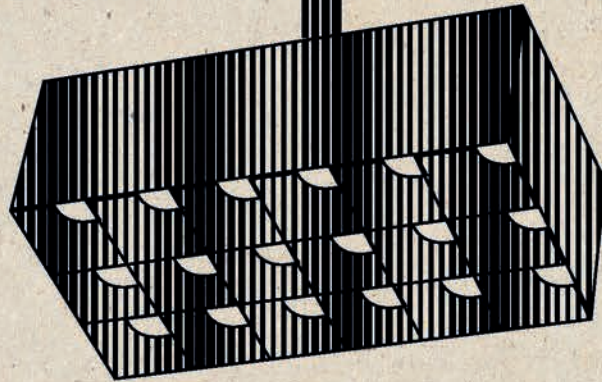
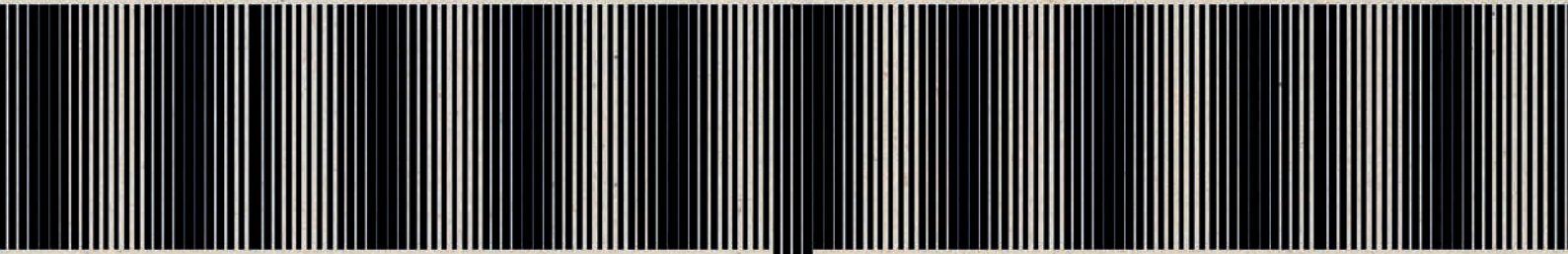

**RAILS & PROJECTEURS**  
**ARCHITECTURAUX**







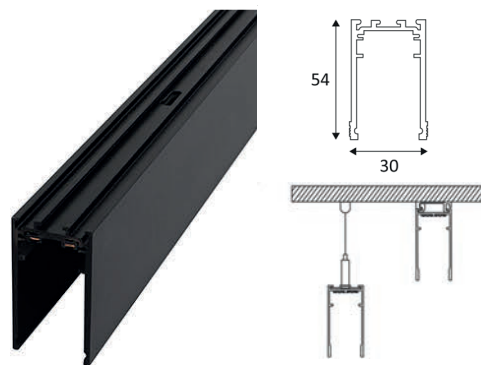



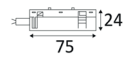



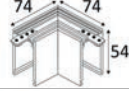





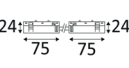



## TRACK 48VDC SURFACE



- Rail apparent 48Vdc.
- Convertisseur à commander séparément.
- Le convertisseur peut être déporté ou inclus dans le rail en utilisant un boîtier prévu à cet effet (TR25005 + CD144 ou TR37505).
- Max. 20m et 400W en ligne continue.

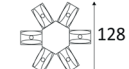

TRACK 48VDC SURFACE			MATIÈRE	L (mm)	€
TR24005	■ NOIR MAT	MATT BLACK	ALUMINIUM	1000	78,30 B
TR24105	■ NOIR MAT	MATT BLACK	ALUMINIUM	2000	155,50 B
TR24205	■ NOIR MAT	MATT BLACK	ALUMINIUM	3000	232,80 B

ACCESSOIRES		DESCRIPTION	ALIMENTATION	€
TR24605	NOIR MAT	ALIMENTATION + CABLE 150cm	 	41,20 B
<b>CONNECTEURS</b>				
TR24805	METAL	CONNEXION MECANIQUE	 	7,20 B
TR24705	NOIR MAT	CONNEXION ELECTRIQUE		15,50 B
TR24305	NOIR MAT	CONNEXION L 90° PLAFOND AVEC TR24805	 	16,50 B
TR24405	NOIR MAT	CONNEXION L 90° MUR INT AVEC TR24805	 	16,50 B
TR24505	NOIR MAT	CONNEXION L 90° MUR EXT AVEC TR24805	 	16,50 B
TR24905	NOIR MAT	CONNEXION ELEC + CABLE POUR TR243/244/245 TR263/264/265	 	40,20 B
TR36505	NOIR MAT	CONNEXION ELEC L 90° INTERIEUR PLAFOND	 	38,10 B
TR36605	NOIR MAT	CONNEXION ELEC T GAUCHE PLAFOND	 	47,40 B
TR36705	NOIR MAT	CONNEXION ELEC T DROITE PLAFOND	 	47,40 B
TR36805	NOIR MAT	CONNEXION ELEC X PLAFOND	 	50,50 B
TR37205	NOIR MAT	CONNEXION ELEC DOUBLE 120° PLAFOND	 	41,20 B
TR37305	NOIR MAT	CONNEXION ELEC TRIPLE 120° PLAFOND	 	45,30 B
TR37405	NOIR MAT	CONNEXION MECANIQUE MULTIPLE PLAFOND	 	173,00 B





ACCESSOIRES		DESCRIPTION		€
<b>CONVERTISSEURS</b>				
TR25005	NOIR MAT	BOITIER + CABLE 150cm POUR DRIVER 90W		93,70 B
TR37505	NOIR MAT	CONVERTISSEUR 225W 48V AVEC BOITIER		489,30 B
CD144		CONVERTISSEUR 90W 48V		161,70 B
CD145		CONVERTISSEUR 180W 48V		188,50 B
CD146		CONVERTISSEUR 400W 48V		406,90 B
<b>CONVERTISSEURS DIMMABLES</b>				
CD165		CONVERTISSEUR 65W 48V DALI-PUSH		380,10 B
CD166		CONVERTISSEUR 135W 48V DALI-PUSH		461,60 B
<b>ACCESSOIRE DE SUSPENSION</b>				
TR25105	NOIR MAT	FILIN DE SUSPENSION 150cm		16,50 B
<b>MOULURES</b>				
TR25205	NOIR MAT	MOULURE DE FINITION 100cm		7,20 B
TR25305	NOIR MAT	MOULURE DE FINITION 200cm		11,30 B
TR25405	NOIR MAT	MOULURE DE FINITION 300cm		14,40 B
<b>EMBOUT</b>				
TR25505	NOIR MAT	EMBOUT DE FINITION		5,20 B

UTILISATION CONNECTEURS MÉCANIQUES

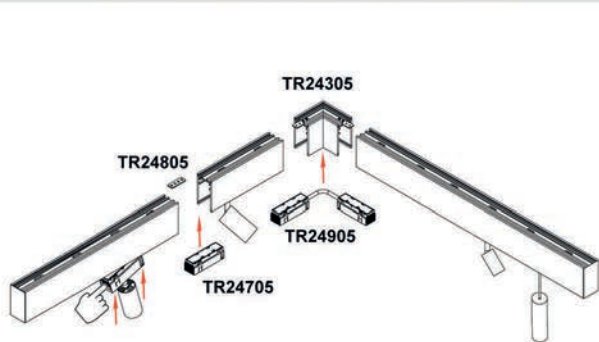

UTILISATION CONNECTEURS ÉLECTRIQUES POLARISÉS

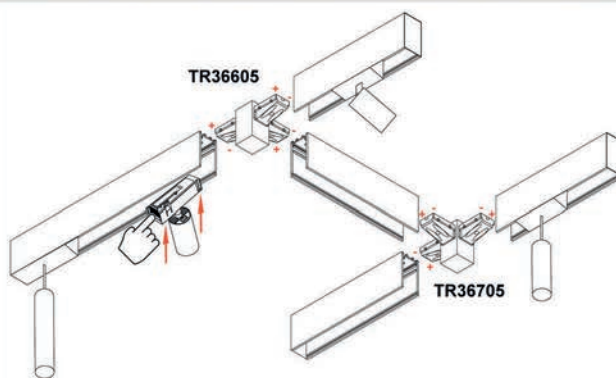







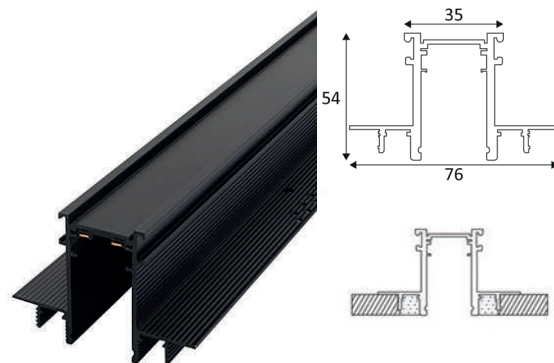



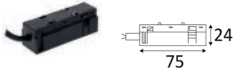

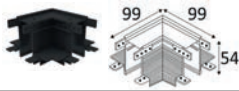
## TRACK 48VDC RECESSED

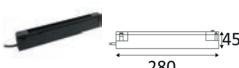

- Rail encastré 48Vdc.
- Enduit de finition à réaliser.
- Convertisseur à commander séparément.
- Le convertisseur peut être déporté ou inclus dans le rail en utilisant un boîtier prévu à cet effet (TR25005 + CD144 ou TR37505).
- Max. 20m et 400W en ligne continue.



TRACK 48VDC RECESSED			MATIÈRE	L (mm)	€
TR26005	NOIR MAT	MATT BLACK	ALUMINIUM	1000	90,60 B
TR26105	NOIR MAT	MATT BLACK	ALUMINIUM	2000	180,30 B
TR26205	NOIR MAT	MATT BLACK	ALUMINIUM	3000	269,90 B

ACCESSOIRES		DESCRIPTION	ALIMENTATION	€
<b>ALIMENTATION</b>				
TR24605	NOIR MAT	ALIMENTATION + CABLE 150cm		41,20 B
<b>CONNECTEURS</b>				
TR24805	METAL	CONNEXION MECANIQUE		7,20 B
TR24705	NOIR MAT	CONNEXION ELECTRIQUE		15,50 B
TR26305	NOIR MAT	CONNEXION L 90° PLAFOND AVEC TR24805		18,50 B
TR26405	NOIR MAT	CONNEXION L 90° MUR INT AVEC TR24805		18,50 B
TR26505	NOIR MAT	CONNEXION L 90° MUR EXT AVEC TR24805		18,50 B
TR24905	NOIR MAT	CONNEXION ELEC + CABLE POUR TR243/244/245 TR263/264/265		40,20 B
<b>CONVERTISSEURS</b>				
TR25005	NOIR MAT	BOITIER + CABLE 150cm POUR DRIVER 90W		93,70 B
TR37505	NOIR MAT	CONVERTISSEUR 225W 48V AVEC BOITIER		489,30 B
CD144		CONVERTISSEUR 90W 48V		161,70 B
CD145		CONVERTISSEUR 180W 48V		188,50 B
CD146		CONVERTISSEUR 400W 48V		406,90 B
<b>CONVERTISSEURS DIMMABLES</b>				
CD165		CONVERTISSEUR 65W 48V DALI-PUSH		380,10 B



ACCESSOIRES	DESCRIPTION	€
<b>CONVERTISSEURS DIMMABLES</b>		
CD166	CONVERTISSEUR 135W 48V DALI-PUSH	461,60 B
<b>EMBOUT</b>		
TR25505	NOIR MAT EMBOUT DE FINITION	5,20 B

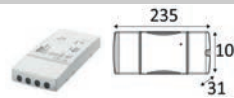

**UTILISATION CONNECTEURS MÉCANIQUES**

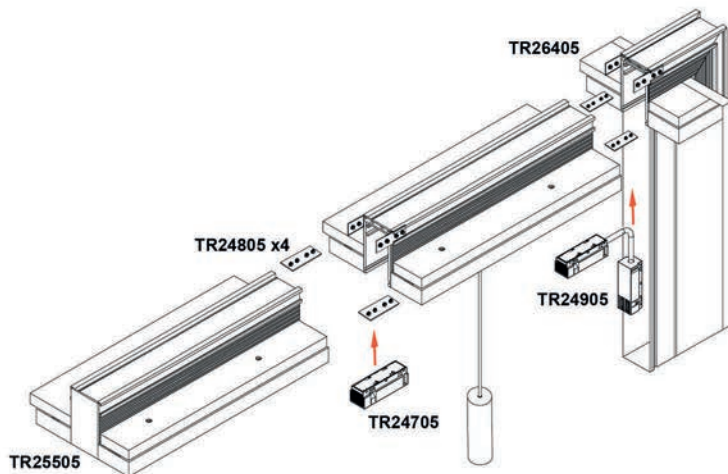

**INSTALLATION AVANT LE MONTAGE DU FAUX PLAFOND      INSTALLATION FAUX PLAFOND EXISTANT**

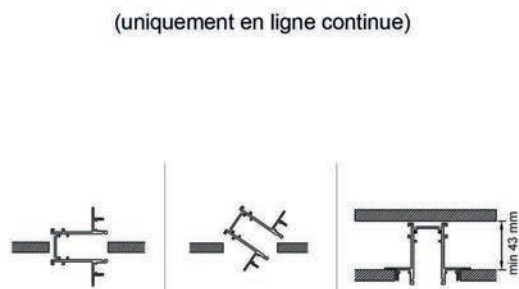
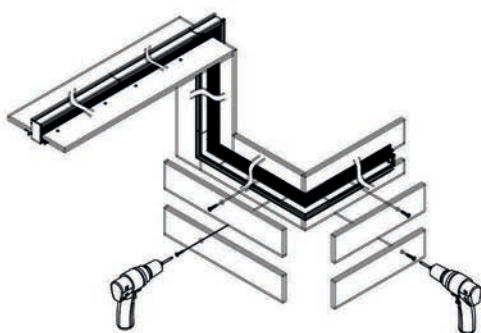

### KARO 1

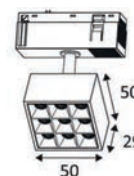
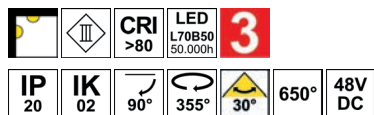

- Luminaire pour éclairage d'accentuation pour rail 48V.
- Non dimmable.

KARO 1	MATIÈRE	LED	T°	LED Lumen	System Lumen	€
TR360WW05	■ NOIR MAT ALUMINIUM	7W	3000K	1150 Lm	523 Lm	84,50 B
TR360NW05	■ NOIR MAT ALUMINIUM	7W	4000K	1250 Lm	530 Lm	84,50 B

### KARO 2

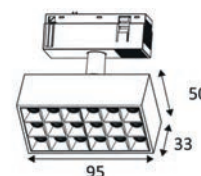
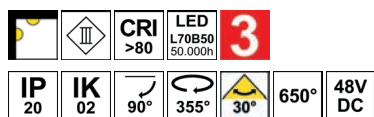

- Luminaire pour éclairage d'accentuation pour rail 48V.
- Non dimmable.

KARO 2	MATIÈRE	LED	T°	LED Lumen	System Lumen	€
TR361WW05	■ NOIR MAT ALUMINIUM	15W	3000K	1750 Lm	1138 Lm	114,30 B
TR361NW05	■ NOIR MAT ALUMINIUM	15W	4000K	1850 Lm	1146 Lm	114,30 B

### KARO 3

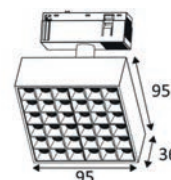
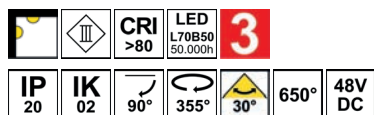

- Luminaire pour éclairage d'accentuation pour rail 48V.
- Non dimmable.

KARO 3	MATIÈRE	LED	T°	LED Lumen	System Lumen	€
TR362WW05	■ NOIR MAT ALUMINIUM	25W	3000K	3000 Lm	2114 Lm	141,10 B
TR362NW05	■ NOIR MAT ALUMINIUM	25W	4000K	3100 Lm	2221 Lm	141,10 B



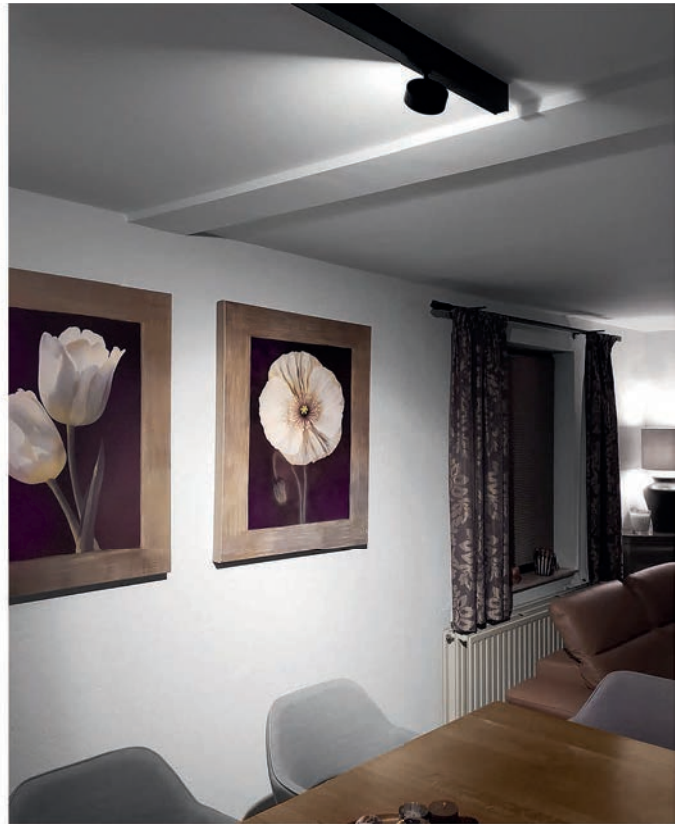



## LOOP 1

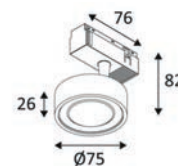
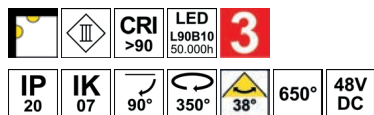

- Projecteur pour éclairage d'accentuation pour rail 48V.
- Non dimmable.

LOOP 1	MATIÈRE	LED	T°	LED Lumen	System Lumen	€	
TR391WW05	NOIR MAT	ALUMINIUM	10W	3000K	630 Lm	555 Lm	114,30 B

## LOOP 2

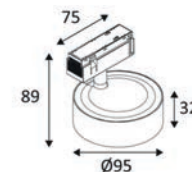
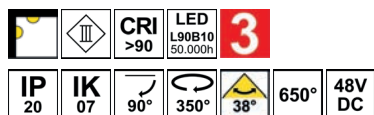

- Projecteur pour éclairage d'accentuation pour rail 48V.
- Non dimmable.

LOOP 2	MATIÈRE	LED	T°	LED Lumen	System Lumen	€	
TR392WW05	NOIR MAT	ALUMINIUM	13W	3000K	1430 Lm	1220 Lm	120,50 B
TR392WW13	MATT BLACK - BRASS MAT	ALUMINIUM	13W	3000K	1430 Lm	1220 Lm	123,60 B
TR392WW14	NOIR MAT - CUIVRE MAT	ALUMINIUM	13W	3000K	1430 Lm	1220 Lm	123,60 B



NOIR MAT

MATT BLACK - BRASS MAT

NOIR MAT - CUIVRE MAT







## PARO 1

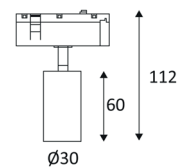
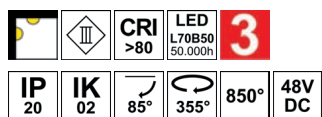

- Projecteur pour éclairage d'accentuation pour rail 48V.

PARO 1	MATIÈRE	LED	T°	LED Lumen	System Lumen	α	€		
<b>NON DIMMABLE</b>									
TR286SW05	NOIR MAT	ALUMINIUM	8W	2700K	640 Lm	420 Lm	24°	59,70	B
TR286WW05	NOIR MAT	ALUMINIUM	8W	3000K	660 Lm	466 Lm	24°	62,80	B
TR286NW05	NOIR MAT	ALUMINIUM	8W	4000K	690 Lm	526 Lm	24°	62,80	B
TR285SW05	NOIR MAT	ALUMINIUM	8W	2700K	640 Lm	508 Lm	36°	80,30	B
TR285WW05	NOIR MAT	ALUMINIUM	8W	3000K	660 Lm	522 Lm	36°	80,30	B
TR285NW05	NOIR MAT	ALUMINIUM	8W	4000K	690 Lm	535 Lm	36°	80,30	B
TR284SW05	NOIR MAT	ALUMINIUM	8W	2700K	640 Lm	465 Lm	50°	59,70	B
TR284WW05	NOIR MAT	ALUMINIUM	8W	3000K	660 Lm	470 Lm	50°	62,80	B
TR284NW05	NOIR MAT	ALUMINIUM	8W	4000K	690 Lm	477 Lm	50°	62,80	B
<b>DIMMABLE DALI</b>									
TR286WW05DA	NOIR MAT	ALUMINIUM	8W	3000K	660 Lm	466 Lm	24°	199,80	B
TR286NW05DA	NOIR MAT	ALUMINIUM	8W	4000K	690 Lm	526 Lm	24°	199,80	B
TR285WW05DA	NOIR MAT	ALUMINIUM	8W	3000K	660 Lm	522 Lm	36°	197,80	B
TR285NW05DA	NOIR MAT	ALUMINIUM	8W	4000K	690 Lm	535 Lm	36°	197,80	B
TR284WW05DA	NOIR MAT	ALUMINIUM	8W	3000K	660 Lm	470 Lm	50°	199,80	B
TR284NW05DA	NOIR MAT	ALUMINIUM	8W	4000K	690 Lm	477 Lm	50°	199,80	B



## PARO 2

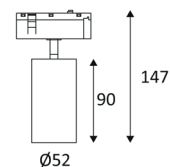
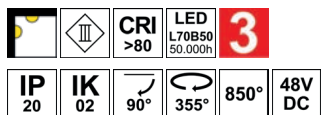

- Projecteur pour éclairage d'accentuation pour rail 48V.

PARO 2	MATIÈRE	LED	T°	LED Lumen	System Lumen	α	€
<b>NON DIMMABLE</b>							
TR289SW05	■ NOIR MAT	ALUMINIUM	14W	2700K	1250 Lm	943 Lm	15° 93,70 B
TR289WW05	■ NOIR MAT	ALUMINIUM	14W	3000K	1380 Lm	1014 Lm	15° 97,90 B
TR289NW05	■ NOIR MAT	ALUMINIUM	14W	4000K	1500 Lm	1090 Lm	15° 97,90 B
TR288SW05	■ NOIR MAT	ALUMINIUM	14W	2700K	1250 Lm	984 Lm	30° 124,60 B
TR288WW05	■ NOIR MAT	ALUMINIUM	14W	3000K	1380 Lm	1054 Lm	30° 124,60 B
TR288NW05	■ NOIR MAT	ALUMINIUM	14W	4000K	1500 Lm	1120 Lm	30° 124,60 B
TR287SW05	■ NOIR MAT	ALUMINIUM	14W	2700K	1250 Lm	974 Lm	50° 93,70 B
TR287WW05	■ NOIR MAT	ALUMINIUM	14W	3000K	1380 Lm	1151 Lm	50° 97,90 B
TR287NW05	■ NOIR MAT	ALUMINIUM	14W	4000K	1500 Lm	1198 Lm	50° 97,90 B
<b>DIMMABLE DALI</b>							
TR289WW05DA	■ NOIR MAT	ALUMINIUM	14W	3000K	1380 Lm	1014 Lm	15° 239,00 B
TR289NW05DA	■ NOIR MAT	ALUMINIUM	14W	4000K	1500 Lm	1090 Lm	15° 239,00 B
TR288WW05DA	■ NOIR MAT	ALUMINIUM	14W	3000K	1380 Lm	1054 Lm	30° 232,80 B
TR288NW05DA	■ NOIR MAT	ALUMINIUM	14W	4000K	1500 Lm	1120 Lm	30° 232,80 B
TR287WW05DA	■ NOIR MAT	ALUMINIUM	14W	3000K	1380 Lm	1151 Lm	50° 239,00 B
TR287NW05DA	■ NOIR MAT	ALUMINIUM	14W	4000K	1500 Lm	1198 Lm	50° 239,00 B

ACCESSOIRES	DESCRIPTION	€
TR29005	■ NOIR BAGUE	18,50 B
TR29105	■ NOIR WALL WASHER	28,80 B
TR29337	□ BAGUE OPALINE	7,20 B
TR29437	□ DIFFUSEUR OPALIN	3,10 B
TR29537	□ FILTRE LAME DE LUMIERE	3,10 B
TR29605	■ NOIR GRILLE NID D'ABEILLE	3,10 B





### PARO 3

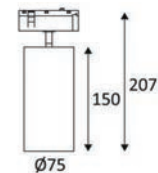
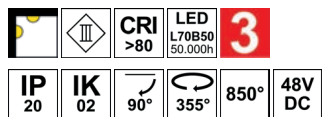

- Projecteur pour éclairage d'accentuation pour rail 48V.

PARO 3	MATIÈRE	LED	T°	LED Lumen	System Lumen	α	€
<b>NON DIMMABLE</b>							
TR300WW05	■ NOIR MAT	ALUMINIUM	35W	3000K	3820 Lm	2840 Lm	30° 215,30 B
TR300NW05	■ NOIR MAT	ALUMINIUM	35W	4000K	4200 Lm	3100 Lm	30° 215,30 B
TR299WW05	■ NOIR MAT	ALUMINIUM	35W	3000K	3820 Lm	2930 Lm	50° 171,00 B
TR299NW05	■ NOIR MAT	ALUMINIUM	35W	4000K	4200 Lm	3215 Lm	50° 171,00 B
<b>DIMMABLE DALI</b>							
TR300WW05DA	■ NOIR MAT	ALUMINIUM	28W	3000K	3400 Lm	2523 Lm	30° 304,90 B
TR300NW05DA	■ NOIR MAT	ALUMINIUM	28W	4000K	3700 Lm	2871 Lm	30° 304,90 B
TR299WW05DA	■ NOIR MAT	ALUMINIUM	28W	3000K	3400 Lm	2542 Lm	50° 318,30 B
TR299NW05DA	■ NOIR MAT	ALUMINIUM	28W	4000K	3700 Lm	2925 Lm	50° 318,30 B

ACCESSOIRES	DESCRIPTION	€
TR30105	■ NOIR BAGUE	33,00 B
TR30205	■ NOIR WALL WASHER	46,40 B
TR30337	□ BAGUE OPALINE	13,40 B
TR30437	□ DIFFUSEUR OPALIN	4,10 B
TR30537	□ FILTRE LAME DE LUMIERE	4,10 B
TR30605	■ NOIR GRILLE NID D'ABEILLE	6,20 B



### CADIX

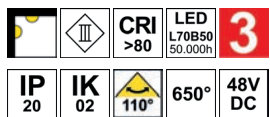

- Structure linéaire pour rail 48V.

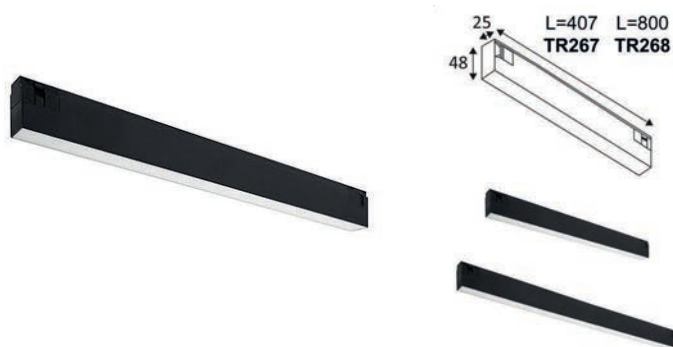

CADIX	MATIÈRE	LED	T°	LED Lumen	System Lumen	L (mm)	€
<b>NON DIMMABLE</b>							
TR267SW05	NOIR MAT	ALUMINIUM	11W 2700K	1280 Lm	777 Lm	407	125,70 B
TR267WW05	NOIR MAT	ALUMINIUM	11W 3000K	1325 Lm	783 Lm	407	125,70 B
TR267NW05	NOIR MAT	ALUMINIUM	11W 4000K	1440 Lm	992 Lm	407	125,70 B
TR268WW05	NOIR MAT	ALUMINIUM	18W 3000K	2305 Lm	1470 Lm	800	218,40 B
TR268NW05	NOIR MAT	ALUMINIUM	18W 4000K	2495 Lm	1485 Lm	800	218,40 B
<b>DIMMABLE DALI</b>							
TR267WW05DA	NOIR MAT	ALUMINIUM	11W 3000K	1325 Lm	783 Lm	407	233,80 B
TR267NW05DA	NOIR MAT	ALUMINIUM	11W 4000K	1440 Lm	992 Lm	407	233,80 B
TR268WW05DA	NOIR MAT	ALUMINIUM	18W 3000K	2305 Lm	1470 Lm	800	310,00 B
TR268NW05DA	NOIR MAT	ALUMINIUM	18W 4000K	2495 Lm	1485 Lm	800	310,00 B



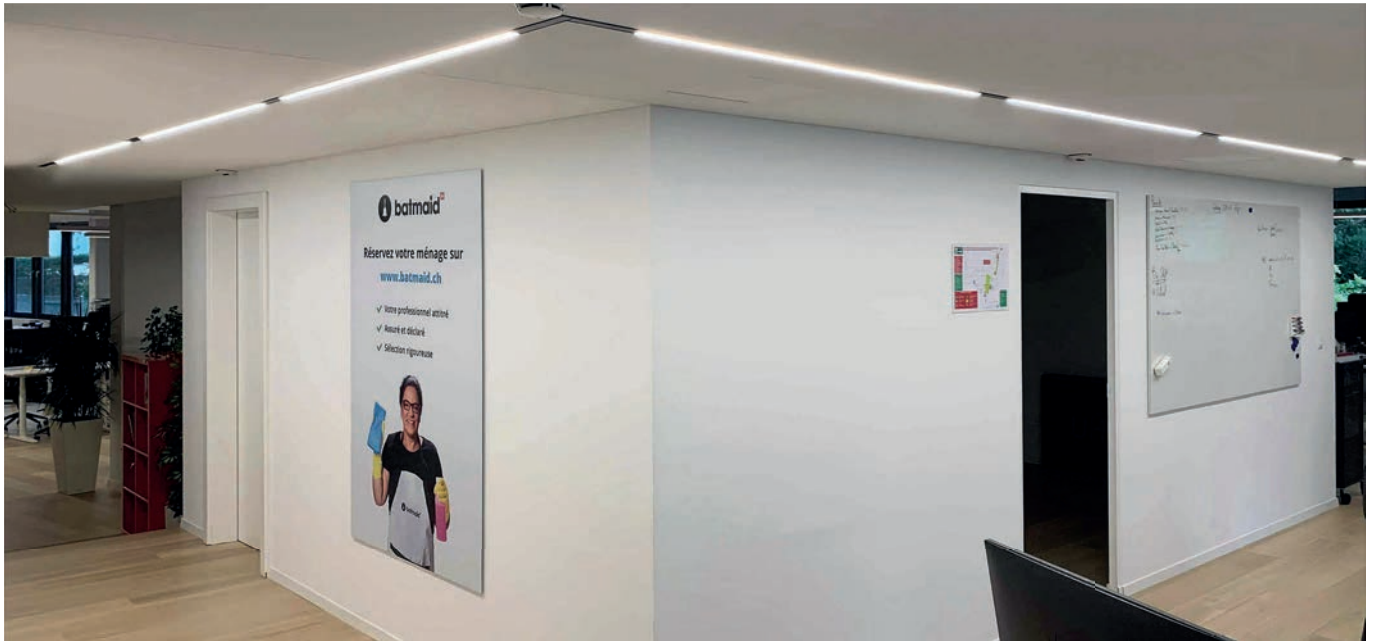

### ARRAS

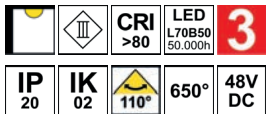

- Structure linéaire pour rail 48V.
- Non dimmable.



ARRAS	MATIÈRE	LED	T°	LED Lumen	System Lumen	L (mm)	€
TR376WW05	■ NOIR MAT ALUMINIUM	26W	3000K	3330 Lm	1249 Lm	1201	189,50 B
TR377WW05	■ NOIR MAT ALUMINIUM	35W	3000K	4330 Lm	1632 Lm	1599	253,40 B

### LEGA D

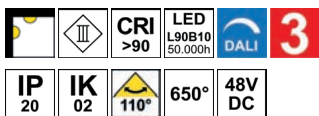

- Structure linéaire pour rail 48V.
- Dimmable DALI.



LEGA D	MATIÈRE	LED	T°	LED Lumen	System Lumen	€
TR364WW05DA	■ NOIR MAT ALUMINIUM	23W	3000K	2850 Lm	1737 Lm	330,60 B
TR364NW05DA	■ NOIR MAT ALUMINIUM	23W	4000K	2950 Lm	1814 Lm	330,60 B

## BERN

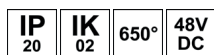

- Structure linéaire pour éclairage d'accentuation pour rail 48V.
- Réflecteur basse luminance.

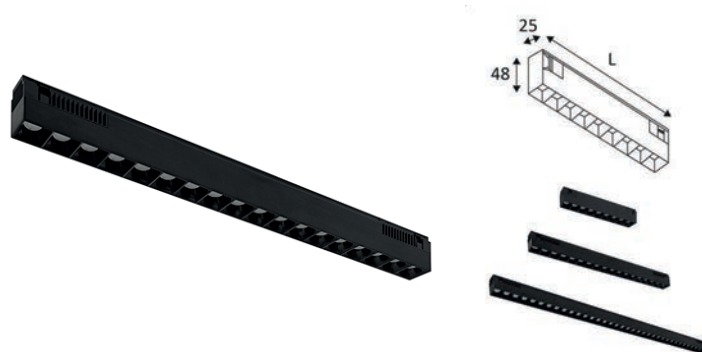

BERN		MATIÈRE	LED	T°	LED Lumen	System Lumen	α	L (mm)	€		
<b>NON DIMMABLE</b>											
TR281SW05	■	NOIR MAT	ALUMINIUM	12W	2700K	1000 Lm	802 Lm	12°	205	155,50	B
TR281WW05	■	NOIR MAT	ALUMINIUM	12W	3000K	1030 Lm	832 Lm	12°	205	163,80	B
TR281NW05	■	NOIR MAT	ALUMINIUM	12W	4000K	1270 Lm	878 Lm	12°	205	163,80	B
TR280SW05	■	NOIR MAT	ALUMINIUM	12W	2700K	1000 Lm	831 Lm	24°	205	155,50	B
TR280WW05	■	NOIR MAT	ALUMINIUM	12W	3000K	1030 Lm	865 Lm	24°	205	163,80	B
TR280NW05	■	NOIR MAT	ALUMINIUM	12W	4000K	1270 Lm	941 Lm	24°	205	163,80	B
TR279SW05	■	NOIR MAT	ALUMINIUM	12W	2700K	1000 Lm	816 Lm	36°	205	163,80	B
TR279WW05	■	NOIR MAT	ALUMINIUM	12W	3000K	1030 Lm	849 Lm	36°	205	163,80	B
TR279NW05	■	NOIR MAT	ALUMINIUM	12W	4000K	1270 Lm	939 Lm	36°	205	163,80	B
TR378WW05	■	NOIR MAT	ALUMINIUM	21W	3000K	1850 Lm	1475 Lm	12°	407	296,60	B
TR379WW05	■	NOIR MAT	ALUMINIUM	21W	3000K	1850 Lm	1512 Lm	24°	407	296,60	B
TR380WW05	■	NOIR MAT	ALUMINIUM	21W	3000K	1850 Lm	1510 Lm	36°	407	296,60	B
TR381WW05	■	NOIR MAT	ALUMINIUM	39W	3000K	3710 Lm	3006 Lm	12°	812	516,00	B
TR382WW05	■	NOIR MAT	ALUMINIUM	39W	3000K	3710 Lm	3021 Lm	24°	812	516,00	B
TR383WW05	■	NOIR MAT	ALUMINIUM	39W	3000K	3710 Lm	3041 Lm	36°	812	516,00	B
<b>DIMMABLE DALI</b>											
TR281WW05DA	■	NOIR MAT	ALUMINIUM	12W	3000K	1030 Lm	832 Lm	12°	205	264,70	B
TR281NW05DA	■	NOIR MAT	ALUMINIUM	12W	4000K	1270 Lm	878 Lm	12°	205	264,70	B
TR280WW05DA	■	NOIR MAT	ALUMINIUM	12W	3000K	1030 Lm	865 Lm	24°	205	264,70	B
TR280NW05DA	■	NOIR MAT	ALUMINIUM	12W	4000K	1270 Lm	941 Lm	24°	205	264,70	B
TR279WW05DA	■	NOIR MAT	ALUMINIUM	12W	3000K	1030 Lm	849 Lm	36°	205	264,70	B
TR279NW05DA	■	NOIR MAT	ALUMINIUM	12W	4000K	1270 Lm	939 Lm	36°	205	264,70	B
TR378WW05DA	■	NOIR MAT	ALUMINIUM	21W	3000K	1850 Lm	1475 Lm	12°	407	442,90	B
TR379WW05DA	■	NOIR MAT	ALUMINIUM	21W	3000K	1850 Lm	1512 Lm	24°	407	442,90	B
TR380WW05DA	■	NOIR MAT	ALUMINIUM	21W	3000K	1850 Lm	1510 Lm	36°	407	409,90	B
TR381WW05DA	■	NOIR MAT	ALUMINIUM	26W	3000K	2200 Lm	1745 Lm	12°	812	662,30	B
TR382WW05DA	■	NOIR MAT	ALUMINIUM	26W	3000K	2200 Lm	1803 Lm	24°	812	662,30	B
TR383WW05DA	■	NOIR MAT	ALUMINIUM	26W	3000K	2200 Lm	1772 Lm	36°	812	629,30	B





## VIGO

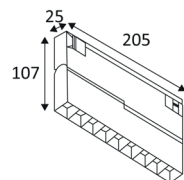
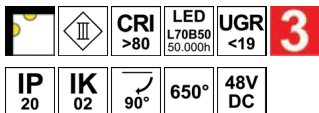

- Luminaire pour éclairage d'accentuation pour rail 48V.
- Réflecteur basse luminance.

VIGO	MATIÈRE	LED	T°	LED Lumen	System Lumen	α	€
<b>NON DIMMABLE</b>							
TR272WW05	NOIR MAT	ALUMINIUM	12W 3000K	1030 Lm	888 Lm	12°	237,90 B
TR272NW05	NOIR MAT	ALUMINIUM	12W 4000K	1270 Lm	1015 Lm	12°	237,90 B
TR271WW05	NOIR MAT	ALUMINIUM	12W 3000K	1030 Lm	915 Lm	24°	237,90 B
TR271NW05	NOIR MAT	ALUMINIUM	12W 4000K	1270 Lm	995 Lm	24°	237,90 B
TR270WW05	NOIR MAT	ALUMINIUM	12W 3000K	1030 Lm	939 Lm	36°	237,90 B
TR270NW05	NOIR MAT	ALUMINIUM	12W 4000K	1270 Lm	984 Lm	36°	237,90 B
<b>DIMMABLE DALI</b>							
TR272WW05DA	NOIR MAT	ALUMINIUM	12W 3000K	1030 Lm	888 Lm	12°	318,30 B
TR272NW05DA	NOIR MAT	ALUMINIUM	12W 4000K	1270 Lm	1015 Lm	12°	318,30 B
TR271WW05DA	NOIR MAT	ALUMINIUM	12W 3000K	1030 Lm	915 Lm	24°	318,30 B
TR271NW05DA	NOIR MAT	ALUMINIUM	12W 4000K	1270 Lm	995 Lm	24°	318,30 B
TR270WW05DA	NOIR MAT	ALUMINIUM	12W 3000K	1030 Lm	939 Lm	36°	318,30 B
TR270NW05DA	NOIR MAT	ALUMINIUM	12W 4000K	1270 Lm	984 Lm	36°	318,30 B

## ONEX

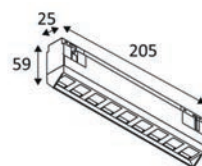
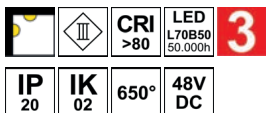

- Luminaire pour éclairage d'accentuation pour rail 48V.
- Wall washer.

ONEX	MATIÈRE	LED	T°	LED Lumen	System Lumen	€
<b>NON DIMMABLE</b>						
TR283WW05	NOIR MAT	ALUMINIUM	12W 3000K	1030 Lm	526 Lm	188,50 B
TR283NW05	NOIR MAT	ALUMINIUM	12W 4000K	1270 Lm	594 Lm	188,50 B
<b>DIMMABLE DALI</b>						
TR283WW05DA	NOIR MAT	ALUMINIUM	12W 3000K	1030 Lm	526 Lm	285,30 B
TR283NW05DA	NOIR MAT	ALUMINIUM	12W 4000K	1270 Lm	594 Lm	285,30 B





## IRO 1

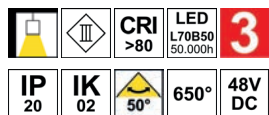

- Suspension pour rail 48V.
- Livrée avec une longueur de câble réglable de 1.50m.



IRO 1	MATIÈRE	LED	T°	LED Lumen	System Lumen	€
<b>NON DIMMABLE</b>						
TR311SW05	■ NOIR MAT	ALUMINIUM	8W	2700K	640 Lm	465 Lm 95,80 B
TR311WW05	■ NOIR MAT	ALUMINIUM	8W	3000K	660 Lm	470 Lm 95,80 B
TR311NW05	■ NOIR MAT	ALUMINIUM	8W	4000K	690 Lm	487 Lm 95,80 B
<b>DIMMABLE DALI</b>						
TR311WW05DA	■ NOIR MAT	ALUMINIUM	8W	3000K	660 Lm	470 Lm 208,10 B
TR311NW05DA	■ NOIR MAT	ALUMINIUM	8W	4000K	690 Lm	487 Lm 208,10 B

## IRO 2

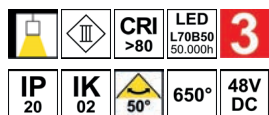

- Suspension pour rail 48V.
- Livrée avec une longueur de câble réglable de 1.50m.



IRO 2	MATIÈRE	LED	T°	LED Lumen	System Lumen	€
<b>NON DIMMABLE</b>						
TR312SW05	■ NOIR MAT	ALUMINIUM	19W	2700K	1850 Lm	1200 Lm 134,90 B
TR312WW05	■ NOIR MAT	ALUMINIUM	19W	3000K	2050 Lm	1215 Lm 134,90 B
TR312NW05	■ NOIR MAT	ALUMINIUM	19W	4000K	2270 Lm	1651 Lm 134,90 B
<b>DIMMABLE DALI</b>						
TR312WW05DA	■ NOIR MAT	ALUMINIUM	19W	3000K	2050 Lm	1215 Lm 241,00 B
TR312NW05DA	■ NOIR MAT	ALUMINIUM	19W	4000K	2270 Lm	1651 Lm 241,00 B



# INDIGO

LIGHTING



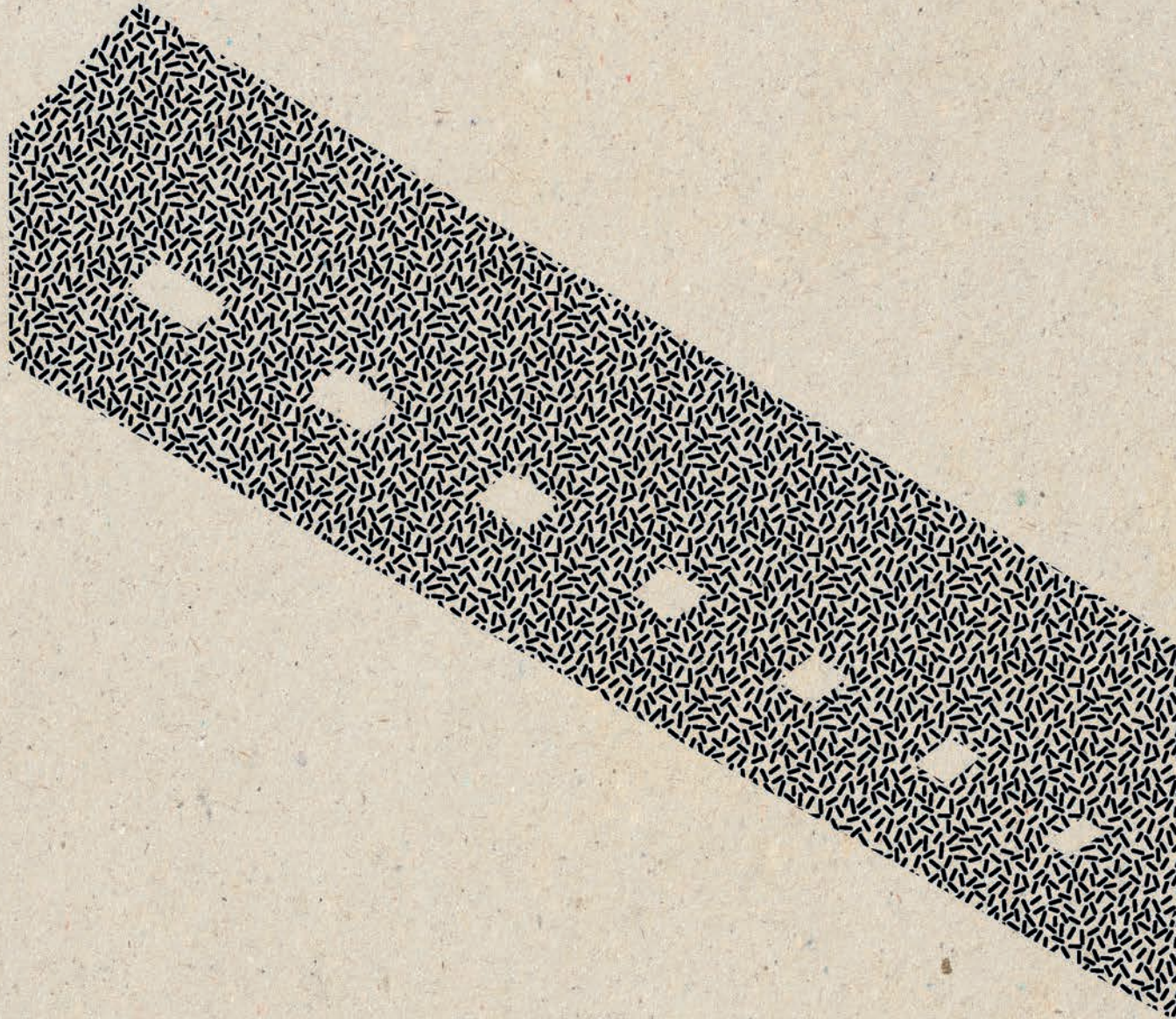

## **LIGNES CONTINUES**





### LINEAR C : MISE EN LIGNE

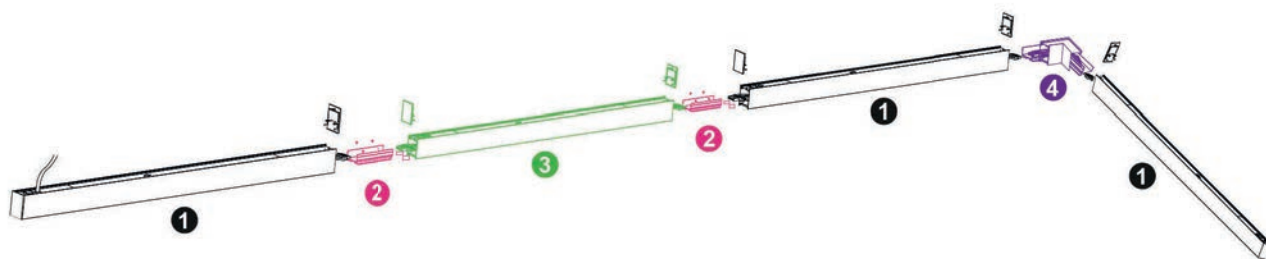

❶ CL100 / CL108 = **LINEAR C**

ACCESSOIRES À COMMANDER SÉPARÉMENT :

- ❷ CL102 = CONNEXION MÉCANIQUE
- ❸ CL104 = MODULE ÉLECTRIFIÉ 120cm
- ❹ CL105 = CONNEXION L

### LINEAR P : MISE EN LIGNE

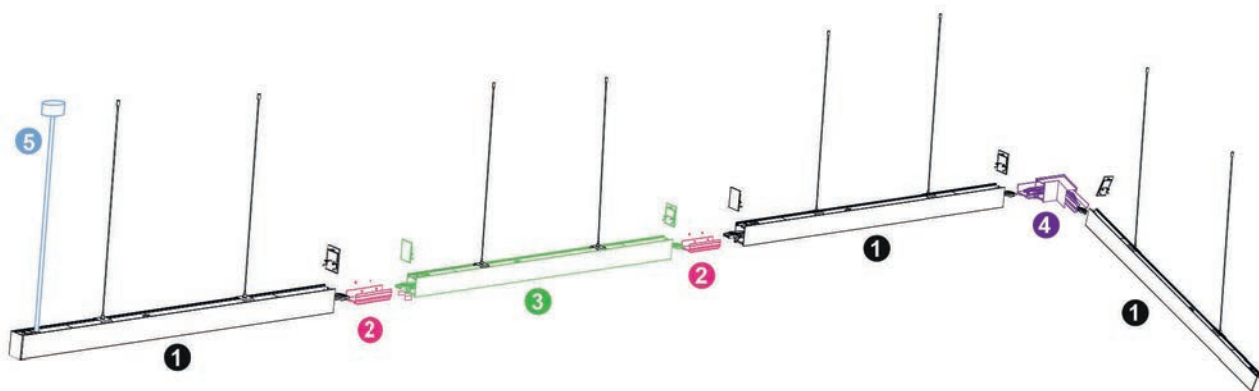

❶ CL101 / CL109 = **LINEAR P**

ACCESSOIRES À COMMANDER SÉPARÉMENT :

- ❷ CL102 = CONNEXION MÉCANIQUE
- ❸ CL110 = MODULE ÉLECTRIFIÉ 120cm
- ❹ CL105 = CONNEXION L
- ❺ CL103 = CÂBLE D'ALIMENTATION 200cm + BASE

## LINEAR 1 C

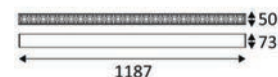
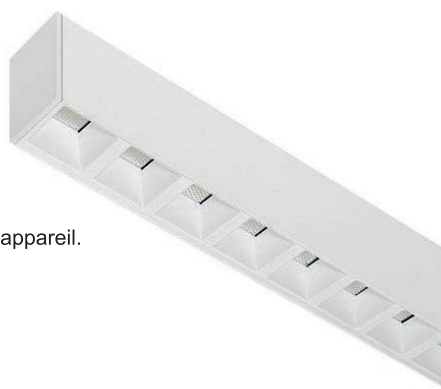
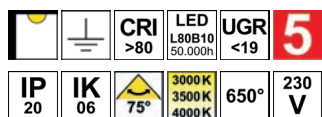

- Plafonnier linéaire.
- Réflecteur basse luminance.
- 3000K, 3500K ou 4000K au choix via un interrupteur à l'arrière du luminaire.
- Convertisseur non dimmable ou dimmable DALI-push intégré dans l'appareil.
- Possibilité de mise en ligne jusqu'à maximum 25 luminaires.
- Connexion mécanique linéaire à commander séparément. Connexions électriques rapides incluses dans le luminaire.

LINEAR 1 C	MATIÈRE	LED	T°	LED Lumen	System Lumen	€
<b>NON DIMMABLE</b>						
CL10005	NOIR MAT	ALUMINIUM	38W	3000-3500-4000K	6625 Lm (4000K)	2890 Lm (4000K) 199,00 B
CL10017	NOIR MAT - ARGENT	ALUMINIUM	38W	3000-3500-4000K	6625 Lm (4000K)	4580 Lm (4000K) 199,00 B
CL10030	BLANC MAT	ALUMINIUM	38W	3000-3500-4000K	6625 Lm (4000K)	4770 Lm (4000K) 199,00 B
CL10053	BLANC MAT - ARGENT	ALUMINIUM	38W	3000-3500-4000K	6625 Lm (4000K)	4580 Lm (4000K) 199,00 B
<b>DIMMABLE DALI</b>						
CL10005DA	NOIR MAT	ALUMINIUM	38W	3000-3500-4000K	6625 Lm (4000K)	2890 Lm (4000K) 258,00 B
CL10017DA	NOIR MAT - ARGENT	ALUMINIUM	38W	3000-3500-4000K	6625 Lm (4000K)	4580 Lm (4000K) 258,00 B
CL10030DA	BLANC MAT	ALUMINIUM	38W	3000-3500-4000K	6625 Lm (4000K)	4770 Lm (4000K) 258,00 B
CL10053DA	BLANC MAT - ARGENT	ALUMINIUM	38W	3000-3500-4000K	6625 Lm (4000K)	4580 Lm (4000K) 258,00 B



ACCESSOIRES	MATIÈRE	€	
CL10220	ALUMINIUM	CONNEXION MECANIQUE 47,5 120 8,20 B	
CL10405	NOIR MAT	ALUMINIUM	MODULE ELECTRIFIE 120cm 1200 92,00 B
CL10430	BLANC MAT	ALUMINIUM	MODULE ELECTRIFIE 120cm 92,00 B
CL10505	NOIR MAT	ALUMINIUM	CONNEXION L 169 99 58,50 B
CL10530	BLANC MAT	ALUMINIUM	CONNEXION L 58,50 B
CL10605	NOIR MAT	ALUMINIUM	CONNEXION T 169 99 288 148 78,00 B
CL10630	BLANC MAT	ALUMINIUM	CONNEXION T 78,00 B
CL10705	NOIR MAT	ALUMINIUM	CONNEXION X 288 148 97,90 B
CL10730	BLANC MAT	ALUMINIUM	CONNEXION X 97,90 B



NOIR MAT

NOIR MAT - ARGENT

BLANC MAT

BLANC MAT - ARGENT







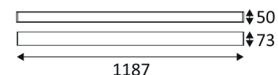
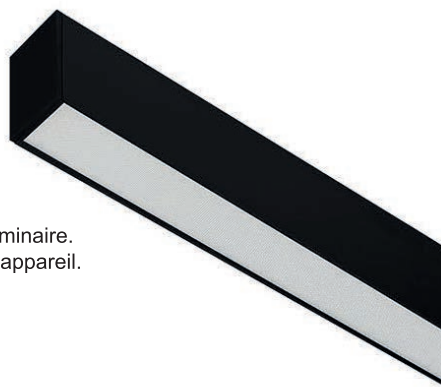
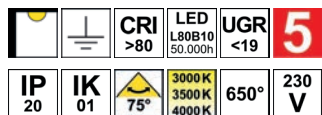





## LINEAR 2 C

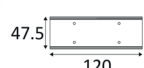

- Plafonnier linéaire.
- Diffuseur PC à structure prismatique.
- Multi-puissance : 21 ou 32W au choix via un interrupteur à l'arrière du luminaire.
- 3000K, 3500K ou 4000K au choix via un interrupteur à l'arrière du luminaire.
- Convertisseur non dimmable ou dimmable DALI-push intégré dans l'appareil.
- Possibilité de mise en ligne jusqu'à maximum 25 luminaires.
- Connexion mécanique linéaire à commander séparément.
- Connexions électriques rapides incluses dans le luminaire.

LINEAR 2 C	MATIÈRE	LED	T°	LED Lumen	System Lumen	€	
<b>NON DIMMABLE</b>							
<b>CL10805</b>	<b>NEW</b> NOIR MAT	ALUMINIUM	21W 32W	3000-3500-4000K	3350 Lm (4000K) 5100 Lm (4000K)	2045 Lm (4000K) 2990 Lm (4000K)	<b>199,00</b> B
<b>CL10830</b>	<b>NEW</b> BLANC MAT	ALUMINIUM	21W 32W	3000-3500-4000K	3350 Lm (4000K) 5100 Lm (4000K)	2560 Lm (4000K) 3740 Lm (4000K)	<b>199,00</b> B
<b>DIMMABLE DALI</b>							
<b>CL10805DA</b>	<b>NEW</b> NOIR MAT	ALUMINIUM	21W 32W	3000-3500-4000K	3350 Lm (4000K) 5100 Lm (4000K)	2045 Lm (4000K) 2990 Lm (4000K)	<b>255,00</b> B
<b>CL10830DA</b>	<b>NEW</b> BLANC MAT	ALUMINIUM	21W 32W	3000-3500-4000K	3350 Lm (4000K) 5100 Lm (4000K)	2560 Lm (4000K) 3740 Lm (4000K)	<b>255,00</b> B



ACCESSOIRES	MATIÈRE	€	
<b>CL10220</b>	ALUMINIUM	CONNEXION MECANIQUE	 47,5  <b>8,20</b> B
<b>CL10405</b>	<b>NEW</b> NOIR MAT	ALUMINIUM	MODULE ELECTRIFIE 120cm  1200 <b>92,00</b> B
<b>CL10430</b>	<b>NEW</b> BLANC MAT	ALUMINIUM	MODULE ELECTRIFIE 120cm  <b>92,00</b> B
<b>CL10505</b>	<b>NEW</b> NOIR MAT	ALUMINIUM	CONNEXION L  169 99 <b>58,50</b> B
<b>CL10530</b>	<b>NEW</b> BLANC MAT	ALUMINIUM	CONNEXION L  <b>58,50</b> B
<b>CL10605</b>	<b>NEW</b> NOIR MAT	ALUMINIUM	CONNEXION T  169 99 288 148 <b>78,00</b> B
<b>CL10630</b>	<b>NEW</b> BLANC MAT	ALUMINIUM	CONNEXION T  <b>78,00</b> B
<b>CL10705</b>	<b>NEW</b> NOIR MAT	ALUMINIUM	CONNEXION X  288 148 <b>97,90</b> B
<b>CL10730</b>	<b>NEW</b> BLANC MAT	ALUMINIUM	CONNEXION X  <b>97,90</b> B



NOIR MAT

BLANC MAT



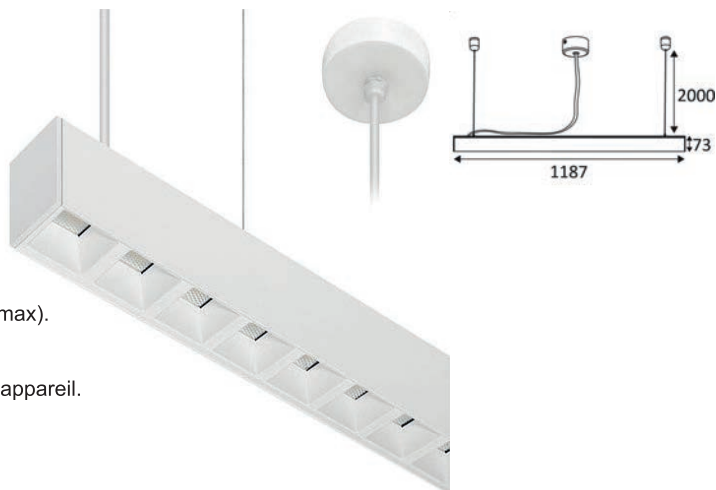
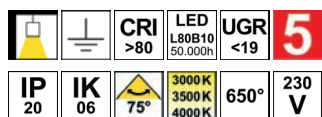





## LINEAR 1 P

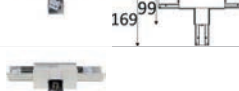

- Suspension linéaire.
- Réflecteur basse luminance.
- 3000K, 3500K ou 4000K au choix via un interrupteur à l'arrière du luminaire.
- Livrée avec câbles de suspension blancs ou noirs (réglables 2.00m max).
- Base ronde et câble d'alimentation blancs ou noirs (L: 2,00m) à commander séparément.
- Convertisseur non dimmable ou dimmable DALI-push intégré dans l'appareil.
- Possibilité de mise en ligne jusqu'à maximum 25 luminaires.
- Connexion mécanique linéaire à commander séparément. Connexions électriques rapides incluses dans le luminaire.

LINEAR 1 P	MATIÈRE	LED	T°	LED Lumen	System Lumen	€
<b>NON DIMMABLE</b>						
CL10105	NOIR MAT	ALUMINIUM	38W	3000-3500-4000K	6625 Lm (4000K)	2890 Lm (4000K) <b>205,00</b> B
CL10117	NOIR MAT - ARGENT	ALUMINIUM	38W	3000-3500-4000K	6625 Lm (4000K)	4580 Lm (4000K) <b>207,00</b> B
CL10130	BLANC MAT	ALUMINIUM	38W	3000-3500-4000K	6625 Lm (4000K)	4770 Lm (4000K) <b>205,00</b> B
CL10153	BLANC MAT - ARGENT	ALUMINIUM	38W	3000-3500-4000K	6625 Lm (4000K)	4580 Lm (4000K) <b>207,00</b> B
<b>DIMMABLE DALI</b>						
CL10105DA	NOIR MAT	ALUMINIUM	38W	3000-3500-4000K	6625 Lm (4000K)	2890 Lm (4000K) <b>265,00</b> B
CL10117DA	NOIR MAT - ARGENT	ALUMINIUM	38W	3000-3500-4000K	6625 Lm (4000K)	4580 Lm (4000K) <b>269,00</b> B
CL10130DA	BLANC MAT	ALUMINIUM	38W	3000-3500-4000K	6625 Lm (4000K)	4770 Lm (4000K) <b>265,00</b> B
CL10153DA	BLANC MAT - ARGENT	ALUMINIUM	38W	3000-3500-4000K	6625 Lm (4000K)	4580 Lm (4000K) <b>269,00</b> B

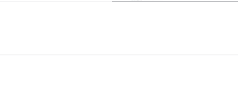

ACCESSOIRES	MATIÈRE	€		
CL10220	ALUMINIUM	CONNEXION MECANIQUE	 47,5 120 <b>8,20</b> B	
CL11005	NOIR MAT	ALUMINIUM	MODULE ELECTRIFIE 120cm	 2000 1200 <b>101,40</b> B
CL11030	BLANC MAT	ALUMINIUM	MODULE ELECTRIFIE 120cm	 <b>101,40</b> B
CL10505	NOIR MAT	ALUMINIUM	CONNEXION L	 99 169 99 <b>58,50</b> B
CL10530	BLANC MAT	ALUMINIUM	CONNEXION L	 <b>58,50</b> B
CL10605	NOIR MAT	ALUMINIUM	CONNEXION T	 288 148 169 99 <b>78,00</b> B
CL10630	BLANC MAT	ALUMINIUM	CONNEXION T	 <b>78,00</b> B
CL10705	NOIR MAT	ALUMINIUM	CONNEXION X	 288 148 <b>97,90</b> B
CL10730	BLANC MAT	ALUMINIUM	CONNEXION X	 <b>97,90</b> B
CL10305	NOIR		CABLE D'ALIMENTATION 200cm + BASE	 <b>14,00</b> B



CL10330	BLANC		CABLE D'ALIMENTATION 200cm + BASE	<b>14,00</b> B
---------	-------	--	-----------------------------------	----------------

CL10305DA	NOIR		CABLE D'ALIMENTATION DALI 200cm + BASE	<b>20,00</b> B
-----------	------	--	--	----------------



CL10330DA	BLANC		CABLE D'ALIMENTATION DALI 200cm + BASE	<b>20,00</b> B
-----------	-------	--	--	----------------





NEW



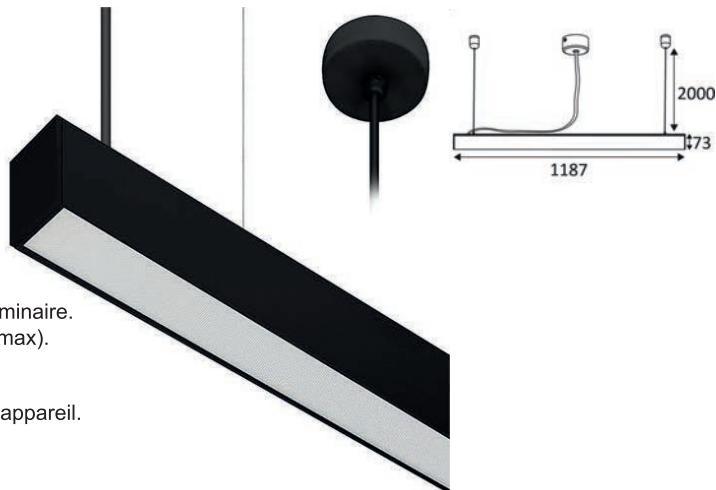
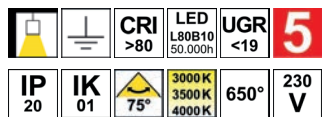









## LINEAR 2 P



- Suspension linéaire.
- Diffuseur PC à structure prismatique.
- Multi-puissance : 21 ou 32W au choix via un interrupteur à l'arrière du luminaire.
- 3000K, 3500K ou 4000K au choix via un interrupteur à l'arrière du luminaire.
- Livrée avec câbles de suspension blancs ou noirs (réglables 2.00m max).
- Base ronde et câble d'alimentation blancs ou noirs (L: 2,00m) à commander séparément.
- Convertisseur non dimmable ou dimmable DALI-push intégré dans l'appareil.
- Possibilité de mise en ligne jusqu'à maximum 25 luminaires.
- Connexion mécanique linéaire à commander séparément. Connexions électriques rapides incluses dans le luminaire.

LINEAR 2 P	MATIÈRE	LED	T°	LED Lumen	System Lumen	€	
<b>NON DIMMABLE</b>							
<b>CL10905</b>	<b>NEW</b> NOIR MAT	ALUMINIUM	21W 32W	3000-3500-4000K	3350 Lm (4000K) 5100 Lm (4000K)	2045 Lm (4000K) 2990 Lm (4000K)	<b>203,00</b> B
<b>CL10930</b>	<b>NEW</b> BLANC MAT	ALUMINIUM	21W 32W	3000-3500-4000K	3350 Lm (4000K) 5100 Lm (4000K)	2560 Lm (4000K) 3740 Lm (4000K)	<b>203,00</b> B
<b>DIMMABLE DALI</b>							
<b>CL10905DA</b>	<b>NEW</b> NOIR MAT	ALUMINIUM	21W 32W	3000-3500-4000K	3350 Lm (4000K) 5100 Lm (4000K)	2045 Lm (4000K) 2990 Lm (4000K)	<b>263,00</b> B
<b>CL10930DA</b>	<b>NEW</b> BLANC MAT	ALUMINIUM	21W 32W	3000-3500-4000K	3350 Lm (4000K) 5100 Lm (4000K)	2560 Lm (4000K) 3740 Lm (4000K)	<b>263,00</b> B



ACCESSOIRES	MATIÈRE	€			
<b>CL10220</b>	ALUMINIUM	CONNEXION MECANIQUE	 47,5 120	<b>8,20</b> B	
<b>CL11005</b>	<b>NEW</b> NOIR MAT	ALUMINIUM	MODULE ELECTRIFIE 120cm	 2000 1200	<b>101,40</b> B
<b>CL11030</b>	<b>NEW</b> BLANC MAT	ALUMINIUM	MODULE ELECTRIFIE 120cm	 2000 1200	<b>101,40</b> B
<b>CL10505</b>	<b>NEW</b> NOIR MAT	ALUMINIUM	CONNEXION L	 99 169	<b>58,50</b> B
<b>CL10530</b>	<b>NEW</b> BLANC MAT	ALUMINIUM	CONNEXION L	 99 169	<b>58,50</b> B
<b>CL10605</b>	<b>NEW</b> NOIR MAT	ALUMINIUM	CONNEXION T	 288 148 169	<b>78,00</b> B
<b>CL10630</b>	<b>NEW</b> BLANC MAT	ALUMINIUM	CONNEXION T	 288 148 169	<b>78,00</b> B
<b>CL10705</b>	<b>NEW</b> NOIR MAT	ALUMINIUM	CONNEXION X	 288 148	<b>97,90</b> B
<b>CL10730</b>	<b>NEW</b> BLANC MAT	ALUMINIUM	CONNEXION X	 288 148	<b>97,90</b> B
<b>CL10305</b>	NOIR	CABLE D'ALIMENTATION 200cm + BASE		<b>14,00</b> B	
<b>CL10330</b>	BLANC	CABLE D'ALIMENTATION 200cm + BASE		<b>14,00</b> B	
<b>CL10305DA</b>	NOIR	CABLE D'ALIMENTATION DALI 200cm + BASE		<b>20,00</b> B	
<b>CL10330DA</b>	BLANC	CABLE D'ALIMENTATION DALI 200cm + BASE		<b>20,00</b> B	

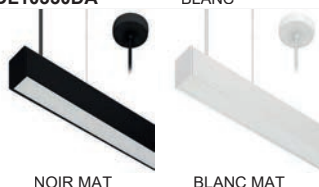

# INDIGO

LIGHTING

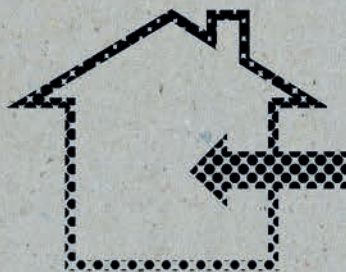

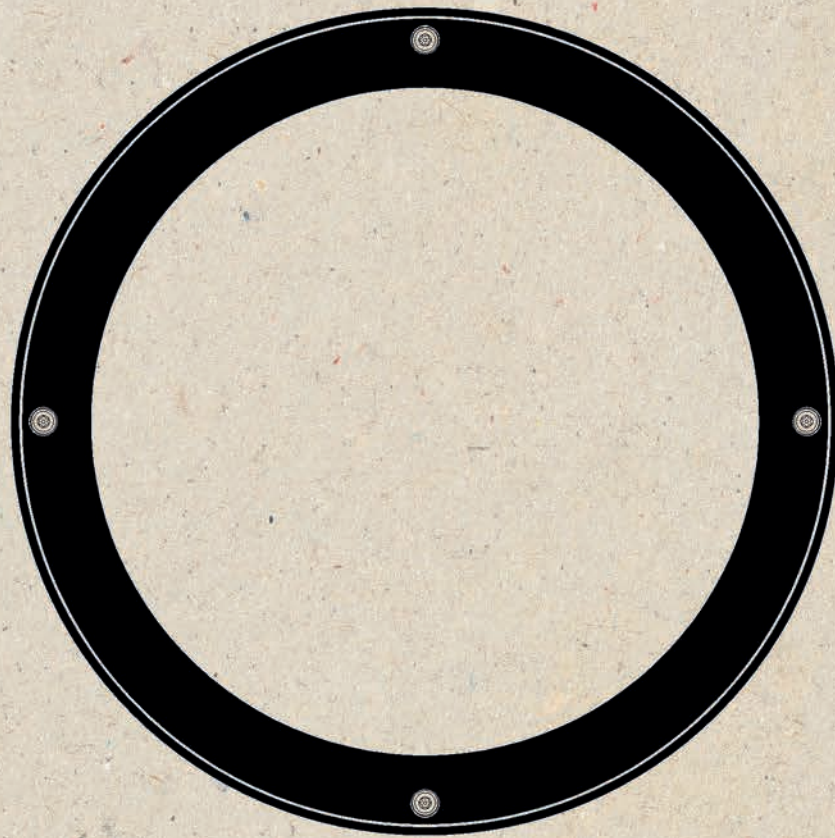

**HUBLOTS**

## MINI TIMY E27

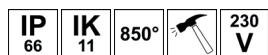

- Applique murale ou plafonnier pour éclairage intérieur et extérieur.
- Avec clé et vis anti-vandale.

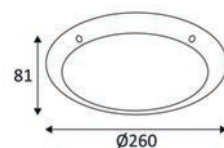

MINI TIMY E27	MATÉRIE	MATIÈRE	SOCKET	LAMP	Watt Max	€
OU44520	METAL	POLYCARBONATE	E27	CLA	23W	24,70 B
OU44530	NOIR	POLYCARBONATE	E27	CLA	23W	24,70 B
OU44531	BLANC	POLYCARBONATE	E27	CLA	23W	24,70 B



METAL



NOIR



BLANC

## MINI TIMY SENSOR E27

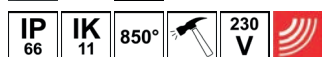

- Applique murale ou plafonnier pour éclairage intérieur et extérieur.
- Avec détecteur HF 360°, zone de détection réglable max. 10m de diamètre.
- Avec clé et vis anti-vandale.

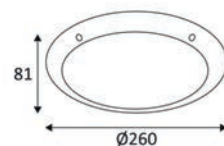

MINI TIMY SENSOR E27	MATÉRIE	MATIÈRE	SOCKET	LAMP	Watt Max	€
OU44620	METAL	POLYCARBONATE	E27	CLA	23W	46,40 B
OU44630	NOIR	POLYCARBONATE	E27	CLA	23W	46,40 B
OU44631	BLANC	POLYCARBONATE	E27	CLA	23W	46,40 B



METAL



NOIR



BLANC



## MINI TIMY

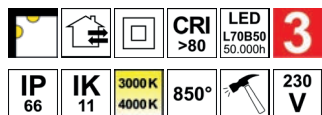

- Applique murale ou plafonnier pour éclairage intérieur et extérieur.
- 3000K ou 4000K au choix via un interrupteur dans le luminaire.
- Avec clé et vis anti-vandale.
- Convertisseur non dimmable intégré dans l'appareil.

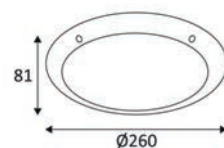

MINI TIMY		MATIÈRE	LED	T°	LED Lumen	System Lumen	€
OU395NW30	NOIR	POLYCARBONATE	12W	3000-4000K	1450 Lm (4000K)	1080 Lm (4000K)	44,30 B
OU395NW31	BLANC	POLYCARBONATE	12W	3000-4000K	1450 Lm (4000K)	1080 Lm (4000K)	44,30 B



NOIR



BLANC

## MINI TIMY SENSOR

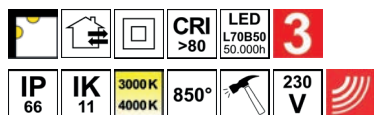

- Applique murale ou plafonnier pour éclairage intérieur et extérieur.
- 3000K ou 4000K au choix via un interrupteur dans le luminaire.
- Avec détecteur HF 360°, zone de détection réglable max. 10m de diamètre.
- Avec clé et vis anti-vandale.
- Convertisseur non dimmable intégré dans l'appareil.

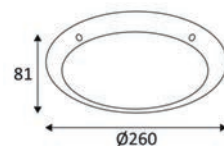

MINI TIMY SENSOR		MATIÈRE	LED	T°	LED Lumen	System Lumen	€
OU396NW30	NOIR	POLYCARBONATE	12W	3000-4000K	1450 Lm (4000K)	1080 Lm (4000K)	72,10 B
OU396NW31	BLANC	POLYCARBONATE	12W	3000-4000K	1450 Lm (4000K)	1080 Lm (4000K)	72,10 B



NOIR



BLANC

## TIMY

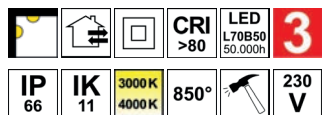

- Applique murale ou plafonnier pour éclairage intérieur et extérieur.
- 3000K ou 4000K au choix via un interrupteur dans le luminaire.
- Avec clé et vis anti-vandale.
- Convertisseur non dimmable intégré dans l'appareil.

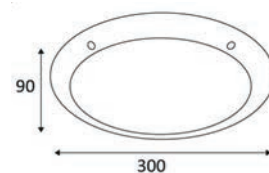

TIMY	MATÉRIEL	MATIÈRE	LED	T°	LED Lumen	System Lumen	€
TP1139WW20	MÉTAL	POLYCARBONATE	25W	3000-4000K	2350 Lm (4000K)	1935 Lm (4000K)	86,50 B
TP1139WW30	NOIR	POLYCARBONATE	25W	3000-4000K	2350 Lm (4000K)	1935 Lm (4000K)	86,50 B
TP1139WW31	BLANC	POLYCARBONATE	25W	3000-4000K	2350 Lm (4000K)	1935 Lm (4000K)	86,50 B



MÉTAL



NOIR



BLANC







## TIMY SENSOR

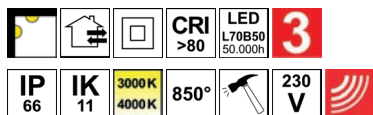

- Applique murale ou plafonnier pour éclairage intérieur et extérieur.
- 3000K ou 4000K au choix via un interrupteur dans le luminaire.
- Avec détecteur HF 360°, zone de détection réglable max. 10m de diamètre.
- Avec clé et vis anti-vandale.
- Convertisseur non dimmable intégré dans l'appareil.

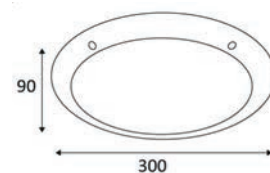

TIMY SENSOR		MATIÈRE	LED	T°	LED Lumen	System Lumen	€
OU13920	METAL	POLYCARBONATE	25W	3000-4000K	2350 Lm (4000K)	1935 Lm (4000K)	102,00 B
OU13930	NOIR	POLYCARBONATE	25W	3000-4000K	2350 Lm (4000K)	1935 Lm (4000K)	102,00 B
OU13931	BLANC	POLYCARBONATE	25W	3000-4000K	2350 Lm (4000K)	1935 Lm (4000K)	102,00 B



METAL



NOIR



BLANC



## LIDY

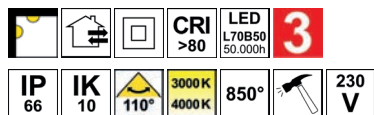

- Applique murale ou plafonnier pour éclairage intérieur et extérieur.
- 3000K ou 4000K au choix via un interrupteur dans le luminaire.
- Avec clé et vis anti-vandale.
- Convertisseur non dimmable intégré dans l'appareil.

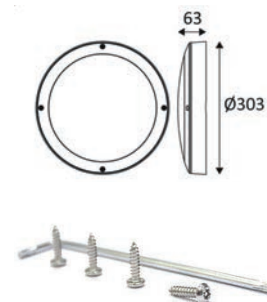

LIDY	MATIERE	LED	T°	LED Lumen	System Lumen	€	
<b>BU10105</b>	NOIR	POLYCARBONATE	24W	3000-4000K	4010 Lm (4000K)	2655 Lm (4000K)	<b>67,00</b> B
<b>BU10130</b>	BLANC	POLYCARBONATE	24W	3000-4000K	4010 Lm (4000K)	2655 Lm (4000K)	<b>67,00</b> B



NOIR



BLANC

## LIDY SENSOR

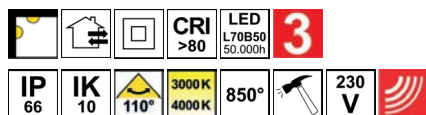

- Applique murale ou plafonnier pour éclairage intérieur et extérieur.
- 3000K ou 4000K au choix via un interrupteur dans le luminaire.
- Avec détecteur HF 360°, zone de détection réglable max. 10m de diamètre.
- Avec clé et vis anti-vandale.
- Convertisseur non dimmable intégré dans l'appareil.

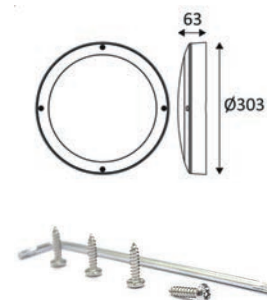

LIDY SENSOR	MATIERE	LED	T°	LED Lumen	System Lumen	€	
<b>BU10205</b>	NOIR	POLYCARBONATE	24W	3000-4000K	4010 Lm (4000K)	2655 Lm (4000K)	<b>93,70</b> B
<b>BU10230</b>	BLANC	POLYCARBONATE	24W	3000-4000K	4010 Lm (4000K)	2655 Lm (4000K)	<b>93,70</b> B



NOIR



BLANC



## LIDY A

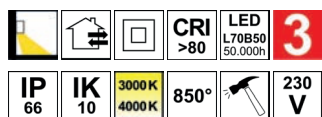

- Applique murale asymétrique pour éclairage intérieur et extérieur.
- 3000K ou 4000K au choix via un interrupteur dans le luminaire.
- Avec clé et vis anti-vandale.
- Convertisseur non dimmable intégré dans l'appareil.

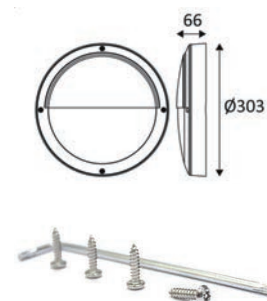

LIDY A	MATIERE	LED	T°	LED Lumen	System Lumen	€	
<b>BU10305</b>	NOIR	POLYCARBONATE	28W	3000-4000K	4810 Lm (4000K)	2930 Lm (4000K)	<b>73,10</b> B
<b>BU10330</b>	BLANC	POLYCARBONATE	28W	3000-4000K	4810 Lm (4000K)	2930 Lm (4000K)	<b>73,10</b> B



NOIR



BLANC

## LIDY A SENSOR

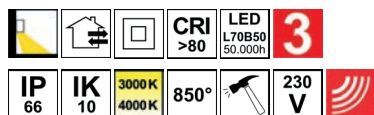

- Applique murale asymétrique pour éclairage intérieur et extérieur.
- 3000K ou 4000K au choix via un interrupteur dans le luminaire.
- Avec détecteur HF 360°, zone de détection réglable max. 10m de diamètre.
- Avec clé et vis anti-vandale.
- Convertisseur non dimmable intégré dans l'appareil.

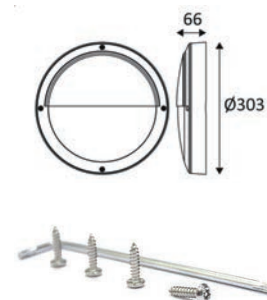

LIDY A SENSOR	MATIERE	LED	T°	LED Lumen	System Lumen	€	
<b>BU10405</b>	NOIR	POLYCARBONATE	28W	3000-4000K	4810 Lm (4000K)	2930 Lm (4000K)	<b>99,90</b> B
<b>BU10430</b>	BLANC	POLYCARBONATE	28W	3000-4000K	4810 Lm (4000K)	2930 Lm (4000K)	<b>99,90</b> B



NOIR



BLANC

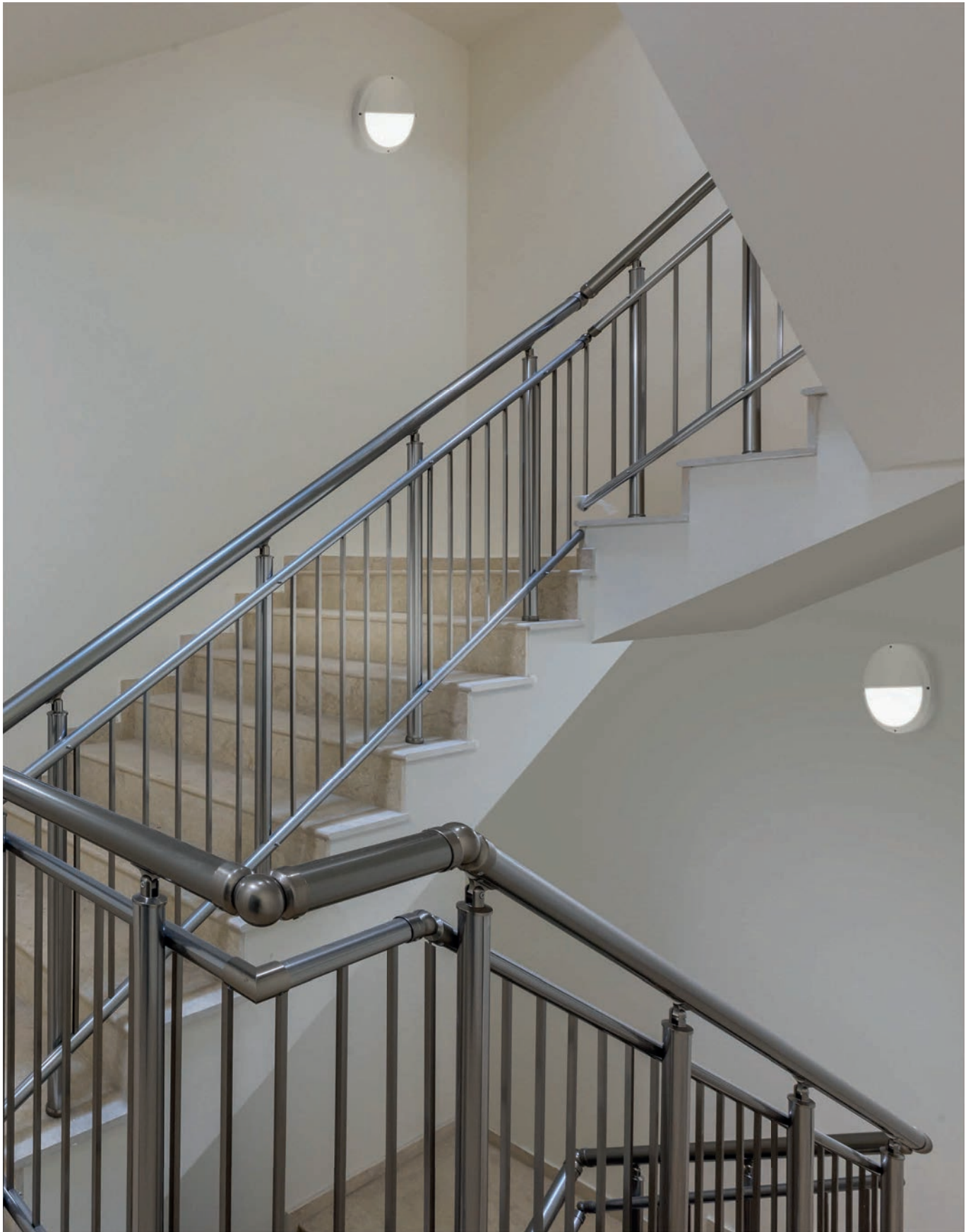

## WL94

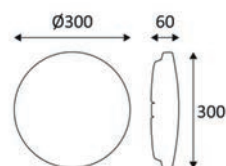
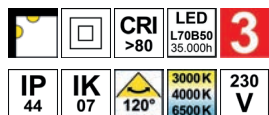

- Applique murale ou plafonnier pour éclairage intérieur.
- 3000K, 4000K ou 6500K au choix via un interrupteur à l'intérieur du luminaire.
- Convertisseur non dimmable intégré dans l'appareil.
- 4 versions disponibles : standard, avec détecteur HF, avec éclairage de secours ou avec détecteur HF & éclairage de secours.

WL94		MATIÈRE	LED	T°	LED Lumen	System Lumen	€
<b>STANDARD</b>							
WL9410SCS	NEW	BLANC	POLYCARBONATE	10W	3000-4000-6500K	1300 Lm (4000K) 1100 Lm (4000K)	46,70 A
WL9418SCS	NEW	BLANC	POLYCARBONATE	18W	3000-4000-6500K	2350 Lm (4000K) 2000 Lm (4000K)	52,60 A
<b>DETECTEUR HF</b>							
WL9410MCS	NEW	BLANC	POLYCARBONATE	10W	3000-4000-6500K	1300 Lm (4000K) 1100 Lm (4000K)	87,70 A
WL9418MCS	NEW	BLANC	POLYCARBONATE	18W	3000-4000-6500K	2350 Lm (4000K) 2000 Lm (4000K)	94,50 A
<b>ECLAIRAGE DE SECOURS</b>							
WL9410ECS	NEW	BLANC	POLYCARBONATE	10W	3000-4000-6500K	1300 Lm (4000K) 1100 Lm (4000K)	122,50 A
<b>DETECTEUR HF &amp; ECLAIRAGE DE SECOURS</b>							
WL9410CCS	NEW	BLANC	POLYCARBONATE	10W	3000-4000-6500K	1300 Lm (4000K) 1100 Lm (4000K)	160,50 A
WL9418CCS	NEW	BLANC	POLYCARBONATE	18W	3000-4000-6500K	2350 Lm (4000K) 2000 Lm (4000K)	166,70 A



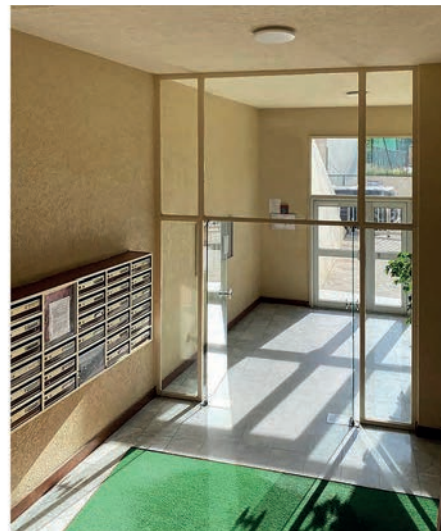

## ORKI

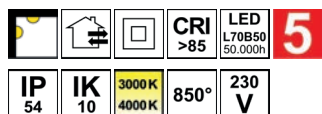

- Applique murale ou plafonnier pour éclairage intérieur et extérieur.
- 3000K ou 4000K au choix via un interrupteur à l'arrière du luminaire.
- Convertisseur non dimmable intégré dans l'appareil.

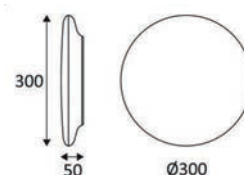

ORKI	MATIÈRE	LED	T°	LED Lumen	System Lumen	€	
OU41731	BLANC	POLYCARBONATE	18W	3000-4000K	2730 Lm (4000K)	1769 Lm (4000K)	81,40 B

## ORKI SENSOR

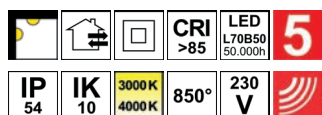

- Applique murale ou plafonnier pour éclairage intérieur et extérieur.
- 3000K ou 4000K au choix via un interrupteur à l'arrière du luminaire.
- Avec détecteur HF 360°, zone de détection réglable max. 10m de diamètre.
- Convertisseur non dimmable intégré dans l'appareil.

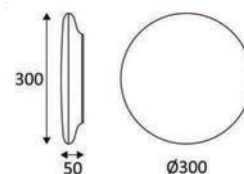

ORKI SENSOR	MATIÈRE	LED	T°	LED Lumen	System Lumen	€	
OU39731	BLANC	POLYCARBONATE	18W	3000-4000K	2730 Lm (4000K)	1769 Lm (4000K)	110,20 B

# INDIGO

LIGHTING







## **RÉGLETTES ÉTANCHES**

## POLARIS

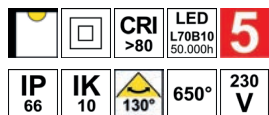

- Luminaire linéaire étanche.
- Diffuseur en polycarbonate.
- Avec câblage traversant.



POLARIS			MATIÈRE	LED	T°	LED Lumen	System Lumen	L (mm)	€	
POL112N	NEW	BLANC	POLYCARBONATE	20W	4000K	2790 Lm	2600 Lm	1200	52,00	B
POL212N	NEW	BLANC	POLYCARBONATE	34W	4000K	4940 Lm	4700 Lm	1200	56,00	B
POL115N	NEW	BLANC	POLYCARBONATE	30W	4000K	4190 Lm	4000 Lm	1500	62,00	B
POL215N	NEW	BLANC	POLYCARBONATE	50W	4000K	7270 Lm	6750 Lm	1500	66,00	B



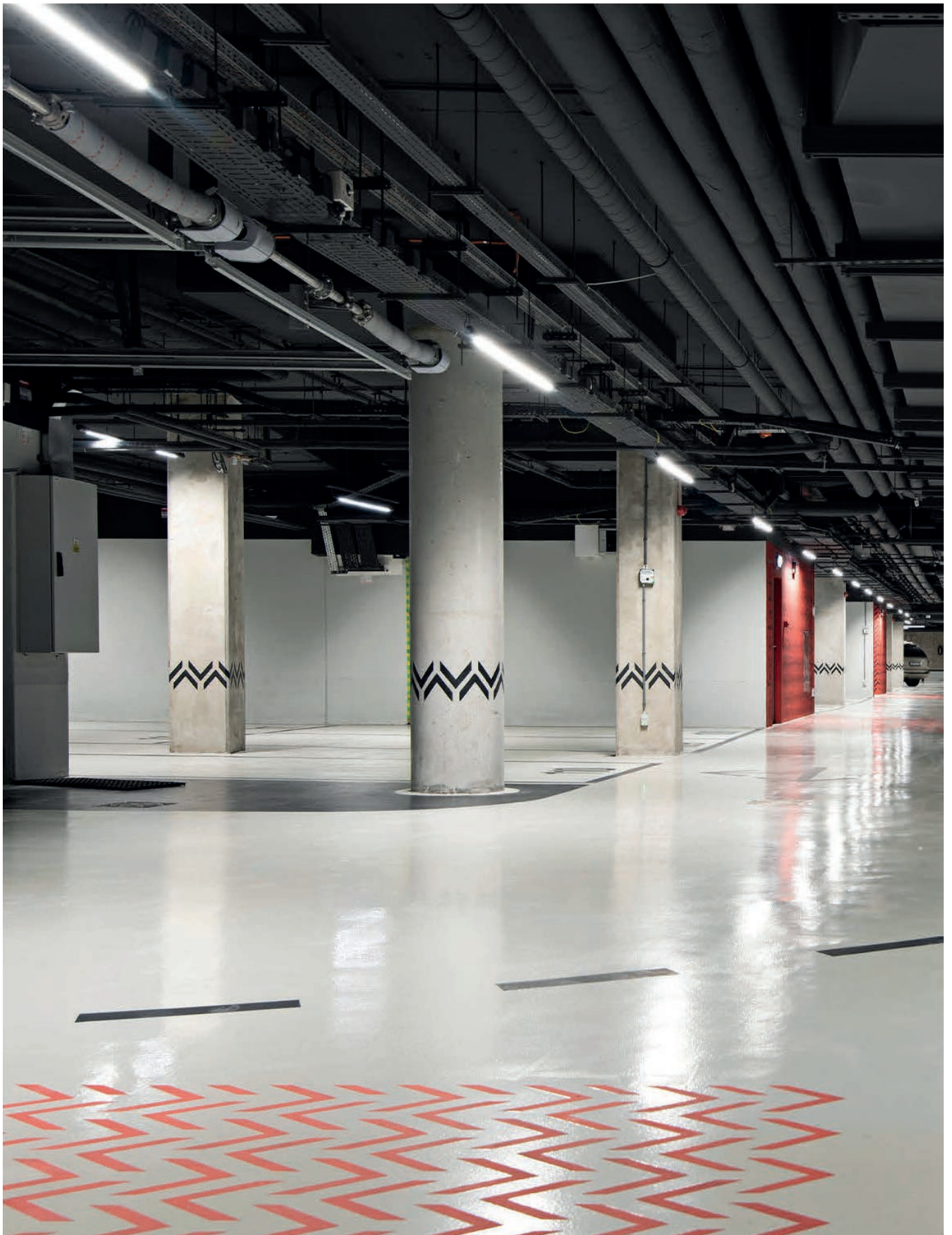

# INDIGO

---

LIGHTING



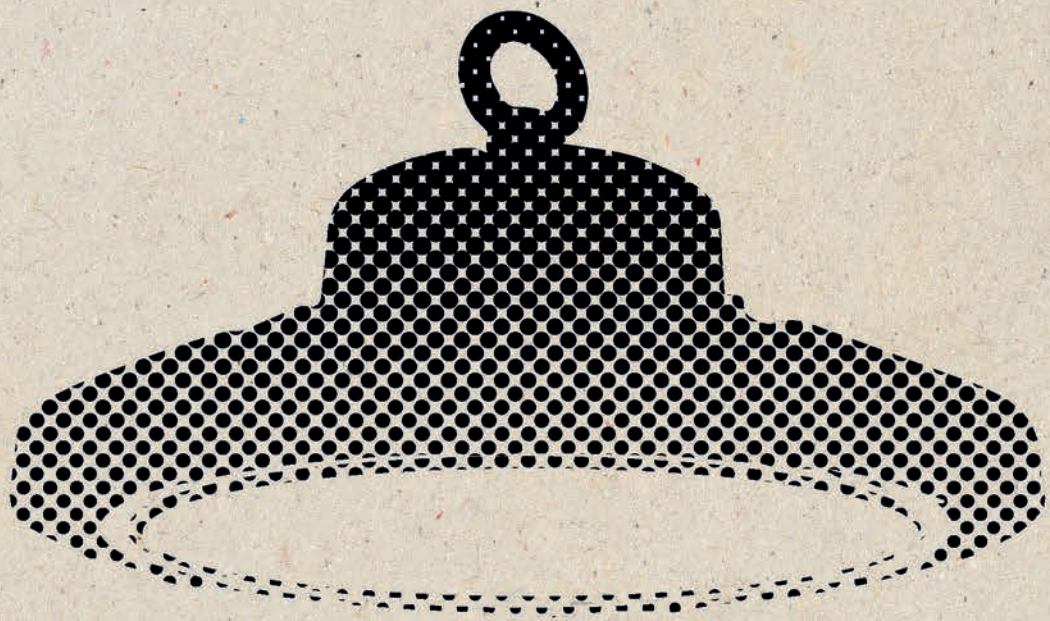

**HIGH BAY**

## LENTUS

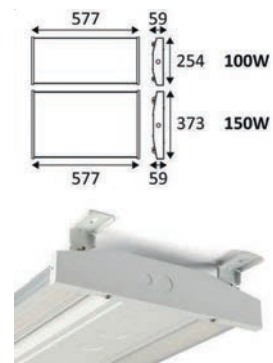
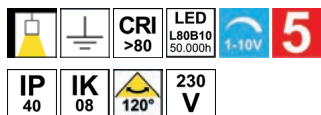

- Luminaire industriel.
- 0,40m de câble H05RN-F et câbles de suspension inclus.
- Convertisseur dimmable 1-10V / PWM intégré dans l'appareil.
- Accessoires en option : kit de montage en saillie, lentilles pour faisceau 50°x90°, détecteur HF de mouvement et de luminosité, commande à distance permettant de paramétrer le(s) détecteur(s).
- Paramétrage du détecteur : possibilité de régler la durée d'allumage, le capteur de luminosité, la zone de détection, le niveau de gradation en veille, la période de veille et la luminosité.

LENTUS		MATIÈRE	LED	T°	System Lumen	L (mm)	€
LB10040	NEW BLANC	ALUMINIUM	100W	4000K	15000 Lm	254	294,00 A
LB15040	NEW BLANC	ALUMINIUM	150W	4000K	22000 Lm	374	406,90 A

ACCESSOIRES	DESCRIPTION	L (mm)	€
LBACM	NEW KIT DE MONTAGE EN SAILLIE		177,40 A
LBAL5090	NEW LENTILLES FAISCEAU 50°x90°	575	12,70 A
LBASDHS	NEW DETECTEUR DE MOUVEMENT & LUMINOSITE		185,40 A
HBASDHSRC	NEW COMMANDE A DISTANCE POUR DETECTEUR		84,00 A





## SPRINGBOK LITE 1

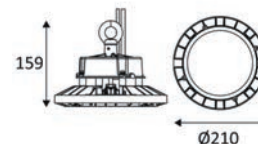
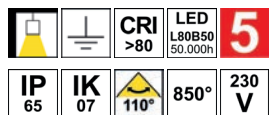

- Suspension industrielle pour grandes hauteurs.
  - Diffuseur en verre trempé.
  - Câble d'alimentation H05RN-F noir 1.50m et boucle de suspension M10 inclus.
  - Convertisseur non dimmable intégré dans l'appareil.
  - Installation possible jusqu'à une hauteur de 15m.
  - Accessoires en option : étrier de fixation réglable 270°, réflecteur prismatique 80°, détecteur hyperfréquence et commande à distance permettant de paramétrer le(s) détecteur(s).
  - Réglages par défaut du détecteur hyperfréquence : durée d'allumage 5 sec., capteur de luminosité désactivé, zone de détection 100%.
- La commande à distance est nécessaire pour paramétrer d'autres réglages.

SPRINGBOK LITE 1		MATIÈRE	LED	T°	LED Lumen	System Lumen	€
HB100WW05	<b>NEW</b> NOIR	FONTE D'ALUMINIUM	80W	3000K	12350 Lm	8715 Lm	126,50 B
HB100NW05	<b>NEW</b> NOIR	FONTE D'ALUMINIUM	80W	4000K	13150 Lm	9865 Lm	126,50 B

ACCESSOIRES		DESCRIPTION		€
HB105	<b>NEW</b>	REFLECTEUR 80° PC PRISMATIQUE 309x160mm		51,50 B
HB104	<b>NEW</b> NOIR	ETRIER DE FIXATION REGLABLE 270°		22,50 B
HB103	<b>NEW</b> NOIR	KIT DETECTEUR HYPERFREQUENCE IP65		139,50 B
HB115	<b>NEW</b>	COMMANDE A DISTANCE POUR DETECTEUR HF		88,00 B



## SPRINGBOK LITE 2

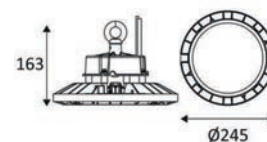
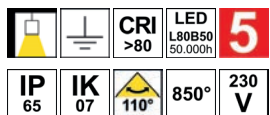

- Suspension industrielle pour grandes hauteurs.
  - Diffuseur en verre trempé.
  - Câble d'alimentation H05RN-F noir 1.50m et boucle de suspension M10 inclus.
  - Convertisseur non dimmable intégré dans l'appareil.
  - Installation possible jusqu'à une hauteur de 15m.
  - Accessoires en option : étrier de fixation réglable 270°, réflecteur prismatique 80°, détecteur hyperfréquence et commande à distance permettant de paramétrer le(s) détecteur(s).
  - Réglages par défaut du détecteur hyperfréquence : durée d'allumage 5 sec., capteur de luminosité désactivé, zone de détection 100%.
- La commande à distance est nécessaire pour paramétrer d'autres réglages.

SPRINGBOK LITE 2		MATIÈRE	LED	T°	LED Lumen	System Lumen	€
HB101WW05	<b>NEW</b> NOIR	FONTE D'ALUMINIUM	150W	3000K	22150 Lm	18105 Lm	151,00 B
HB101NW05	<b>NEW</b> NOIR	FONTE D'ALUMINIUM	150W	4000K	23550 Lm	19130 Lm	151,00 B

ACCESSOIRES		DESCRIPTION		€
HB106	<b>NEW</b>	REFLECTEUR 80° PC PRISMATIQUE 413x250mm		77,50 B
HB104	<b>NEW</b> NOIR	ETRIER DE FIXATION REGLABLE 270°		22,50 B
HB103	<b>NEW</b> NOIR	KIT DETECTEUR HYPERFREQUENCE IP65		139,50 B
HB115	<b>NEW</b>	COMMANDE A DISTANCE POUR DETECTEUR HF		88,00 B

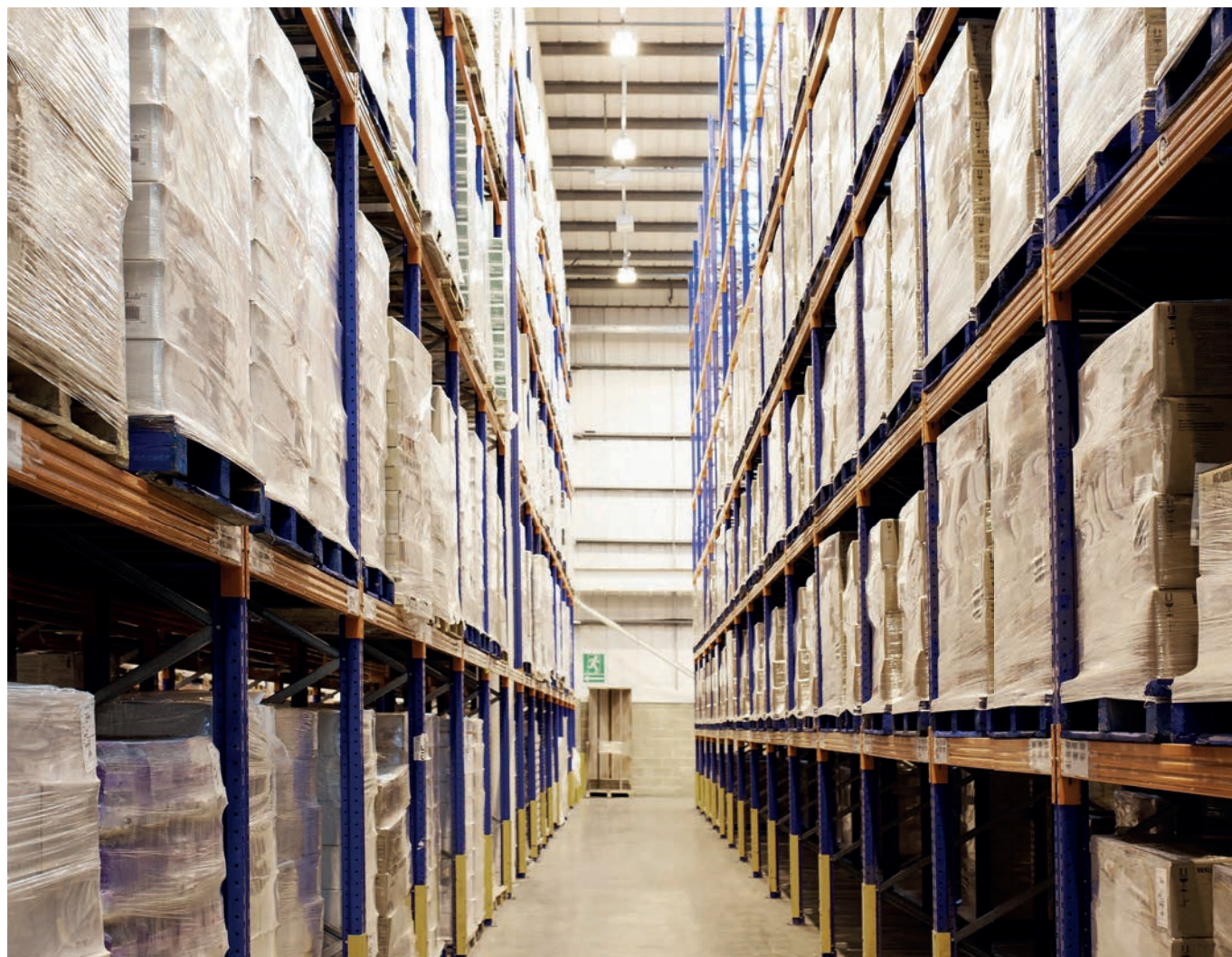





## SPRINGBOK LITE 3

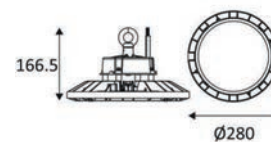
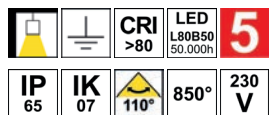

NEW



- Suspension industrielle pour grandes hauteurs.
  - Diffuseur en verre trempé.
  - Câble d'alimentation H05RN-F noir 1.50m et boucle de suspension M10 inclus.
  - Convertisseur non dimmable intégré dans l'appareil.
  - Installation possible jusqu'à une hauteur de 15m.
  - Accessoires en option : étrier de fixation réglable 270°, réflecteur prismatique 80°, détecteur hyperfréquence et commande à distance permettant de paramétrer le(s) détecteur(s).
  - Réglages par défaut du détecteur hyperfréquence : durée d'allumage 5 sec., capteur de luminosité désactivé, zone de détection 100%.
- La commande à distance est nécessaire pour paramétrer d'autres réglages.

SPRINGBOK LITE 3		MATIÈRE	LED	T°	LED Lumen	System Lumen	€	
HB102WW05	<b>NEW</b>	NOIR	FRONTE D'ALUMINIUM	200W	3000K	29200 Lm	24970 Lm	175,00 B
HB102NW05	<b>NEW</b>	NOIR	FRONTE D'ALUMINIUM	200W	4000K	31050 Lm	25015 Lm	175,00 B

ACCESSOIRES		DESCRIPTION		€
HB107	<b>NEW</b>	REFLECTEUR 80° PC PRISMATIQUE 413x230mm		82,00 B
HB104	<b>NEW</b>	ETRIER DE FIXATION REGLABLE 270°		22,50 B
HB103	<b>NEW</b>	KIT DETECTEUR HYPERFREQUENCE IP65		139,50 B
HB115	<b>NEW</b>	COMMANDE A DISTANCE POUR DETECTEUR HF		88,00 B



## EAZY

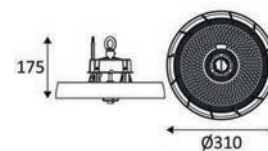
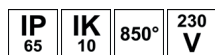

- Suspension industrielle pour grandes hauteurs.
  - Diffuseur en polycarbonate.
  - Câble d'alimentation H05RN-F noir 1.50m, câble pour variation 0.20m et boucle de suspension M10 inclus.
  - Multi-puissance : 100, 150 ou 200W au choix via un interrupteur à l'arrière du luminaire.
  - Convertisseur dimmable 0-10V intégré dans l'appareil.
  - Installation possible jusqu'à une hauteur de 15m.
  - Accessoires en option : étrier de fixation réglable 270°, grille de protection, réflecteur polycarbonate, détecteur hyperfréquence et commande à distance permettant de paramétrer le(s) détecteur(s).
  - Réglages par défaut du détecteur hyperfréquence : durée d'allumage 10 min., capteur de luminosité 50 Lux, zone de détection 100%, gradation du mode veille 30%, période de veille continue.
- La commande à distance est nécessaire pour paramétrer d'autres réglages.

EAZY		MATIÈRE	LED	T°	LED Lumen	System Lumen	α	€
HB111WW05	NEW	NOIR	FONTE D'ALUMINIUM	100W 150W 200W	3000K	19850 Lm 28900 Lm 36700 Lm	15900 Lm 22780 Lm 29275 Lm	60° 211,00 B
HB111NW05	NEW	NOIR	FONTE D'ALUMINIUM	100W 150W 200W	4000K	20850 Lm 30450 Lm 38650 Lm	16710 Lm 23980 Lm 30870 Lm	60° 211,00 B
HB112WW05	NEW	NOIR	FONTE D'ALUMINIUM	100W 150W 200W	3000K	19850 Lm 28900 Lm 36700 Lm	16395 Lm 23535 Lm 30275 Lm	90° 211,00 B
HB112NW05	NEW	NOIR	FONTE D'ALUMINIUM	100W 150W 200W	4000K	20850 Lm 30450 Lm 38650 Lm	17205 Lm 24730 Lm 31885 Lm	90° 211,00 B
HB108WW05	NEW	NOIR	FONTE D'ALUMINIUM	100W 150W 200W	3000K	19850 Lm 28900 Lm 36700 Lm	15335 Lm 21960 Lm 30320 Lm	110° 211,00 B
HB108NW05	NEW	NOIR	FONTE D'ALUMINIUM	100W 150W 200W	4000K	20850 Lm 30450 Lm 38650 Lm	16920 Lm 24480 Lm 32075 Lm	110° 211,00 B

ACCESSOIRES		DESCRIPTION		€
HB113	NEW	REFLECTEUR POLYCARBONATE 412x151mm		63,00 B
HB104	NEW	NOIR	ETRIER DE FIXATION REGLABLE 270°	22,50 B
HB110	NEW	BLANC	GRILLE DE PROTECTION	44,50 B
HB114	NEW	NOIR	DETECTEUR HYPERFREQUENCE IP65	60,50 B
HB115	NEW	COMMANDE A DISTANCE POUR DETECTEUR HF		88,00 B



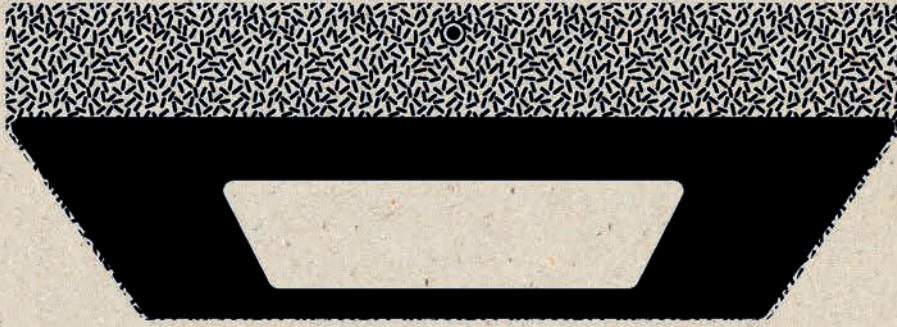

# INDIGO

LIGHTING

**LUMINAIRES  
EXTÉRIEURS**





**ENCASTRÉS DE SOL**

**SPOTS SUR PIQUETS**

**BORNES**

**ENCASTRÉS MURAUX**

**APPLIQUES**

**PLAFONNIERS**

**PROJECTEURS**

**SPOTS**

**NEW**

**RÉGLETTES WALL-WASHER**

**SOLAIRES**

**MOBILES**

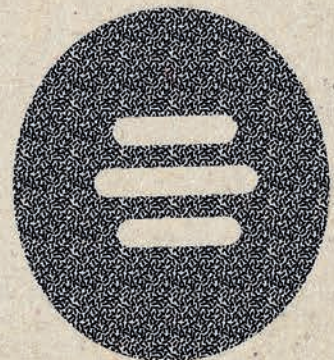

# INDIGO

LIGHTING

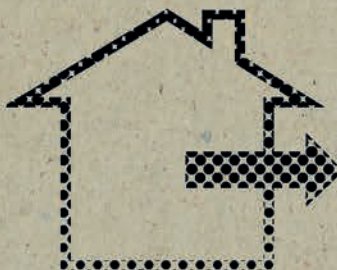



## **ENCASTRÉS DE SOL**

**KO2000 R GU10**

- Encastré de sol rond.
- Boîtier d'encastrement fourni.
- Système de relamping simple et rapide.
- Carrossable résistance 1000kg.
- Double presse étoupe.

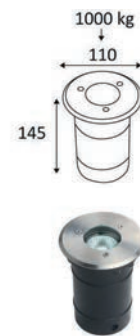

KO2000 R GU10	MATIÈRE	SOCKET	LAMPE	Watt Max	€
KO2000R	INOX 304	GU10	PAR16 LED	10W	86,50 B
KO2000R16	INOX 316	GU10	PAR16 LED	10W	114,30 B

**KO2000 S GU10**

- Encastré de sol carré.
- Boîtier d'encastrement fourni.
- Système de relamping simple et rapide.
- Carrossable résistance 1000kg.
- Double presse-étoupe.

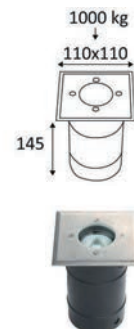

KO2000 S GU10	MATIÈRE	SOCKET	LAMPE	Watt Max	€
KO2000S	INOX 304	GU10	PAR16 LED	10W	139,10 B
KO2000S16	INOX 316	GU10	PAR16 LED	10W	161,70 B





## WALKER E27



- Encastré de sol rond.
- Carrossable résistance 2000kg.
- Boîtier d'encastrement fourni.

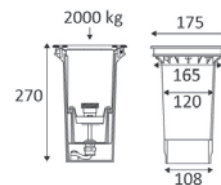

WALKER E27	MATIÈRE	SOCKET	LAMPE	Watt Max	€
OU27180	INOX 304	E27	LED	40W	102,00 B



## MINI 6

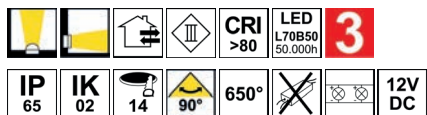

- Mini encastré de sol rond.
- LED blanche (3000K, 6000K) ou bleue (BL).
- 1.50m de câble fourni.
- Convertisseur 12Vdc à commander séparément.

Max. 80 MINI 6 par CD171.

ALIMENTATION(S)	Watt Max	€
CD171	0-20W	45,30 B

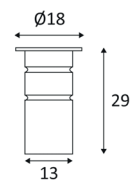

MINI 6	MATIÈRE	LED	T°	LED Lumen	System Lumen	€
KO91WW	ALUMINIUM	0,12W	3000K	15 Lm	6 Lm	34,00 B
KO91CL	ALUMINIUM	0,12W	6000K	15 Lm	6 Lm	34,00 B
KO91BL	ALUMINIUM	0,12W	BL	-	-	34,00 B



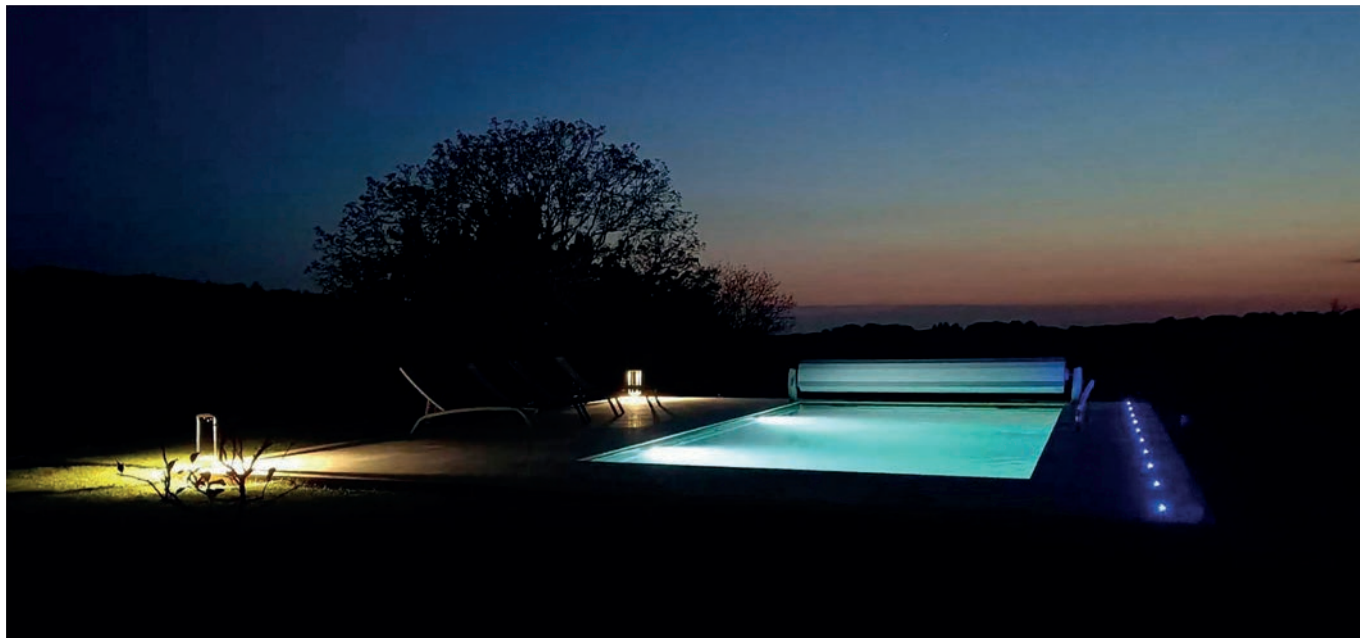

## TINY R

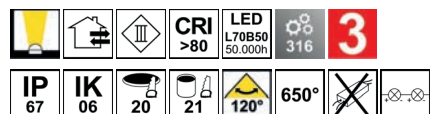

- Encastré de sol rond.
- Diffuseur opalin.
- LED blanche (4000K) ou bleue (BL).
- Carrossable résistance 650kg.
- Boîtier d'encastrement et 1.00m de câble fournis.
- Convertisseur 350mA à commander séparément.

Max. 14 TINY par CD114.

ALIMENTATION(S)	Watt Max	€
CD114	2-18W	45,30 B

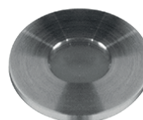

TINY R	MATIÈRE	LED	T°	LED Lumen	System Lumen	€
OU16816	INOX 316	1W	4000K	150 Lm	80 Lm	78,30 B
OU26116	INOX 316	1W	BL	-	-	78,30 B



## PURE 45

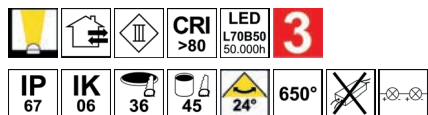

- Encastré de sol rond.
- Boîtier d'encastrement et 0.50m de câble fournis.
- Convertisseur 700mA à commander séparément.

Max. 11 PURE 45 par CD105.

ALIMENTATION(S)	Watt Max	€
CD172	2-4W	15,50 B
CD105	9-35W	95,80 B



PURE 45	MATIÈRE	LED	T°	LED Lumen	System Lumen	€
OU125	ALUMINIUM	3W	4000K	200 Lm	124 Lm	116,40 B

## PURE 55

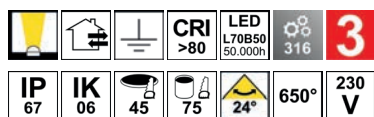

- Encastré de sol rond.
- Carrossable résistance 1500kg.
- Boîtier d'encastrement, clips de montage et 1.00m de câble fournis.
- Convertisseur non dimmable intégré dans l'appareil.



PURE 55	MATIÈRE	LED	T°	LED Lumen	System Lumen	€
OU16116	INOX 316	3W	4000K	250 Lm	172 Lm	154,50 B

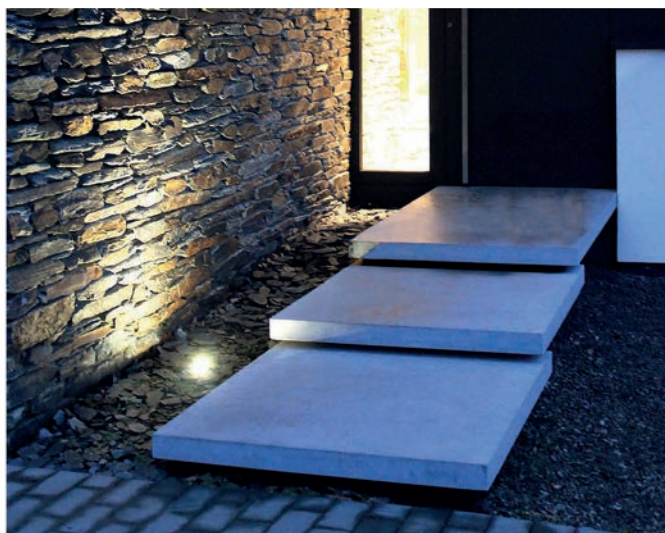

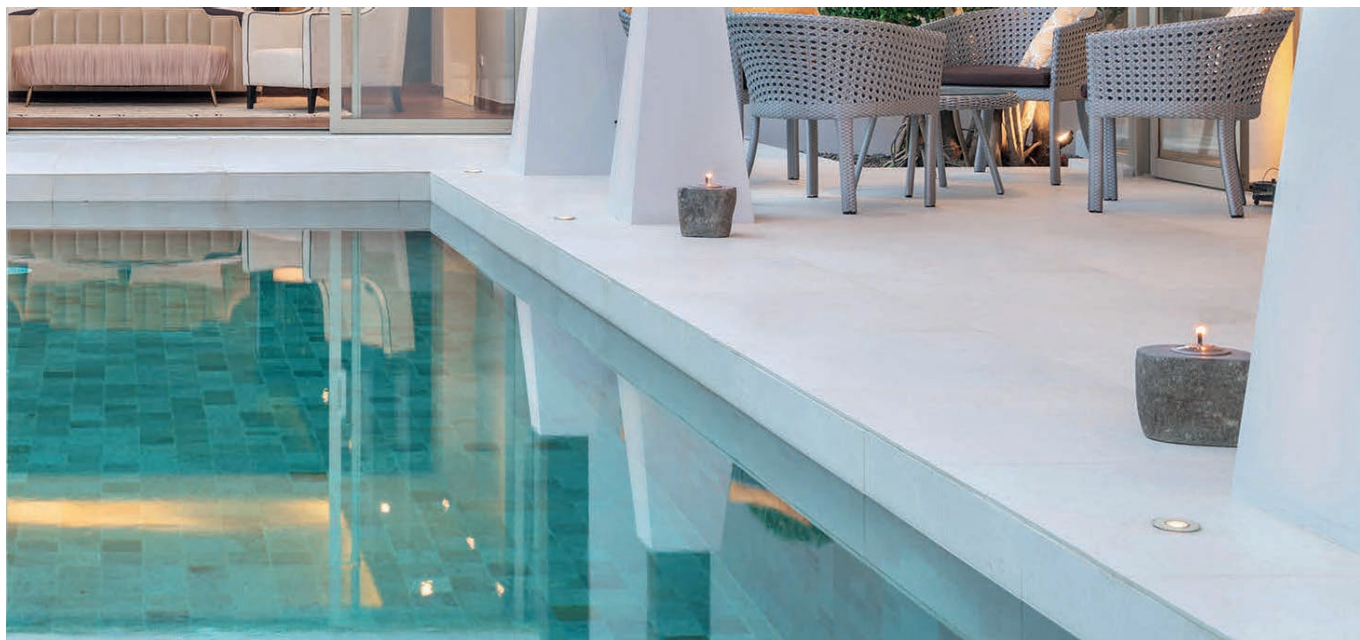

## SWIM

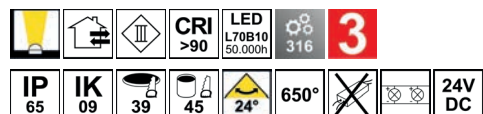

- Encastré de sol rond.
- Boîtier d'encastrement et 0.35m de câble fournis.
- Convertisseur 24Vdc à commander séparément.

ALIMENTATION(S)		Watt Max	€
CD178	NEW	75W	72,30 A
CD179	NEW	100W	121,70 A
CD180	NEW	150W	125,10 A
CD181	NEW	250W	221,70 A



SWIM	MATIÈRE	LED	T°	LED Lumen	System Lumen	€
OU486WW16	INOX 316	5W	3000K	195 Lm	125 Lm	87,60 B

## WALLY A

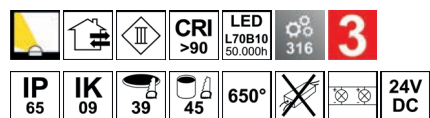

- Encastré de sol rond.
- Wall washer.
- Boîtier d'encastrement et 0.35m de câble fournis.
- Convertisseur 24Vdc à commander séparément.

ALIMENTATION(S)		Watt Max	€
CD178	NEW	75W	72,30 A
CD179	NEW	100W	121,70 A
CD180	NEW	150W	125,10 A
CD181	NEW	250W	221,70 A



WALLY A	MATIÈRE	LED	T°	LED Lumen	System Lumen	€
OU488WW16	INOX 316	5W	3000K	195 Lm	100 Lm	96,80 B

## PURE 380

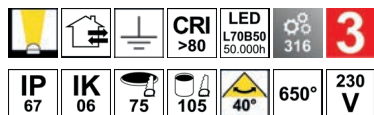

- Encastré de sol rond.
- Carrossable résistance 1200kg.
- Boîtier d'encastrement et 0.50m de câble fournis.
- Convertisseur non dimmable intégré dans l'appareil.

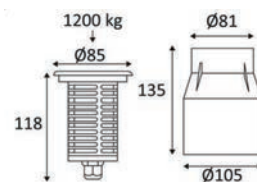

PURE 380	MATIÈRE	LED	T°	LED Lumen	System Lumen	€
PU637WW	INOX 316	7W	3000K	540 Lm	393 Lm	239,00 B
OU263NW16	INOX 316	7W	4000K	620 Lm	483 Lm	239,00 B





## APA RD-230

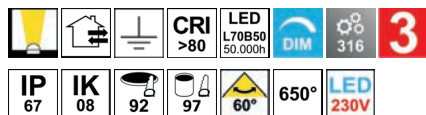

- Encastré de sol rond.
- Carrossable résistance 1500kg.
- Avec grille nid d'abeille amovible.
- Boîtier d'encastrement et 1.00m de câble fournis.
- Dimmable.

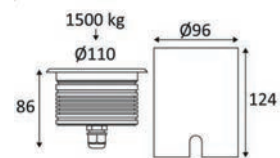

APA RD-230	MATIÈRE	LED	T°	LED Lumen	System Lumen	€
OU326WW16	INOX 316	8W	3000K	550 Lm	352 Lm	179,20 B
OU326NW16	INOX 316	8W	4000K	600 Lm	407 Lm	179,20 B



## BIG APA RD-230

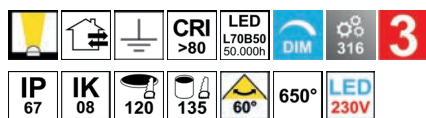

- Encastré de sol rond.
- Carrossable résistance 1500kg.
- Avec grille nid d'abeille amovible.
- Boîtier d'encastrement et 1.00m de câble fournis.
- Dimmable.

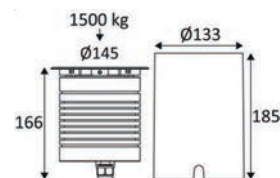

BIG APA RD-230	MATIÈRE	LED	T°	LED Lumen	System Lumen	€
OU411WW16	INOX 316	20W	3000K	1860 Lm	1436 Lm	283,30 B
OU411NW16	INOX 316	20W	4000K	1940 Lm	1534 Lm	283,30 B

## GYRO

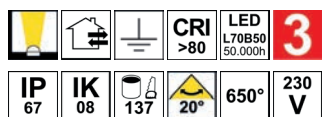

- Encastré de sol rond.
- Boîtier d'encastrement et 1.00m de câble fournis.
- Convertisseur non dimmable intégré dans l'appareil.

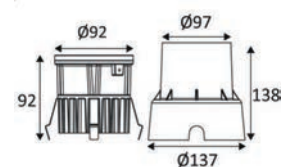

GYRO		MATIÈRE	LED	T°	LED Lumen	System Lumen	€
OU425WW05	■ NOIR	VERRE	6W	3000K	500 Lm	450 Lm	190,60 B
OU425NW05	■ NOIR	VERRE	6W	4000K	550 Lm	490 Lm	190,60 B







## GYRO A



- Encastré de sol rond.
- Wall washer.
- Boîtier d'encastrement et 1.00m de câble fournis.
- Convertisseur non dimmable intégré dans l'appareil.

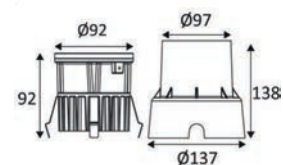

GYRO A		MATIÈRE	LED	T°	LED Lumen	System Lumen	€
OU426WW05	■ NOIR	VERRE	8W	3000K	500 Lm	155 Lm	190,60 B
OU426NW05	■ NOIR	VERRE	8W	4000K	550 Lm	180 Lm	190,60 B

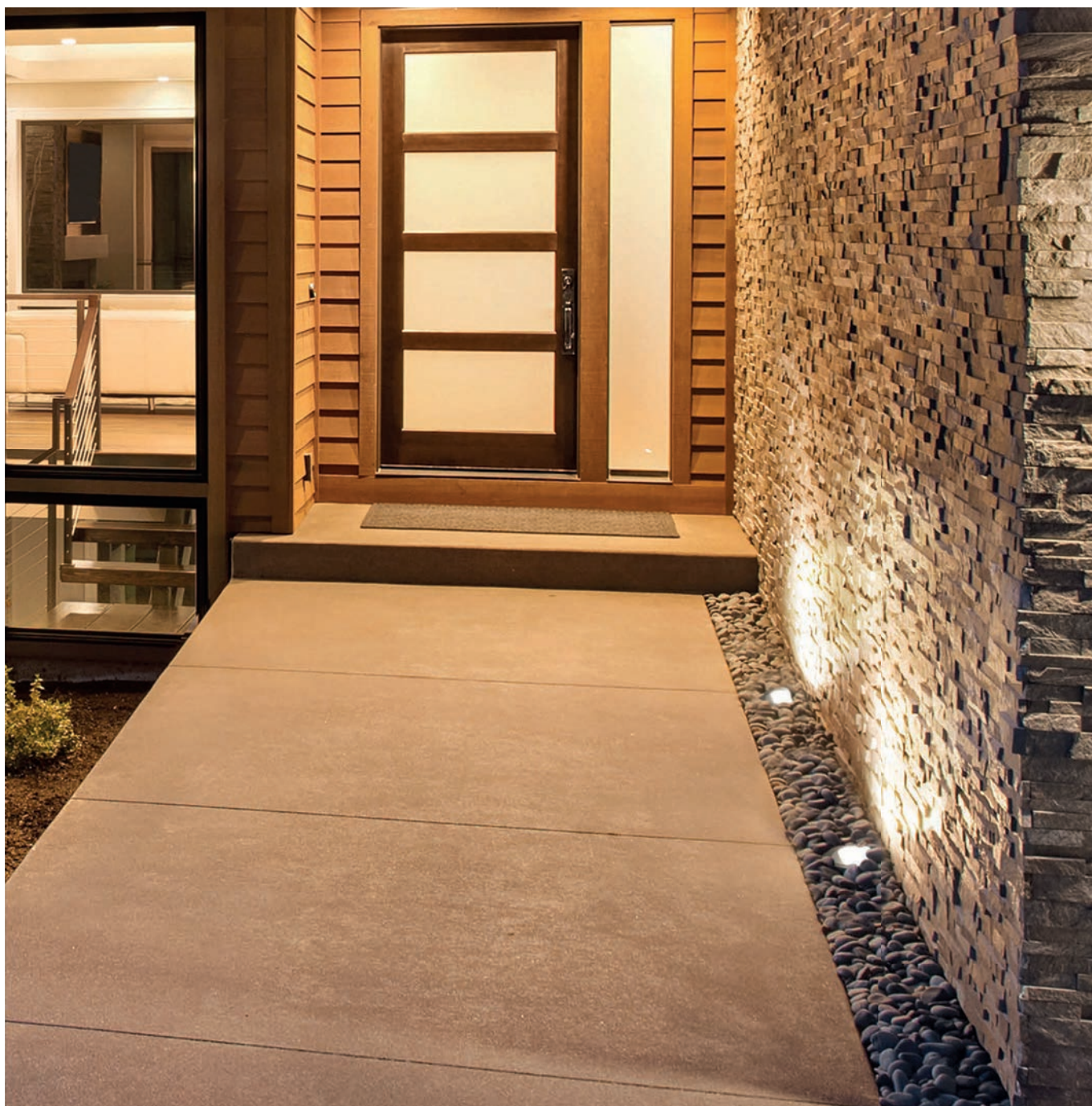

## RODI A

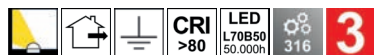

- Encastré de sol rond.
- Wall washer.
- Carrossable résistance 2000kg.
- Boîtier d'encastrement et 2.00m de câble fournis.
- Convertisseur non dimmable intégré dans l'appareil.

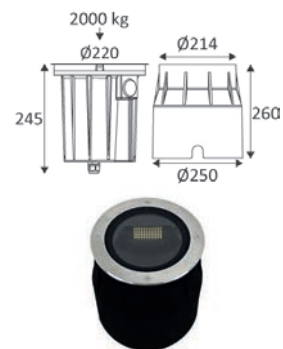

RODI A	MATIÈRE	LED	T°	LED Lumen	System Lumen	€
OU427WW16	INOX 316	20W	3000K	2100 Lm	1610 Lm	654,10 B

## BIG RODI A

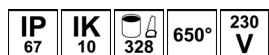
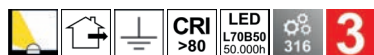

- Encastré de sol rond.
- Wall washer.
- Carrossable résistance 2000kg.
- Boîtier d'encastrement et 2.00m de câble fournis.
- Convertisseur non dimmable intégré dans l'appareil.



BIG RODI A	MATIÈRE	LED	T°	LED Lumen	System Lumen	€
OU428WW16	INOX 316	30W	3000K	2800 Lm	2635 Lm	780,70 B



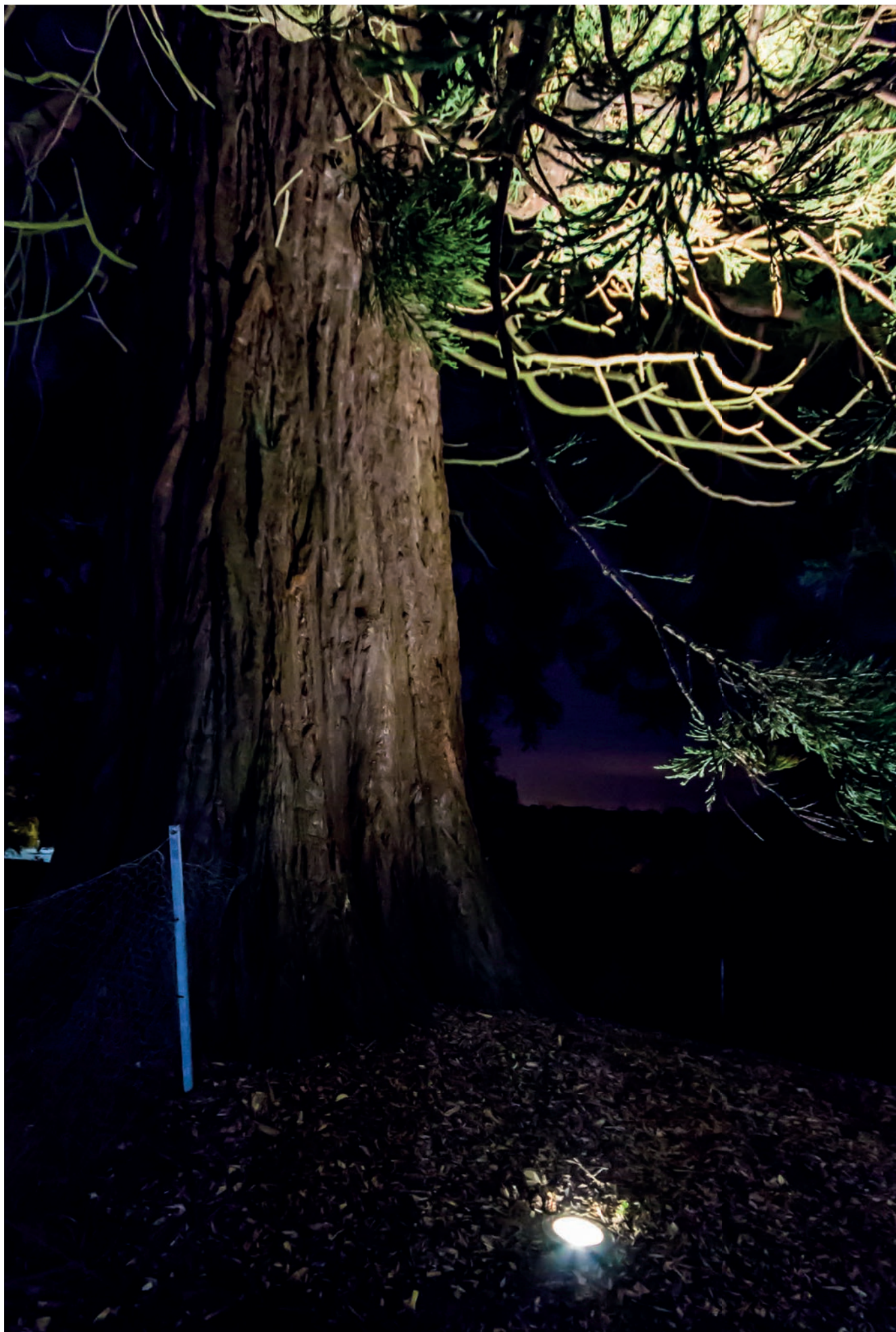

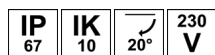
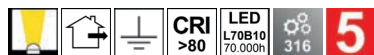
**GL09**

- Encastré de sol rond avec sources orientables.
- Diffuseur en verre clair.
- Carrossable résistance 2000kg (max 24km/h).
- Inox 316 pour les zones côtières.
- Pot d'encastrement et 1m de câble H05RN-F (diamètre 7mm) fournis.
- Convertisseur non dimmable intégré dans l'appareil.
- Boîte de connexion étanche à commander séparément.

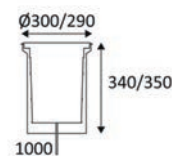

GL09	MATIÈRE	LED	T°	System Lumen	α	€
GL09D38X30	<b>NEW</b> INOX 316	25,5W	3000K	2085 Lm	38°	1.320,00 A
GL09D60X30	<b>NEW</b> INOX 316	25,5W	3000K	2085 Lm	60°	1.320,00 A

ACCESSOIRES	DESCRIPTION	€
JB5	<b>NEW</b> BOITE DE CONNEXION PARALLELE AVEC GEL IP68	 54,70 A
WC59	<b>NEW</b> CONNECTEUR IP68	 85,20 A

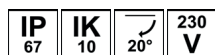
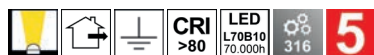
**GL08**

- Encastré de sol rond avec sources orientables.
- Diffuseur en verre clair.
- Carrossable résistance 2000kg (max 24km/h).
- Inox 316 pour les zones côtières.
- Pot d'encastrement et 1m de câble H05RN-F (diamètre 7mm) fournis.
- Convertisseur non dimmable intégré dans l'appareil.
- Boîte de connexion étanche à commander séparément.

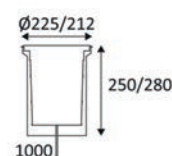

GL08	MATIÈRE	LED	T°	System Lumen	α	€
GL08D24X30	<b>NEW</b> INOX 316	17W	3000K	1390 Lm	24°	884,00 A
GL08D38X30	<b>NEW</b> INOX 316	17W	3000K	1390 Lm	38°	884,00 A
GL08D60X30	<b>NEW</b> INOX 316	17W	3000K	1390 Lm	60°	884,00 A

ACCESSOIRES	DESCRIPTION	€
JB5	<b>NEW</b> BOITE DE CONNEXION PARALLELE AVEC GEL IP68	 54,70 A
WC59	<b>NEW</b> CONNECTEUR IP68	 85,20 A

## GL07

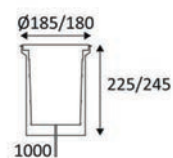
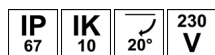
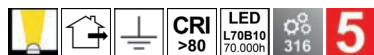

- Encastré de sol rond avec source orientable.
- Diffuseur en verre clair.
- Carrossable résistance 2000kg (max 24km/h).
- Inox 316 pour les zones côtières.
- Pot d'encastrement et 1m de câble H05RN-F (diamètre 7mm) fournis.
- Convertisseur non dimmable intégré dans l'appareil.
- Boîte de connexion étanche à commander séparément.

GL07	MATIÈRE	LED	T°	System Lumen	α	€
GL07D24X30	<b>NEW</b> INOX 316	8,5W	3000K	695 Lm	24°	623,00 A
GL07D24X40	<b>NEW</b> INOX 316	8,5W	4000K	695 Lm	24°	623,00 A
GL07D38X30	<b>NEW</b> INOX 316	8,5W	3000K	695 Lm	38°	623,00 A
GL07D38X40	<b>NEW</b> INOX 316	8,5W	4000K	695 Lm	38°	623,00 A
GL07D60X30	<b>NEW</b> INOX 316	8,5W	3000K	695 Lm	60°	623,00 A
GL07D60X40	<b>NEW</b> INOX 316	8,5W	4000K	695 Lm	60°	623,00 A

ACCESSOIRES	DESCRIPTION	€
JB5	<b>NEW</b> BOITE DE CONNEXION PARALLELE AVEC GEL IP68	 54,70 A
WC59	<b>NEW</b> CONNECTEUR IP68	 85,20 A





## GL06

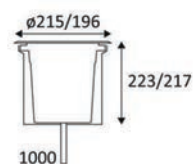
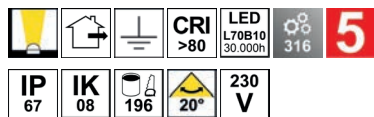

- Encastré de sol rond.
- Diffuseur en verre clair.
- Carrossable.
- Inox 316 pour les zones côtières.
- Pot d'encastrement et 1m de câble H05RN-F (diamètre 7mm) fournis.
- Convertisseur non dimmable intégré dans l'appareil.
- Boîte de connexion étanche à commander séparément.

GL06	MATIÈRE	LED	T°	LED Lumen	System Lumen	L (mm)	€
GL06X30	<b>NEW</b> INOX 316	21W	3000K	1650 Lm	970 Lm	215	596,90 A

ACCESSOIRES	DESCRIPTION	€
JB5	<b>NEW</b> BOITE DE CONNEXION PARALLELE AVEC GEL IP68	54,70 A
WC59	<b>NEW</b> CONNECTEUR IP68	85,20 A

## GL045

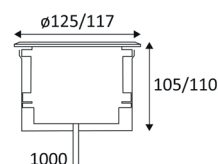
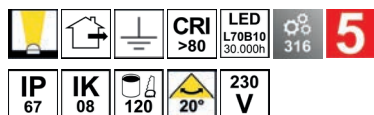

- Encastré de sol rond.
- Diffuseur en verre clair.
- Pot d'encastrement et 1m de câble H05RN-F (diamètre 7mm) fournis.
- Convertisseur non dimmable intégré dans l'appareil.
- Boîte de connexion étanche à commander séparément.

GL045	MATIÈRE	LED	T°	LED Lumen	System Lumen	€
GL045X30	<b>NEW</b> INOX 316	8,1W	3000K	750 Lm	610 Lm	256,60 A

ACCESSOIRES	DESCRIPTION	€
JB5	<b>NEW</b> BOITE DE CONNEXION PARALLELE AVEC GEL IP68	54,70 A
WC59	<b>NEW</b> CONNECTEUR IP68	85,20 A

**NEW**

## GL040

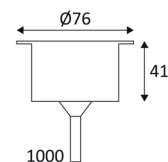
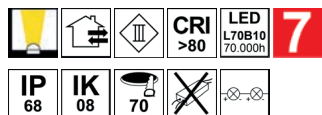

- Encastré de sol rond.
- Diffuseur en verre clair.
- Versions inox 316 pour les zones côtières.
- 1m de câble H05RN-F fourni (diamètre 6mm).
- Convertisseur 350mA ou 700mA à commander séparément.
- Tube d'encastrement et boîte de raccordement étanche à commander séparément.

GL040	MATIÈRE	LED	T°	System Lumen	α	€
GL040DNBX27	<b>NEW</b> INOX 316	2,2W (350mA) 4,6W (700mA)	2700K	310 Lm (350mA) 515 Lm (700mA)	12°	237,50 A
GL040DNBX30	<b>NEW</b> INOX 316	2,2W (350mA) 4,6W (700mA)	3000K	290 Lm (350mA) 520 Lm (700mA)	12°	237,50 A
GL040DNBX40	<b>NEW</b> INOX 316	2,2W (350mA) 4,6W (700mA)	4000K	300 Lm (350mA) 530 Lm (700mA)	12°	237,50 A
GL040ANBX27	<b>NEW</b> LAITON ANTIQUE	2,2W (350mA) 4,6W (700mA)	2700K	290 Lm (350mA) 515 Lm (700mA)	12°	352,40 A
GL040ANBX30	<b>NEW</b> LAITON ANTIQUE	2,2W (350mA) 4,6W (700mA)	3000K	300 Lm (350mA) 520 Lm (700mA)	12°	352,40 A
GL040DWBX27	<b>NEW</b> INOX 316	2,2W (350mA) 4,6W (700mA)	2700K	290 Lm (350mA) 515 Lm (700mA)	40°	237,50 A
GL040DWBX30	<b>NEW</b> INOX 316	2,2W (350mA) 4,6W (700mA)	3000K	290 Lm (350mA) 520 Lm (700mA)	40°	237,50 A
GL040DWBX40	<b>NEW</b> INOX 316	2,2W (350mA) 4,6W (700mA)	4000K	300 Lm (350mA) 530 Lm (700mA)	40°	237,50 A
GL040AWBX27	<b>NEW</b> LAITON ANTIQUE	2,2W (350mA) 4,6W (700mA)	2700K	290 Lm (350mA) 515 Lm (700mA)	40°	352,40 A
GL040AWBX30	<b>NEW</b> LAITON ANTIQUE	2,2W (350mA) 4,6W (700mA)	3000K	300 Lm (350mA) 520 Lm (700mA)	40°	352,40 A

ACCESSOIRES	MATIÈRE	DESCRIPTION	L (mm)	€
GLA01	<b>NEW</b> INOX 316	BAGUE CARREE 94x94mm	94	72,00 A
TUBE68	<b>NEW</b> ALUMINIUM	TUBE D'ENCASTREMENT 72x150mm	150	48,00 A
PSIP3509W	<b>NEW</b>	DRIVER 1-9W 350mA CC IP65	149	44,00 A
PSIP35018W	<b>NEW</b>	DRIVER 9-18W 350mA CC IP65	149	57,70 A
PSIP70018W	<b>NEW</b>	DRIVER 2-18W 700mA CC IP65	149	56,10 A
PSIP70036W	<b>NEW</b>	DRIVER 18-36W 700mA CC IP65	162	73,40 A
JB2	<b>NEW</b>	BOITE DE RACCORDEMENT SERIE 3 SORTIES IP68		13,60 A
JB4	<b>NEW</b>	BOITE DE CONNEXION SERIE AVEC GEL IP68		54,70 A
JB6	<b>NEW</b>	CONNECTEUR AVEC GEL IP68		29,60 A







## GL040 ULG

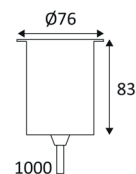
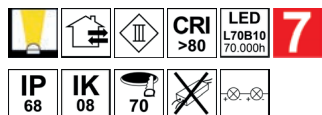

- Encastré de sol rond.
- Très basse luminance.
- Versions inox 316 pour les zones côtières.
- 1m de câble H05RN-F fourni (diamètre 6mm).
- Convertisseur 350mA à commander séparément.
- Tube d'encastrement et boîte de raccordement étanche à commander séparément.

GL040 ULG	MATIÈRE	LED	T°	LED Lumen	System Lumen	α	€
GL040DNBL27	<b>NEW</b> INOX 316	2W	2700K	240 Lm	200 Lm	12°	292,70 A
GL040DNBL30	<b>NEW</b> INOX 316	2W	3000K	270 Lm	208 Lm	12°	292,70 A
GL040ANBL27	<b>NEW</b> LAITON ANTIQUE	2W	2700K	240 Lm	200 Lm	12°	447,30 A
GL040ANBL30	<b>NEW</b> LAITON ANTIQUE	2W	3000K	270 Lm	208 Lm	12°	447,30 A
GL040DMBL27	<b>NEW</b> INOX 316	2W	2700K	240 Lm	200 Lm	34°	292,70 A
GL040DMBL30	<b>NEW</b> INOX 316	2W	3000K	270 Lm	208 Lm	34°	292,70 A
GL040DMBL40	<b>NEW</b> INOX 316	2W	4000K	280 Lm	215 Lm	34°	292,70 A
GL040AMBL27	<b>NEW</b> LAITON ANTIQUE	2W	2700K	240 Lm	200 Lm	34°	447,30 A
GL040AMBL30	<b>NEW</b> LAITON ANTIQUE	2W	3000K	270 Lm	208 Lm	34°	447,30 A

ACCESSOIRES	MATIÈRE	DESCRIPTION	L (mm)	€
GLA01	<b>NEW</b> INOX 316	BAGUE CARREE 94x94mm	94	72,00 A
TUBE68	<b>NEW</b> ALUMINIUM	TUBE D'ENCASTREMENT 72x150mm	150	48,00 A
PSIP3509W	<b>NEW</b>	DRIVER 1-9W 350mA CC IP65	149	44,00 A
PSIP35018W	<b>NEW</b>	DRIVER 9-18W 350mA CC IP65	149	57,70 A
JB2	<b>NEW</b>	BOITE DE RACCORDEMENT SERIE 3 SORTIES IP68		13,60 A
JB4	<b>NEW</b>	BOITE DE CONNEXION SERIE AVEC GEL IP68		54,70 A
JB6	<b>NEW</b>	CONNECTEUR AVEC GEL IP68		29,60 A



## GL038

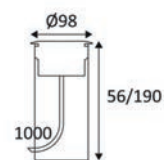
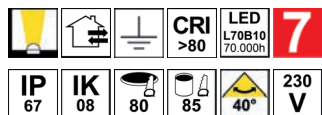

- Encastré de sol rond.
- Diffuseur en verre clair.
- Versions inox 316 pour les zones côtières.
- Pot d'encastrement et 1m de câble H05RN-F (diamètre 6mm) fournis.
- Convertisseur non dimmable intégré dans l'appareil.
- Boîte de connexion étanche à commander séparément.

GL038	MATIÈRE	LED	T°	System Lumen	€
GL038DWBM27	<b>NEW</b> INOX 316	2,9W	2700K	280 Lm	344,50 A
GL038DWBM30	<b>NEW</b> INOX 316	2,9W	3000K	290 Lm	344,50 A
GL038DWBM40	<b>NEW</b> INOX 316	2,9W	4000K	300 Lm	344,50 A
GL038AWBM27	<b>NEW</b> LAITON ANTIQUE	2,9W	2700K	280 Lm	552,80 A
GL038AWBM30	<b>NEW</b> LAITON ANTIQUE	2,9W	3000K	290 Lm	552,80 A

ACCESSOIRES	DESCRIPTION	€
JB5	<b>NEW</b> BOITE DE CONNEXION PARALLELE AVEC GEL IP68	54,70 A
WC59	<b>NEW</b> CONNECTEUR IP68	85,20 A





## GL019

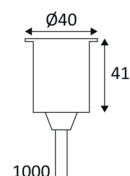
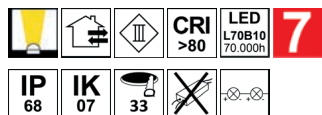

- Encastré de sol rond.
- Diffuseur en verre clair.
- Versions inox 316 pour les zones côtières.
- 1m de câble H05RN-F fourni (diamètre 6mm).
- Convertisseur 350mA ou 700mA à commander séparément.
- Tube d'encastrement et boîte de raccordement étanche à commander séparément.

GL019		MATIÈRE	LED	T°	System Lumen	α	€
GL019BNBX27	NEW	NOIR	ALUMINIUM	1W (350mA) 2W (700mA)	2700K	80 Lm (350mA) 130 Lm (700mA)	12° 157,00 A
GL019BNBX30	NEW	NOIR	ALUMINIUM	1W (350mA) 2W (700mA)	3000K	90 Lm (350mA) 150 Lm (700mA)	12° 157,00 A
GL019BNBX40	NEW	NOIR	ALUMINIUM	1W (350mA) 2W (700mA)	4000K	100 Lm (350mA) 180 Lm (700mA)	12° 157,00 A
GL019BNBXBL	NEW	NOIR	ALUMINIUM	1W (350mA) 2W (700mA)	BLUE	15 Lm (350mA) 25 Lm (700mA)	12° 157,00 A
GL019S27	NEW	INOX 316	INOX 316	1W (350mA) 2W (700mA)	2700K	80 Lm (350mA) 130 Lm (700mA)	12° 113,00 A
GL019SWW	NEW	INOX 316	INOX 316	1W (350mA) 2W (700mA)	3000K	90 Lm (350mA) 150 Lm (700mA)	12° 113,00 A
GL019SNW	NEW	INOX 316	INOX 316	1W (350mA) 2W (700mA)	4000K	100 Lm (350mA) 180 Lm (700mA)	12° 113,00 A
GL019ANBX27	NEW	LAITON ANTIQUE	LAITON ANTIQUE	1W (350mA) 2W (700mA)	2700K	80 Lm (350mA) 130 Lm (700mA)	12° 216,90 A
GL019ANBX30	NEW	LAITON ANTIQUE	LAITON ANTIQUE	1W (350mA) 2W (700mA)	3000K	90 Lm (350mA) 150 Lm (700mA)	12° 216,90 A
GL019BWBX27	NEW	NOIR	ALUMINIUM	1W (350mA) 2W (700mA)	2700K	80 Lm (350mA) 130 Lm (700mA)	38° 157,00 A
GL019BWBX30	NEW	NOIR	ALUMINIUM	1W (350mA) 2W (700mA)	3000K	90 Lm (350mA) 150 Lm (700mA)	38° 157,00 A
GL019BWBX40	NEW	NOIR	ALUMINIUM	1W (350mA) 2W (700mA)	4000K	100 Lm (350mA) 180 Lm (700mA)	38° 157,00 A
GL019BWBXBL	NEW	NOIR	ALUMINIUM	1W (350mA) 2W (700mA)	BLUE	15 Lm (350mA) 25 Lm (700mA)	38° 157,00 A
GL019F27	NEW	INOX 316	INOX 316	1W (350mA) 2W (700mA)	2700K	80 Lm (350mA) 130 Lm (700mA)	38° 113,00 A
GL019FWW	NEW	INOX 316	INOX 316	1W (350mA) 2W (700mA)	3000K	90 Lm (350mA) 150 Lm (700mA)	38° 113,00 A
GL019FNW	NEW	INOX 316	INOX 316	1W (350mA) 2W (700mA)	4000K	100 Lm (350mA) 180 Lm (700mA)	38° 113,00 A
GL019FBLUE	NEW	INOX 316	INOX 316	1W (350mA) 2W (700mA)	BLUE	15 Lm (350mA) 25 Lm (700mA)	38° 113,00 A
GL019FRED	NEW	INOX 316	INOX 316	1W (350mA) 2W (700mA)	RED	35 Lm (350mA)	38° 113,00 A
GL019FAMBER	NEW	INOX 316	INOX 316	1W (350mA) 2W (700mA)	AMBER	20 Lm (350mA)	38° 113,00 A
GL019AWBX27	NEW	LAITON ANTIQUE	LAITON ANTIQUE	1W (350mA) 2W (700mA)	2700K	80 Lm (350mA) 130 Lm (700mA)	38° 216,90 A
GL019AWBX30	NEW	LAITON ANTIQUE	LAITON ANTIQUE	1W (350mA) 2W (700mA)	3000K	90 Lm (350mA) 150 Lm (700mA)	38° 216,90 A

ACCESSOIRES		MATIÈRE	DESCRIPTION	L (mm)		€
TUBE332	NEW	ALUMINIUM	TUBE D'ENCASTREMENT 37x150mm	150		43,90 A
PSIP3509W	NEW		DRIVER 1-9W 350mA CC IP65	149		44,00 A
PSIP35018W	NEW		DRIVER 9-18W 350mA CC IP65	149		57,70 A
PSIP70018W	NEW		DRIVER 2-18W 700mA CC IP65	149		56,10 A
PSIP70036W	NEW		DRIVER 18-36W 700mA CC IP65	162		73,40 A
JB2	NEW		BOITE DE RACCORDEMENT SERIE 3 SORTIES IP68			13,60 A
JB4	NEW		BOITE DE CONNEXION SERIE AVEC GEL IP68			54,70 A
JB6	NEW		CONNECTEUR AVEC GEL IP68			29,60 A

## GL019 ULG



- Encastré de sol rond. Très basse luminance.
- Inox 316 pour les zones côtières.
- 1m de câble H05RN-F fourni (diamètre 6mm).
- Convertisseur 350mA à commander séparément.
- Tube d'encastrement et boîte de raccordement étanche à commander séparément.

GL019 ULG	MATIÈRE	LED	T°	LED Lumen	System Lumen	α	€
GL019DNBL27	NEW INOX 316	1W	2700K	80 Lm	70 Lm	12°	157,00 A
GL019DNBL30	NEW INOX 316	1W	3000K	90 Lm	74 Lm	12°	157,00 A
GL019DMBL27	NEW INOX 316	1W	2700K	80 Lm	60 Lm	30°	157,00 A
GL019DMBL30	NEW INOX 316	1W	3000K	90 Lm	64 Lm	30°	157,00 A

ACCESSOIRES	MATIÈRE	DESCRIPTION	L (mm)	€
TUBE332	NEW ALUMINIUM	TUBE D'ENCASTREMENT 37x150mm	150	43,90 A
PSIP3509W	NEW	DRIVER 1-9W 350mA CC IP65	149	44,00 A
PSIP35018W	NEW	DRIVER 9-18W 350mA CC IP65	149	57,70 A
JB2	NEW	BOITE DE RACCORDEMENT SERIE 3 SORTIES IP68		13,60 A
JB4	NEW	BOITE DE CONNEXION SERIE AVEC GEL IP68		54,70 A
JB6	NEW	CONNECTEUR AVEC GEL IP68		29,60 A

## GL019 LG

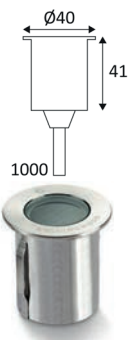

- Encastré de sol rond. Basse luminance, avec grille nid d'abeille.
- Inox 316 pour les zones côtières.
- 1m de câble H05RN-F fourni (diamètre 6mm).
- Convertisseur 350mA à commander séparément.
- Tube d'encastrement et boîte de raccordement étanche à commander séparément.

GL019 LG	MATIÈRE	LED	T°	LED Lumen	System Lumen	α	€
GL019LGS27	NEW INOX 316	1W	2700K	80 Lm	53 Lm	12°	116,50 A
GL019LGSWW	NEW INOX 316	1W	3000K	90 Lm	55 Lm	12°	116,50 A
GL019LGF27	NEW INOX 316	1W	2700K	80 Lm	53 Lm	30°	116,50 A
GL019LGFWW	NEW INOX 316	1W	3000K	90 Lm	55 Lm	30°	116,50 A
GL019LGFNW	NEW INOX 316	1W	4000K	90 Lm	65 Lm	30°	116,50 A

ACCESSOIRES	MATIÈRE	DESCRIPTION	L (mm)	€
TUBE332	NEW ALUMINIUM	TUBE D'ENCASTREMENT 37x150mm	150	43,90 A
PSIP3509W	NEW	DRIVER 1-9W 350mA CC IP65	149	44,00 A
PSIP35018W	NEW	DRIVER 9-18W 350mA CC IP65	149	57,70 A
JB2	NEW	BOITE DE RACCORDEMENT SERIE 3 SORTIES IP68		13,60 A
JB4	NEW	BOITE DE CONNEXION SERIE AVEC GEL IP68		54,70 A
JB6	NEW	CONNECTEUR AVEC GEL IP68		29,60 A



## GL019 F

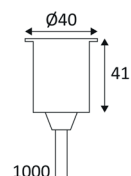
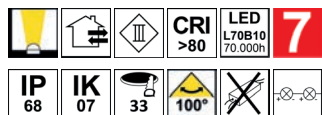

- Encastré de sol rond.
- Diffuseur en verre opalin.
- Versions inox 316 pour les zones côtières.
- 1m de câble H05RN-F fourni (diamètre 6mm).
- Convertisseur 350mA à commander séparément.
- Tube d'encastrement et boîte de raccordement étanche à commander séparément.

GL019 F		MATIÈRE	LED	T°	LED Lumen	System Lumen	€	
GL019BC0F27	NEW	NOIR	ALUMINIUM	1W	2700K	80 Lm	10 Lm	116,50 A
GL019BC0F30	NEW	NOIR	ALUMINIUM	1W	3000K	90 Lm	11 Lm	116,50 A
GL019BC0F40	NEW	NOIR	ALUMINIUM	1W	4000K	90 Lm	13 Lm	116,50 A
GL019DC0F27	NEW	INOX 316	INOX 316	1W	2700K	80 Lm	10 Lm	116,50 A
GL019DC0F30	NEW	INOX 316	INOX 316	1W	3000K	90 Lm	11 Lm	116,50 A
GL019DC0F40	NEW	INOX 316	INOX 316	1W	4000K	90 Lm	13 Lm	116,50 A
GL019DC0FBL	NEW	INOX 316	INOX 316	1W	BLUE		2 Lm	116,50 A

ACCESSOIRES		MATIÈRE	DESCRIPTION	L (mm)		€
TUBE332	NEW	ALUMINIUM	TUBE D'ENCASTREMENT 37x150mm	150		43,90 A
PSIP3509W	NEW		DRIVER 1-9W 350mA CC IP65	149		44,00 A
PSIP35018W	NEW		DRIVER 9-18W 350mA CC IP65	149		57,70 A
JB2	NEW		BOITE DE RACCORDEMENT SERIE 3 SORTIES IP68			13,60 A
JB4	NEW		BOITE DE CONNEXION SERIE AVEC GEL IP68			54,70 A
JB6	NEW		CONNECTEUR AVEC GEL IP68			29,60 A



NOIR



INOX 316



## GL019 SQ

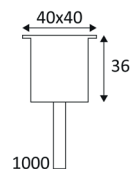

- Encastré de sol carré.
- Diffuseur en verre clair.
- Inox 316 pour les zones côtières.
- 1m de câble H05RN-F fourni (diamètre 6mm).
- Convertisseur 350mA ou 700mA à commander séparément.
- Tube d'encastrement et boîte de raccordement étanche à commander séparément.

GL019 SQ	MATIÈRE	LED	T°	System Lumen	€
GL019SQFWW	<b>NEW</b> INOX 316	1W (350mA) 2W (700mA)	3000K	80 Lm (350mA) 125 Lm (700mA)	124,00 A
GL019SQFNW	<b>NEW</b> INOX 316	1W (350mA) 2W (700mA)	4000K	90 Lm (350mA) 130 Lm (700mA)	124,00 A

ACCESSOIRES	MATIÈRE	DESCRIPTION	L (mm)	€
TUBE332	<b>NEW</b> ALUMINIUM	TUBE D'ENCASTREMENT 37x150mm	150	43,90 A
PSIP3509W	<b>NEW</b>	DRIVER 1-9W 350mA CC IP65	149	44,00 A
PSIP35018W	<b>NEW</b>	DRIVER 9-18W 350mA CC IP65	149	57,70 A
PSIP70018W	<b>NEW</b>	DRIVER 2-18W 700mA CC IP65	149	56,10 A
PSIP70036W	<b>NEW</b>	DRIVER 18-36W 700mA CC IP65	162	73,40 A
JB2	<b>NEW</b>	BOITE DE RACCORDEMENT SERIE 3 SORTIES IP68		13,60 A
JB4	<b>NEW</b>	BOITE DE CONNEXION SERIE AVEC GEL IP68		54,70 A
JB6	<b>NEW</b>	CONNECTEUR AVEC GEL IP68		29,60 A





## GL016

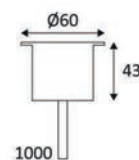
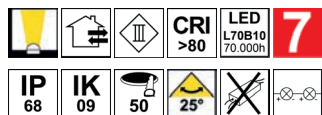

- Encastré de sol rond.
- Diffuseur en verre clair.
- Versions inox 316 pour les zones côtières.
- 1m de câble H05RN-F fourni (diamètre 6mm).
- Convertisseur 350mA ou 700mA à commander séparément.
- Tube d'encastrement et boîte de raccordement étanche à commander séparément.

GL016		MATIÈRE	LED	T°	System Lumen	€	
GL016BMBX27	NEW	NOIR	ALUMINIUM	1W (350mA) 2W (700mA)	2700K	70 Lm (350mA) 120 Lm (700mA)	136,00 A
GL016BMBX30	NEW	NOIR	ALUMINIUM	1W (350mA) 2W (700mA)	3000K	75 Lm (350mA) 135 Lm (700mA)	128,00 A
GL016BMBX40	NEW	NOIR	ALUMINIUM	1W (350mA) 2W (700mA)	4000K	95 Lm (350mA) 140 Lm (700mA)	128,00 A
GL016BMBXB	NEW	NOIR	ALUMINIUM	1W (350mA) 2W (700mA)	BLUE	20 Lm (350mA) 20 Lm (700mA)	128,00 A
GL016F27	NEW	INOX 316	INOX 316	1W (350mA) 2W (700mA)	2700K	70 Lm (350mA) 120 Lm (700mA)	128,00 A
GL016FWW	NEW	INOX 316	INOX 316	1W (350mA) 2W (700mA)	3000K	75 Lm (350mA) 135 Lm (700mA)	128,00 A
GL016FNW	NEW	INOX 316	INOX 316	1W (350mA) 2W (700mA)	4000K	95 Lm (350mA) 140 Lm (700mA)	128,00 A
GL016FBLUE	NEW	INOX 316	INOX 316	1W (350mA) 2W (700mA)	BLUE	10 Lm (350mA) 20 Lm (700mA)	128,00 A
GL016FAB27	NEW	LAITON ANTIQUE	LAITON ANTIQUE	1W (350mA) 2W (700mA)	2700K	70 Lm (350mA) 120 Lm (700mA)	136,00 A
GL016FABWW	NEW	LAITON ANTIQUE	LAITON ANTIQUE	1W (350mA) 2W (700mA)	3000K	75 Lm (350mA) 135 Lm (700mA)	136,00 A
GL016FABNW	NEW	LAITON ANTIQUE	LAITON ANTIQUE	1W (350mA) 2W (700mA)	4000K	95 Lm (350mA) 140 Lm (700mA)	136,00 A

ACCESSOIRES		MATIÈRE	DESCRIPTION	L (mm)		€
TUBE50	NEW	ALUMINIUM	TUBE D'ENCASTREMENT 56x150mm	150		44,60 A
PSIP3509W	NEW		DRIVER 1-9W 350mA CC IP65	149		44,00 A
PSIP35018W	NEW		DRIVER 9-18W 350mA CC IP65	149		57,70 A
PSIP70018W	NEW		DRIVER 2-18W 700mA CC IP65	149		56,10 A
PSIP70036W	NEW		DRIVER 18-36W 700mA CC IP65	162		73,40 A
JB2	NEW		BOITE DE RACCORDEMENT SERIE 3 SORTIES IP68			13,60 A
JB4	NEW		BOITE DE CONNEXION SERIE AVEC GEL IP68			54,70 A
JB6	NEW		CONNECTEUR AVEC GEL IP68			29,60 A
WCR275BLACK	NEW		CABLE H05RN-F 2x0,75mm² 1m			8,80 A



NOIR

INOX 316





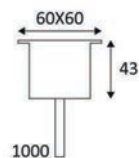
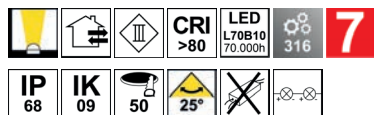



LAITON ANTIQUE

## GL016 SQ



- Encastré de sol carré.
- Diffuseur en verre clair.
- Inox 316 pour les zones côtières.
- 1m de câble H05RN-F fourni (diamètre 6mm).
- Convertisseur 350mA ou 700mA à commander séparément.
- Tube d'encastrement et boîte de raccordement étanche à commander séparément.

GL016 SQ	MATIÈRE	LED	T°	System Lumen	€
GL016SQ27	<b>NEW</b> INOX 316	1W (350mA) 2W (700mA)	2700K	70 Lm (350mA) 120 Lm (700mA)	156,00 A
GL016SQWW	<b>NEW</b> INOX 316	1W (350mA) 2W (700mA)	3000K	75 Lm (350mA) 135 Lm (700mA)	156,00 A
GL016SQNW	<b>NEW</b> INOX 316	1W (350mA) 2W (700mA)	4000K	95 Lm (350mA) 140 Lm (700mA)	156,00 A

ACCESSOIRES	MATIÈRE	DESCRIPTION	L (mm)	€
TUBE50	<b>NEW</b> ALUMINIUM	TUBE D'ENCASTREMENT 56x150mm	150	 44,60 A
PSIP3509W	<b>NEW</b>	DRIVER 1-9W 350mA CC IP65	149	 44,00 A
PSIP35018W	<b>NEW</b>	DRIVER 9-18W 350mA CC IP65	149	 57,70 A
PSIP70018W	<b>NEW</b>	DRIVER 2-18W 700mA CC IP65	149	 56,10 A
PSIP70036W	<b>NEW</b>	DRIVER 18-36W 700mA CC IP65	162	 73,40 A
JB2	<b>NEW</b>	BOITE DE RACCORDEMENT SERIE 3 SORTIES IP68		 13,60 A
JB4	<b>NEW</b>	BOITE DE CONNEXION SERIE AVEC GEL IP68		 54,70 A
JB6	<b>NEW</b>	CONNECTEUR AVEC GEL IP68		 29,60 A
WCR275BLACK	<b>NEW</b>	CABLE H05RN-F 2x0,75mm <sup>2</sup> 1m		 8,80 A





## GL016 F

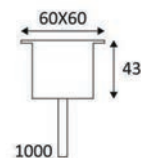
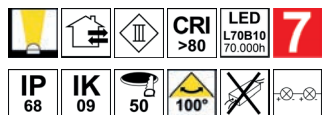

- Encastré de sol rond.
- Diffuseur en verre opalin.
- Versions inox 316 pour les zones côtières.
- 1m de câble H05RN-F fourni (diamètre 6mm).
- Convertisseur 350mA à commander séparément.
- Tube d'encastrement et boîte de raccordement à commander séparément.

GL016 F	MATIÈRE	LED	T°	LED Lumen	System Lumen	€
GL016BC0F27 <b>NEW</b>	NOIR ALUMINIUM	1W	2700K	80 Lm	12 Lm	136,00 A
GL016BC0F30 <b>NEW</b>	NOIR ALUMINIUM	1W	3000K	90 Lm	13 Lm	136,00 A
GL016BC0F40 <b>NEW</b>	NOIR ALUMINIUM	1W	4000K	90 Lm	15 Lm	136,00 A
GL016DC0F27 <b>NEW</b>	INOX 316	1W	2700K	80 Lm	12 Lm	136,00 A
GL016DC0F30 <b>NEW</b>	INOX 316	1W	3000K	90 Lm	13 Lm	136,00 A
GL016DC0F40 <b>NEW</b>	INOX 316	1W	4000K	90 Lm	15 Lm	136,00 A

ACCESSOIRES	MATIÈRE	DESCRIPTION	L (mm)	€
TUBE50 <b>NEW</b>	ALUMINIUM	TUBE D'ENCASTREMENT 56x150mm	150	44,60 A
PSIP3509W <b>NEW</b>		DRIVER 1-9W 350mA CC IP65	149	44,00 A
PSIP35018W <b>NEW</b>		DRIVER 9-18W 350mA CC IP65	149	57,70 A
JB2 <b>NEW</b>		BOITE DE RACCORDEMENT SERIE 3 SORTIES IP68		13,60 A
JB4 <b>NEW</b>		BOITE DE CONNEXION SERIE AVEC GEL IP68		54,70 A
JB6 <b>NEW</b>		CONNECTEUR AVEC GEL IP68		29,60 A
WCR275BLACK <b>NEW</b>		CABLE H05RN-F 2x0,75mm² 1m		8,80 A



NOIR

INOX 316



## GL063

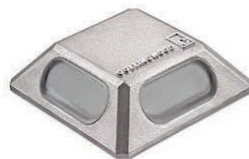
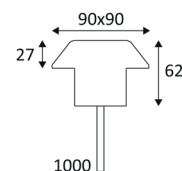
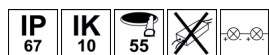
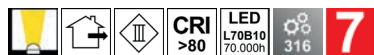

- Semi-encastré de sol carré pour balisage.
- Diffusion de la lumière dans trois directions.
- Inox 316 trempé pour les zones côtières.
- 1m de câble H05RN-F fourni (diamètre 6mm).
- Convertisseur 350mA à commander séparément.
- Tube d'encastrement et boîte de raccordement étanche à commander séparément.

GL063		MATIÈRE	LED	T°	LED Lumen	System Lumen	€	
GL063	<b>NEW</b>	INOX MOULÉ	INOX 316	3W	3000K	90 Lm	45 Lm	321,50 A
ACCESSOIRES		MATIÈRE	DESCRIPTION	L (mm)			€	
TUBE68	<b>NEW</b>	ALUMINIUM	TUBE D'ENCASTREMENT 72x150mm	150			48,00 A	
PSIP3509W	<b>NEW</b>		DRIVER 1-9W 350mA CC IP65	149			44,00 A	
PSIP35018W	<b>NEW</b>		DRIVER 9-18W 350mA CC IP65	149			57,70 A	
JB2	<b>NEW</b>		BOITE DE RACCORDEMENT SERIE 3 SORTIES IP68				13,60 A	
JB4	<b>NEW</b>		BOITE DE CONNEXION SERIE AVEC GEL IP68				54,70 A	
JB6	<b>NEW</b>		CONNECTEUR AVEC GEL IP68				29,60 A	
WCR275BLACK	<b>NEW</b>		CABLE H05RN-F 2x0,75mm² 1m				8,80 A	





## GL064

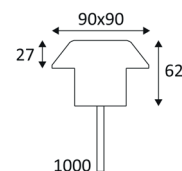
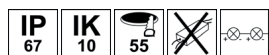
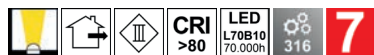

- Semi-encastré de sol carré pour balisage.
- Diffusion de la lumière dans quatre directions.
- Inox 316 trempé pour les zones côtières.
- 1m de câble H05RN-F fourni (diamètre 6mm).
- Convertisseur 350mA à commander séparément.
- Tube d'encastrement et boîte de raccordement étanche à commander séparément.

GL064		MATIÈRE	LED	T°	LED Lumen	System Lumen	€	
GL064	<b>NEW</b>	INOX MOULÉ	INOX 316	4W	3000K	90 Lm	65 Lm	333,60 A

ACCESSOIRES		MATIÈRE	DESCRIPTION	L (mm)		€
TUBE68	<b>NEW</b>	ALUMINIUM	TUBE D'ENCASTREMENT 72x150mm	150		48,00 A
PSIP3509W	<b>NEW</b>		DRIVER 1-9W 350mA CC IP65	149		44,00 A
PSIP35018W	<b>NEW</b>		DRIVER 9-18W 350mA CC IP65	149		57,70 A
JB2	<b>NEW</b>		BOITE DE RACCORDEMENT SERIE 3 SORTIES IP68			13,60 A
JB4	<b>NEW</b>		BOITE DE CONNEXION SERIE AVEC GEL IP68			54,70 A
JB6	<b>NEW</b>		CONNECTEUR AVEC GEL IP68			29,60 A
WCR275BLACK	<b>NEW</b>		CABLE H05RN-F 2x0,75mm² 1m			8,80 A

## GL100

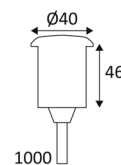
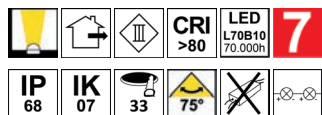

- Semi-encastré de sol rond pour balisage.
- Diffusion de la lumière dans une, deux, trois ou quatre directions.
- Versions inox 316 pour les zones côtières.
- 1m de câble H05RN-F fourni (diamètre 6mm).
- Immergeable jusqu'à 9m de profondeur.
- Convertisseur 350mA ou 700mA à commander séparément.
- Tube d'encastrement et boîte de raccordement étanche à commander séparément.

GL100	MATIÈRE	LED	T°	System Lumen	€
<b>1 FENETRE</b>					
GL100DX1X27	<b>NEW</b> INOX 316	1W (350mA) 2W (700mA)	2700K	2 Lm (350mA) 3 Lm (700mA)	180,00 A
GL100DX1X30	<b>NEW</b> INOX 316	1W (350mA) 2W (700mA)	3000K	2 Lm (350mA) 4 Lm (700mA)	180,00 A
GL100AX1X27	<b>NEW</b> LAITON ANTIQUE	1W (350mA) 2W (700mA)	2700K	2 Lm (350mA) 3 Lm (700mA)	199,00 A
GL100AX1X30	<b>NEW</b> LAITON ANTIQUE	1W (350mA) 2W (700mA)	3000K	2 Lm (350mA) 4 Lm (700mA)	199,00 A
<b>2 FENETRES / 1 DIRECTION</b>					
GL100DX2127	<b>NEW</b> INOX 316	1W (350mA) 2W (700mA)	2700K	4 Lm (350mA) 6 Lm (700mA)	180,00 A
GL100DX2130	<b>NEW</b> INOX 316	1W (350mA) 2W (700mA)	3000K	4 Lm (350mA) 8 Lm (700mA)	180,00 A
GL100DX2140	<b>NEW</b> INOX 316	1W (350mA) 2W (700mA)	4000K	6 Lm (350mA) 7 Lm (700mA)	180,00 A
GL100AX2127	<b>NEW</b> LAITON ANTIQUE	1W (350mA) 2W (700mA)	2700K	4 Lm (350mA) 6 Lm (700mA)	199,00 A
GL100AX2130	<b>NEW</b> LAITON ANTIQUE	1W (350mA) 2W (700mA)	3000K	4 Lm (350mA) 8 Lm (700mA)	199,00 A
<b>2 FENETRES / 2 DIRECTIONS</b>					
GL100DX2227	<b>NEW</b> INOX 316	1W (350mA) 2W (700mA)	2700K	4 Lm (350mA) 6 Lm (700mA)	180,00 A
GL100DX2230	<b>NEW</b> INOX 316	1W (350mA) 2W (700mA)	3000K	4 Lm (350mA) 8 Lm (700mA)	180,00 A
GL100DX2240	<b>NEW</b> INOX 316	1W (350mA) 2W (700mA)	4000K	6 Lm (350mA) 7 Lm (700mA)	180,00 A
GL100AX2227	<b>NEW</b> LAITON ANTIQUE	1W (350mA) 2W (700mA)	2700K	4 Lm (350mA) 6 Lm (700mA)	199,00 A
GL100AX2230	<b>NEW</b> LAITON ANTIQUE	1W (350mA) 2W (700mA)	3000K	4 Lm (350mA) 8 Lm (700mA)	199,00 A
<b>3 FENETRES</b>					
GL100DX3X27	<b>NEW</b> INOX 316	1W (350mA) 2W (700mA)	2700K	6 Lm (350mA) 9 Lm (700mA)	180,00 A
GL100DX3X30	<b>NEW</b> INOX 316	1W (350mA) 2W (700mA)	3000K	6 Lm (350mA) 12 Lm (700mA)	180,00 A
GL100AX3X27	<b>NEW</b> LAITON ANTIQUE	1W (350mA) 2W (700mA)	2700K	6 Lm (350mA) 9 Lm (700mA)	199,00 A
GL100AX3X30	<b>NEW</b> LAITON ANTIQUE	1W (350mA) 2W (700mA)	3000K	6 Lm (350mA) 12 Lm (700mA)	199,00 A
<b>4 FENETRES</b>					
GL100DX4X27	<b>NEW</b> INOX 316	1W (350mA) 2W (700mA)	2700K	8 Lm (350mA) 12 Lm (700mA)	180,00 A
GL100DX4X30	<b>NEW</b> INOX 316	1W (350mA) 2W (700mA)	3000K	8 Lm (350mA) 14 Lm (700mA)	180,00 A
GL100AX4X27	<b>NEW</b> LAITON ANTIQUE	1W (350mA) 2W (700mA)	2700K	8 Lm (350mA) 12 Lm (700mA)	199,00 A
GL100AX4X30	<b>NEW</b> LAITON ANTIQUE	1W (350mA) 2W (700mA)	3000K	8 Lm (350mA) 14 Lm (700mA)	199,00 A

ACCESSOIRES	MATIÈRE	DESCRIPTION	L (mm)	€
TUBE332	<b>NEW</b> ALUMINIUM	TUBE D'ENCASTREMENT 37x150mm	150	43,90 A
PSIP3509W	<b>NEW</b>	DRIVER 1-9W 350mA CC IP65	149	44,00 A
PSIP35018W	<b>NEW</b>	DRIVER 9-18W 350mA CC IP65	149	57,70 A
PSIP70018W	<b>NEW</b>	DRIVER 2-18W 700mA CC IP65	149	56,10 A
PSIP70036W	<b>NEW</b>	DRIVER 18-36W 700mA CC IP65	162	73,40 A
JB2	<b>NEW</b>	BOITE DE RACCORDEMENT SERIE 3 SORTIES IP68		13,60 A
JB4	<b>NEW</b>	BOITE DE CONNEXION SERIE AVEC GEL IP68		54,70 A
JB6	<b>NEW</b>	CONNECTEUR AVEC GEL IP68		29,60 A



## GL200

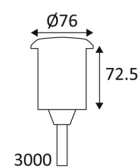
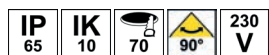

- Semi-encastré de sol rond pour balisage.
- Diffusion de la lumière dans une, deux, trois ou quatre directions.
- Versions inox 316 pour les zones côtières.
- 3m de câble H05RN-F fourni (diamètre 7mm).
- Convertisseur non dimmable intégré dans l'appareil.
- Tube d'encastrement et boîte de raccordement étanche à commander séparément.

GL200	MATIÈRE	LED	T°	LED Lumen	System Lumen	€
<b>1 FENETRE</b>						
GL200DX1X27	<b>NEW</b> INOX 316	5,7W	2700K	240 Lm	10 Lm	295,00 A
GL200DX1X30	<b>NEW</b> INOX 316	5,7W	3000K	270 Lm	10 Lm	295,00 A
GL200DX1X40	<b>NEW</b> INOX 316	5,7W	4000K	280 Lm	10 Lm	295,00 A
GL200AX1X30	<b>NEW</b> LAITON ANTIQUE	5,7W	3000K	270 Lm	10 Lm	569,00 A
<b>2 FENETRES / 1 DIRECTION</b>						
GL200DX2127	<b>NEW</b> INOX 316	5,7W	2700K	240 Lm	20 Lm	301,00 A
GL200DX2130	<b>NEW</b> INOX 316	5,7W	3000K	270 Lm	20 Lm	301,00 A
GL200DX2140	<b>NEW</b> INOX 316	5,7W	4000K	280 Lm	20 Lm	301,00 A
GL200AX2130	<b>NEW</b> LAITON ANTIQUE	5,7W	3000K	270 Lm	20 Lm	569,00 A
<b>2 FENETRES / 2 DIRECTIONS</b>						
GL200DX2227	<b>NEW</b> INOX 316	5,7W	2700K	240 Lm	20 Lm	301,00 A
GL200DX2230	<b>NEW</b> INOX 316	5,7W	3000K	270 Lm	20 Lm	301,00 A
GL200DX2240	<b>NEW</b> INOX 316	5,7W	4000K	280 Lm	20 Lm	301,00 A
GL200AX2230	<b>NEW</b> LAITON ANTIQUE	5,7W	3000K	270 Lm	20 Lm	569,00 A
<b>3 FENETRES</b>						
GL200DX3X27	<b>NEW</b> INOX 316	5,7W	2700K	240 Lm	30 Lm	308,00 A
GL200DX3X30	<b>NEW</b> INOX 316	5,7W	3000K	270 Lm	30 Lm	308,00 A
GL200AX3X30	<b>NEW</b> LAITON ANTIQUE	5,7W	3000K	270 Lm	30 Lm	569,00 A
<b>4 FENETRES</b>						
GL200DX4X27	<b>NEW</b> INOX 316	5,7W	2700K	240 Lm	40 Lm	315,00 A
GL200DX4X30	<b>NEW</b> INOX 316	5,7W	3000K	270 Lm	40 Lm	315,00 A
GL200DX4X40	<b>NEW</b> INOX 316	5,7W	4000K	280 Lm	40 Lm	315,00 A
GL200AX4X30	<b>NEW</b> LAITON ANTIQUE	5,7W	3000K	270 Lm	40 Lm	569,00 A

ACCESSOIRES	MATIÈRE	DESCRIPTION	L (mm)	€
TUBE68	<b>NEW</b> ALUMINIUM	TUBE D'ENCASTREMENT 72x150mm	150	48,00 A
JB5	<b>NEW</b>	BOITE DE CONNEXION PARALLELE AVEC GEL IP68		54,70 A
WC59	<b>NEW</b>	CONNECTEUR IP68		85,20 A



NEW

## GL050

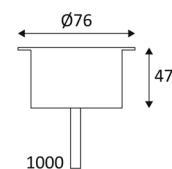

- Encastré de sol rond.
- Diffuseur en verre opalin.
- Inox 316 pour les zones côtières.
- 1m de câble H05RN-F fourni (diamètre 6mm).
- Convertisseur 350mA à commander séparément.
- Tube d'encastrement et boîte de raccordement étanche à commander séparément.

GL050	MATIÈRE	LED	T°	LED Lumen	System Lumen	€
GL05027	<b>NEW</b> INOX 316	3W	2700K	240 Lm	46 Lm	220,00 A
GL050WW	<b>NEW</b> INOX 316	3W	3000K	250 Lm	46 Lm	220,00 A
GL050NW	<b>NEW</b> INOX 316	3W	4000K	260 Lm	50 Lm	220,00 A
GL050BLUE	<b>NEW</b> INOX 316	3W	BLUE		7 Lm	220,00 A

ACCESSOIRES	MATIÈRE	DESCRIPTION	L (mm)	€
GLA01	<b>NEW</b> INOX 316	BAGUE CARREE 94x94mm	94	72,00 A
TUBE68	<b>NEW</b> ALUMINIUM	TUBE D'ENCASTREMENT 72x150mm	150	48,00 A
PSIP3509W	<b>NEW</b>	DRIVER 1-9W 350mA CC IP65	149	44,00 A
PSIP35018W	<b>NEW</b>	DRIVER 9-18W 350mA CC IP65	149	57,70 A
JB2	<b>NEW</b>	BOITE DE RACCORDEMENT SERIE 3 SORTIES IP68		13,60 A
JB4	<b>NEW</b>	BOITE DE CONNEXION SERIE AVEC GEL IP68		54,70 A
JB6	<b>NEW</b>	CONNECTEUR AVEC GEL IP68		29,60 A
WCR275BLACK	<b>NEW</b>	CABLE H05RN-F 2x0,75mm <sup>2</sup> 1m		8,80 A



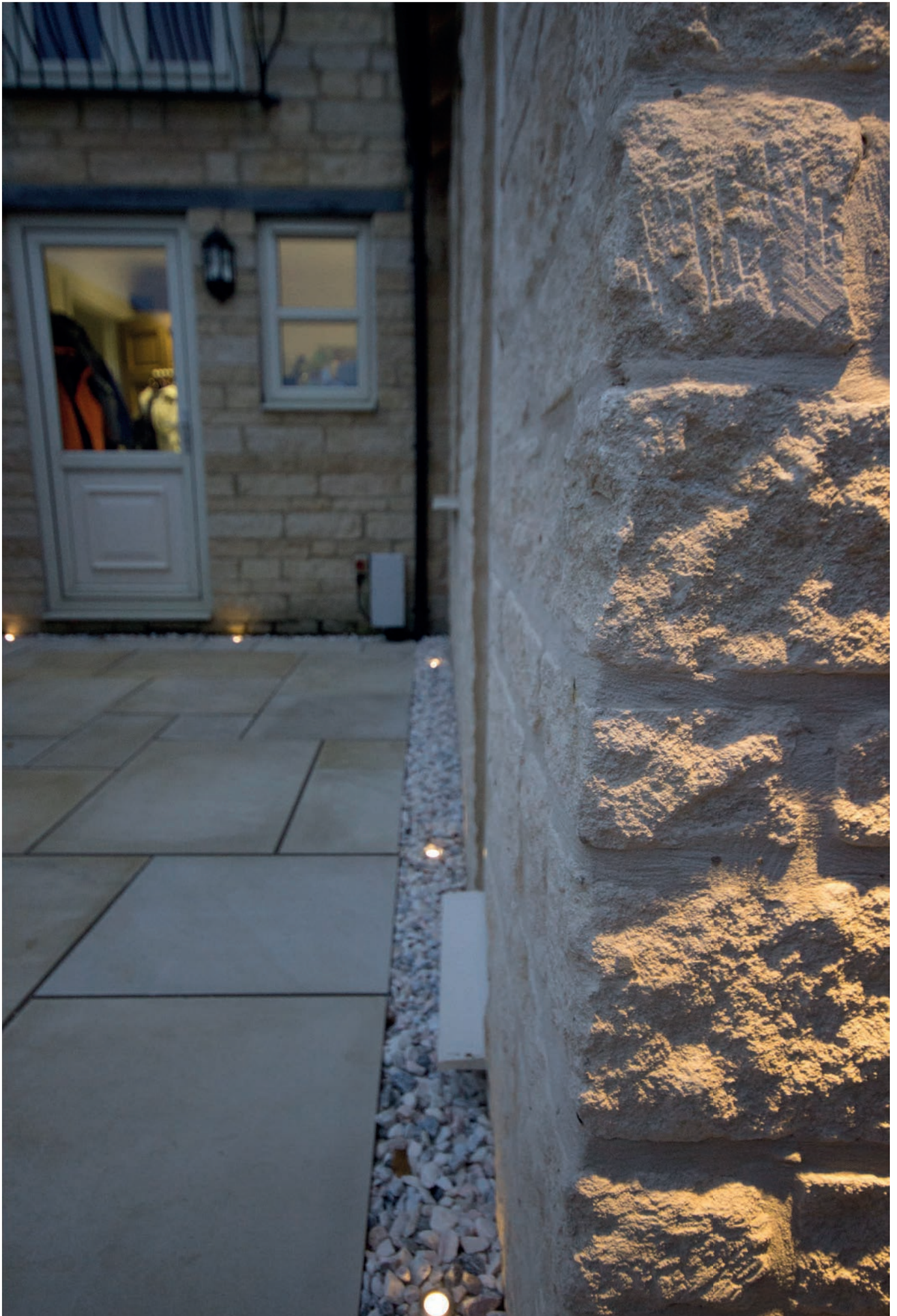

## GL018 C

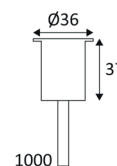

- Encastré de sol rond.
- Diffuseur en verre dépoli.
- 1m de câble H05RN-F fourni (diamètre 6mm).
- Immergeable jusqu'à 9m de profondeur.
- Convertisseur 24Vdc à commander séparément.
- Boîte de raccordement étanche à commander séparément.

GL018 C		MATIÈRE	LED	T°	LED Lumen	System Lumen	€
GL018C27	NEW	INOX 316	0,4W	2700K	20 Lm	4 Lm	84,00 A
GL018CWW	NEW	INOX 316	0,4W	3000K	30 Lm	4 Lm	84,00 A
GL018CNW	NEW	INOX 316	0,4W	4000K	30 Lm	4 Lm	84,00 A
GL018CBLUE	NEW	INOX 316	0,4W	BLUE		0,5 Lm	84,00 A
GL018CAB27	NEW	LAITON ANTIQUE	0,5W	2700K	20 Lm	3 Lm	101,70 A
GL018CABWW	NEW	LAITON ANTIQUE	0,4W	3000K	30 Lm	4 Lm	101,70 A
GL018CABNW	NEW	LAITON ANTIQUE	0,5W	4000K	30 Lm	3 Lm	101,70 A

ACCESSOIRES		DESCRIPTION	L (mm)		€
CD178	NEW	DRIVER 75W 24V CV IP67	155		72,30 A
CD179	NEW	DRIVER 100W 24V CV IP67	206		121,70 A
CD180	NEW	DRIVER 150W 24V CV IP67	206		125,10 A
CD181	NEW	DRIVER 250W 24V CV IP67	258		221,70 A
JB1	NEW	BOITE DE RACCORDEMENT PARALLELE 3 SORTIES IP68			13,60 A
JB5	NEW	BOITE DE CONNEXION PARALLELE AVEC GEL IP68			54,70 A
JB6	NEW	CONNECTEUR AVEC GEL IP68			29,60 A







## GL018 SQ

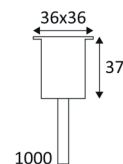
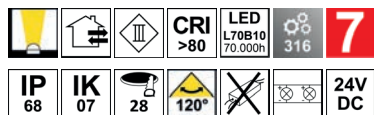

- Encastré de sol carré.
- Diffuseur en verre dépoli.
- 1m de câble H05RN-F fourni (diamètre 6mm).
- Immergeable jusqu'à 9m de profondeur.
- Convertisseur 24Vdc à commander séparément.
- Boîte de raccordement étanche à commander séparément.

GL018 SQ	MATIÈRE	LED	T°	LED Lumen	System Lumen	€
GL018SQWW <b>NEW</b>	INOX 316	0,5W	3000K	30 Lm	3 Lm	84,00 A

ACCESSOIRES	DESCRIPTION	L (mm)	€
CD178 <b>NEW</b>	DRIVER 75W 24V CV IP67	155	72,30 A
CD179 <b>NEW</b>	DRIVER 100W 24V CV IP67	206	121,70 A
CD180 <b>NEW</b>	DRIVER 150W 24V CV IP67	206	125,10 A
CD181 <b>NEW</b>	DRIVER 250W 24V CV IP67	258	221,70 A
JB1 <b>NEW</b>	BOITE DE RACCORDEMENT PARALLELE 3 SORTIES IP68		13,60 A
JB5 <b>NEW</b>	BOITE DE CONNEXION PARALLELE AVEC GEL IP68		54,70 A
JB6 <b>NEW</b>	CONNECTEUR AVEC GEL IP68		29,60 A





## GL008 RGBW

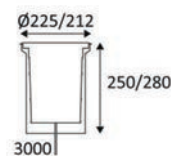

NEW

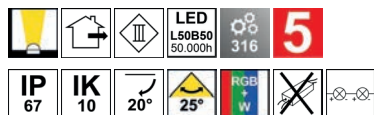

- Encastré de sol rond RGBW avec sources orientables.
- Diffuseur en verre clair.
- Carrossable résistance 2000kg (max 24km/h).
- Inox 316 pour les zones côtières.
- Pot d'encastrement et 3m de câble (diamètre 7,4mm) fournis.
- Convertisseur(s), contrôleur(s), répéteur(s) de puissance et accessoires à commander séparément (voir chapitre GESTION D'ECLAIRAGE).
- Un produit par répéteur de puissance PR3011.
- Connecteur étanche à commander séparément.

GL008 RGBW	MATIÈRE	LED	T°	System Lumen	€
GL008RGBW	<b>NEW</b> INOX 316	4x6,6W	RGB+W (4000K)	360 Lm (4000K)	1.205,00 A

ACCESSOIRES	DESCRIPTION	€
C100924	<b>NEW</b> CONTROLEUR LED RGB(W)	183,80 A
PR3011	<b>NEW</b> REPETEUR DE PUISSANCE RGB(W) 350mA 4x8,4W	108,20 A
JB7	<b>NEW</b> CONNECTEUR A VISSER 5 BORNES IP68	42,60 A



## GL090 RGBW

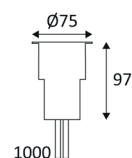
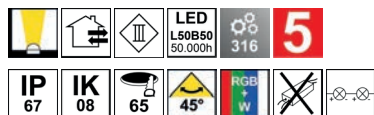

- Encastré de sol rond RGBW.
- Diffuseur en verre opalin.
- Inox 316 pour les zones côtières.
- Deux longueurs d'1m de câble (diamètre 7,4mm) fournies.
- Convertisseur(s), contrôleur(s), répéteur(s) de puissance et accessoires à commander séparément (voir chapitre GESTION D'ECLAIRAGE).
- Un à deux produit(s) par répéteur de puissance PR3011.
- Tube d'encastrement et connecteur étanche à commander séparément.

GL090 RGBW	MATIÈRE	LED	T°	System Lumen	€
GL090RGBW	<b>NEW</b> INOX 316	4x3W	RGB+W (4000K)	177 Lm (4000K)	530,00 A

ACCESSOIRES	MATIÈRE	DESCRIPTION	L (mm)	€
GLA01	<b>NEW</b> INOX 316	BAGUE CARREE 94x94mm	94	72,00 A
TUBE68	<b>NEW</b> ALUMINIUM	TUBE D'ENCASTREMENT 72x150mm	150	48,00 A
C100924	<b>NEW</b>	CONTROLEUR LED RGB(W)		183,80 A
PR3011	<b>NEW</b>	REPETEUR DE PUISSANCE RGB(W) 350mA 4x8,4W		108,20 A
JB7	<b>NEW</b>	CONNECTEUR A VISSER 5 BORNES IP68		42,60 A





## GL040 CA RGB

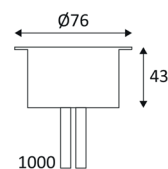
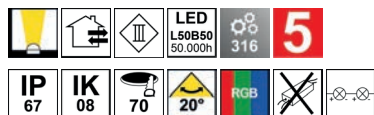

- Encastré de sol rond RGB.
- Diffuseur en verre clair.
- Inox 316 pour les zones côtières.
- Deux longueurs d'1m de câble (diamètre 6mm) fournies.
- Convertisseur(s), contrôleur(s), répéteur(s) de puissance et accessoires à commander séparément (voir chapitre GESTION D'ECLAIRAGE).
- Un à six produit(s) par répéteur de puissance PR3011.
- Tube d'encastrement et connecteur étanche à commander séparément.

GL040 CA RGB	MATIÈRE	LED	T°	System Lumen	€
GL040CARGB	<b>NEW</b> INOX 316	3x1,2W	RGB	8 - 253 Lm	292,40 A

ACCESSOIRES	MATIÈRE	DESCRIPTION	L (mm)	€
GLA01	<b>NEW</b> INOX 316	BAGUE CARREE 94x94mm	94	72,00 A
TUBE68	<b>NEW</b> ALUMINIUM	TUBE D'ENCASTREMENT 72x150mm	150	48,00 A
C100924	<b>NEW</b>	CONTROLEUR LED RGB(W)		183,80 A
PR3011	<b>NEW</b>	REPETEUR DE PUISSANCE RGB(W) 350mA 4x8,4W		108,20 A
JB7	<b>NEW</b>	CONNECTEUR A VISSER 5 BORNES IP68		42,60 A

## GL016 RGBW

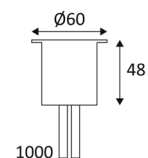
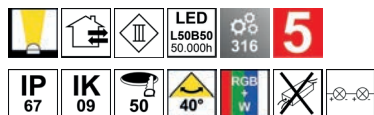

- Encastré de sol rond RGBW.
- Diffuseur en verre clair.
- Inox 316 pour les zones côtières.
- Deux longueurs d'1m de câble (diamètre 7,4mm) fournies.
- Convertisseur(s), contrôleur(s), répéteur(s) de puissance et accessoires à commander séparément (voir chapitre GESTION D'ECLAIRAGE).
- Un à six produit(s) par répéteur de puissance PR3011.
- Tube d'encastrement et connecteur étanche à commander séparément.

GL016 RGBW	MATIÈRE	LED	T°	System Lumen	€
GL016RGBW	<b>NEW</b> INOX 316	4x1,2W	RGB+W (4000K)	50 Lm (4000K)	285,00 A

ACCESSOIRES	MATIÈRE	DESCRIPTION	L (mm)	€
TUBE50	<b>NEW</b> ALUMINIUM	TUBE D'ENCASTREMENT 56x150mm	150	44,60 A
C100924	<b>NEW</b>	CONTROLEUR LED RGB(W)		183,80 A
PR3011	<b>NEW</b>	REPÉTEUR DE PUISSANCE RGB(W) 350mA 4x8,4W		108,20 A
JB7	<b>NEW</b>	CONNECTEUR A VISSER 5 BORNES IP68		42,60 A





## GL050 RGBW

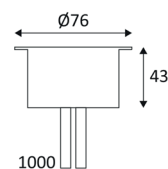
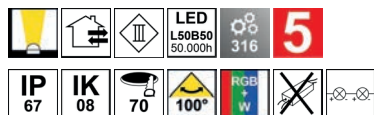

- Encastré de sol rond RGBW.
- Diffuseur en verre opalin.
- Inox 316 pour les zones côtières.
- Deux longueurs d'1m de câble (diamètre 7,4mm) fournies.
- Convertisseur(s), contrôleur(s), répéteur(s) de puissance et accessoires à commander séparément (voir chapitre GESTION D'ECLAIRAGE).
- Un à six produit(s) par répéteur de puissance PR3011.
- Tube d'encastrement et connecteur étanche à commander séparément.

GL050 RGBW	MATIÈRE	LED	T°	System Lumen	€
GL050RGBW	<b>NEW</b> INOX 316	4x1,2W	RGB+W (4000K)	11 Lm (4000K)	413,80 A

ACCESSOIRES	MATIÈRE	DESCRIPTION	L (mm)	€
GLA01	<b>NEW</b> INOX 316	BAGUE CARREE 94x94mm	94	72,00 A
TUBE68	<b>NEW</b> ALUMINIUM	TUBE D'ENCASTREMENT 72x150mm	150	48,00 A
C100924	<b>NEW</b>	CONTROLEUR LED RGB(W)		183,80 A
PR3011	<b>NEW</b>	REPETEUR DE PUISSANCE RGB(W) 350mA 4x8,4W		108,20 A
JB7	<b>NEW</b>	CONNECTEUR A VISSER 5 BORNES IP68		42,60 A



# INDIGO

LIGHTING

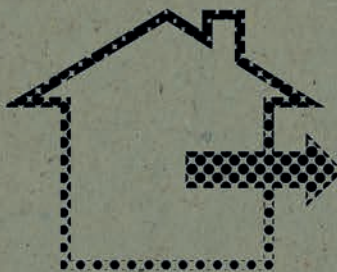





**SPOTS SUR PIQUETS**





## LUXI 65 GU10

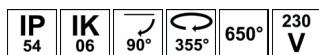

- Spot d'accentuation pour éclairage extérieur.
- Câble 2.00m et piquet à enterrer inclus.



LUXI 65 GU10	MATIÈRE	SOCKET	LAMP	Watt Max	€
OU10824	ANTHRACITE	FONTE D'ALUMINIUM	GU10	PAR16 LED	11W 65,90 B
ACCESSOIRES	DESCRIPTION				€
OU48405	CONNECTEUR 2PIN IP68		11,30	B	
OU48505	CONNECTEUR 3PIN IP68		30,90	B	

## TURA GU10

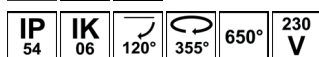

- Spot d'accentuation pour éclairage extérieur.
- Câble 2.00m et piquet à enterrer inclus.

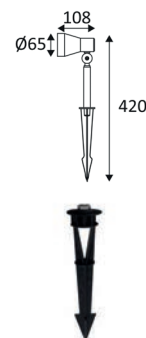

TURA GU10	MATIÈRE	SOCKET	LAMP	Watt Max	€
OU43624	ANTHRACITE	FONTE D'ALUMINIUM	GU10	PAR16 LED	11W 62,80 B
ACCESSOIRES	DESCRIPTION				€
OU48405	CONNECTEUR 2PIN IP68		11,30	B	
OU48505	CONNECTEUR 3PIN IP68		30,90	B	

## OLA 1

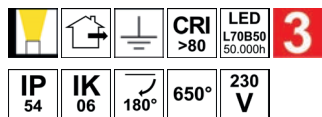

- Spot d'accentuation pour éclairage extérieur.
- Câble 0.30m et piquet à enterrer inclus.
- Convertisseur non dimmable intégré dans l'appareil.
- Accessoire inclus : plaque occultante amovible.

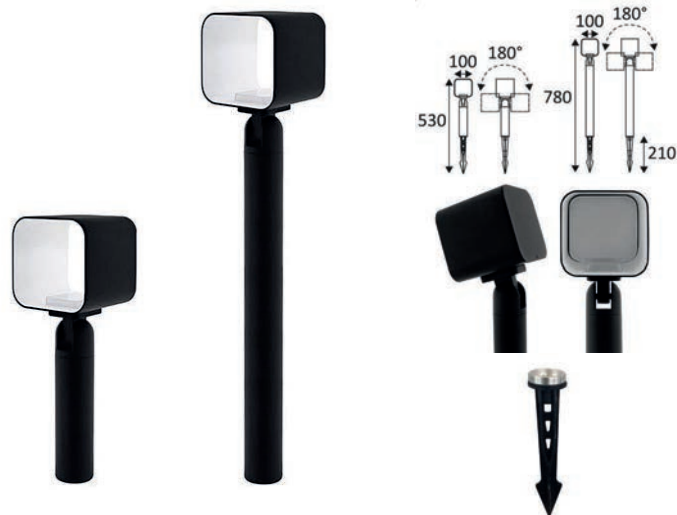

OLA 1		MATIÈRE	LED	T°	LED Lumen	System Lumen	L (mm)	€
OU482WW05	■ NOIR MAT	ALUMINIUM	3W	3000K	420 Lm	230 Lm	320	115,40 B
OU483WW05	■ NOIR MAT	ALUMINIUM	3W	3000K	420 Lm	230 Lm	570	122,60 B

ACCESSOIRES	DESCRIPTION	€
OU48405	CONNECTEUR 2PIN IP68	11,30 B
OU48505	CONNECTEUR 3PIN IP68	30,90 B



**OLA 2**  
DANS LA MÊME GAMME  
PAGE 473









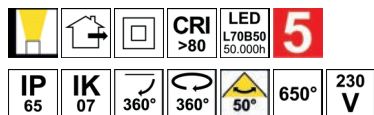

## BASIL 3 P

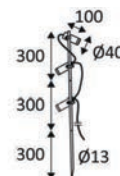

- Spot d'accentuation pour éclairage extérieur.
- Hauteur de tige réglable : 60 ou 90cm.
- Disposition des spots ajustable.
- Câble 2.50m et piquet à enterrer inclus.
- Convertisseurs non dimmables intégrés dans l'appareil.



NEW

BASIL 3 P		MATIÈRE	LED	T°	LED Lumen	System Lumen	€
OU519WW05	<b>NEW</b> NOIR MAT	ALUMINIUM	3x4W	3000K	3x475 Lm	3x295 Lm	277,10 A
ACCESSOIRES	DESCRIPTION						€
OU48405	CONNECTEUR 2PIN IP68			11,30	B		
OU48505	CONNECTEUR 3PIN IP68			30,90	B		









## RIESA

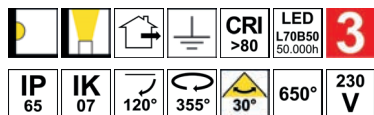

- Spot d'accentuation pour éclairage extérieur.
- Câble 1.50m et piquet à enterrer inclus.
- Convertisseur non dimmable intégré dans l'appareil.

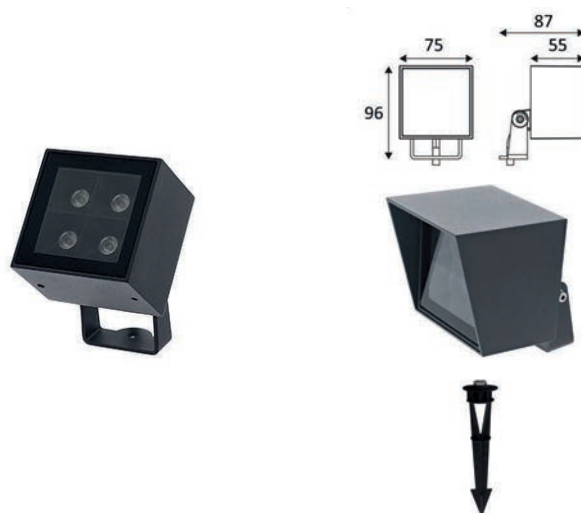

RIESA	MATIÈRE	LED	T°	LED Lumen	System Lumen	€
OU461WW24	ANTHRACITE	6W	3000K	550 Lm	398 Lm	114,30 B

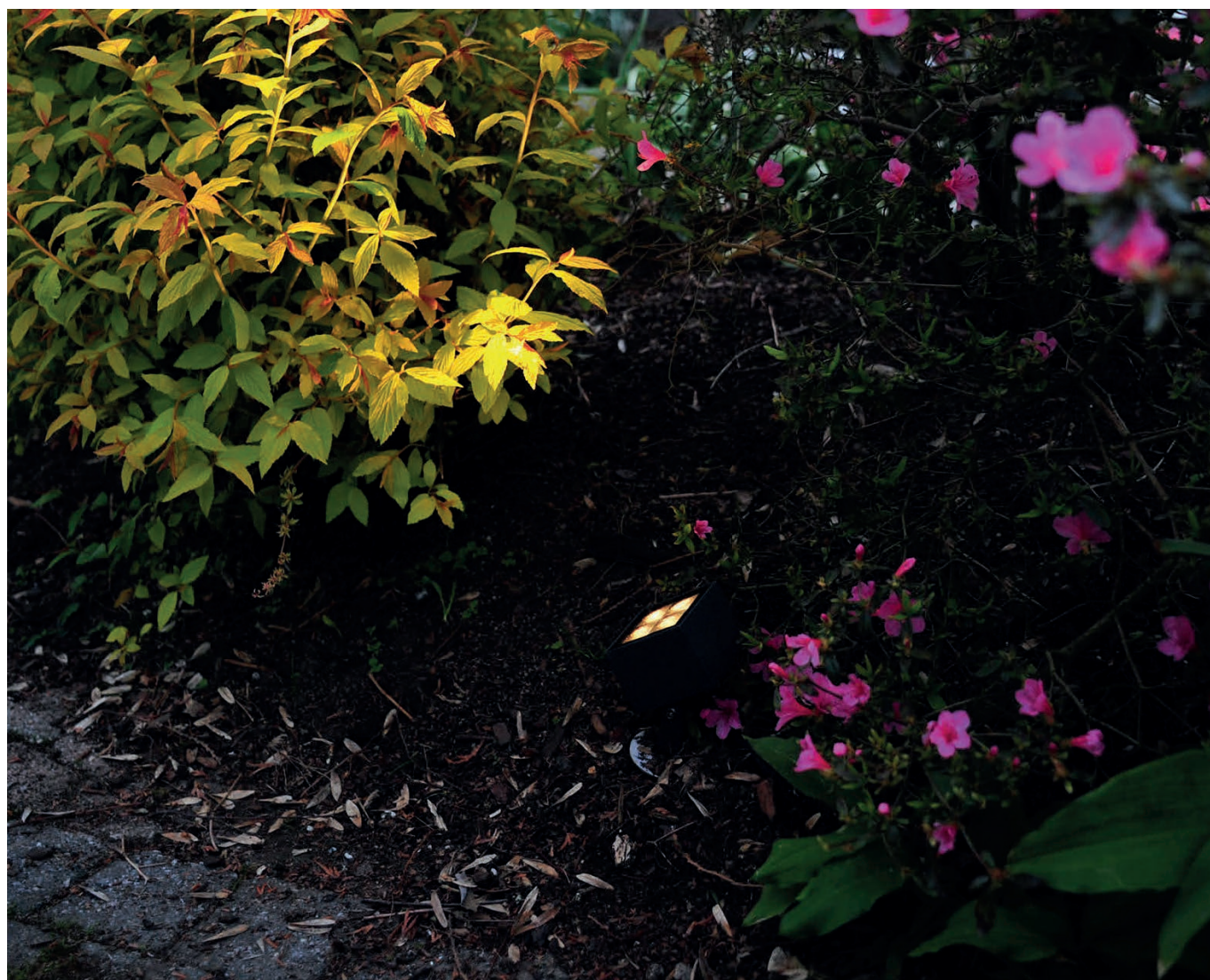

ACCESSOIRES	DESCRIPTION	€
OU46224	VISIERE	12,40 B
OU48405	CONNECTEUR 2PIN IP68	11,30 B
OU48505	CONNECTEUR 3PIN IP68	30,90 B

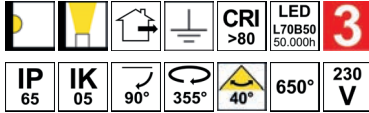

**BRAMA 1**

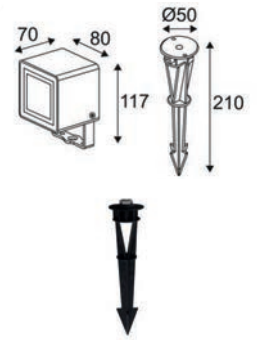
- Spot d'accentuation pour éclairage extérieur.
- Câble 1.50m et piquet à enterrer inclus.
- Double presse étoupe.
- Convertisseur non dimmable intégré dans l'appareil.



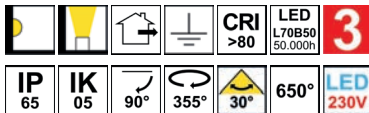

BRAMA 1	MATIÈRE	LED	T°	LED Lumen	System Lumen	€	
OU345WW24	ANTHRACITE	FONTE D'ALUMINIUM	7W	3000K	1000 Lm	596 Lm	153,50 B
ACCESSOIRES	DESCRIPTION	€					
OU48405	CONNECTEUR 2PIN IP68	 11,30 B					
OU48505	CONNECTEUR 3PIN IP68	 30,90 B					

**BRAMA 2**

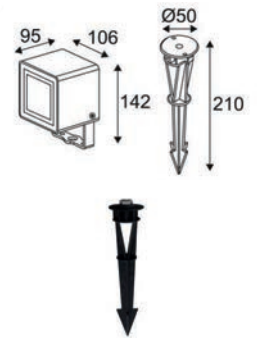
- Spot d'accentuation pour éclairage extérieur.
- Câble 1.50m et piquet à enterrer inclus.
- Double presse étoupe.
- Ne nécessite pas de convertisseur.
- Non dimmable.



BRAMA 2	MATIÈRE	LED	T°	LED Lumen	System Lumen	€	
OU346WW24	ANTHRACITE	FONTE D'ALUMINIUM	20W	3000K	1800 Lm	1563 Lm	206,00 B
ACCESSOIRES	DESCRIPTION	€					
OU48405	CONNECTEUR 2PIN IP68	 11,30 B					
OU48505	CONNECTEUR 3PIN IP68	 30,90 B					



## GUNZY

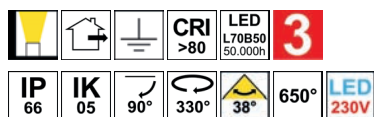

- Spot d'accentuation pour éclairage extérieur.
- Câble 2.00m et piquet à enterrer en acier inoxydable inclus.
- Ne nécessite pas de convertisseur.
- Non dimmable.

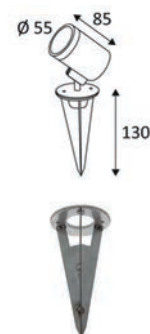

GUNZY	MATIÈRE	LED	T°	LED Lumen	System Lumen	€
OU458WW24	ANTHRACITE	FONTE D'ALUMINIUM	8W	3000K	760 Lm	463 Lm 173,00 B

ACCESSOIRES	DESCRIPTION	€
OU48405	CONNECTEUR 2PIN IP68	11,30 B
OU48505	CONNECTEUR 3PIN IP68	30,90 B

## GUNZY P

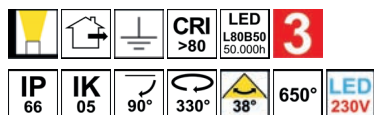

- Spot d'accentuation pour éclairage extérieur.
- Câble 2.50m et piquet à enterrer inclus.
- Ne nécessite pas de convertisseur.
- Non dimmable.

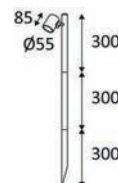

GUNZY P	MATIÈRE	LED	T°	LED Lumen	System Lumen	€
OU18724	ANTHRACITE	FONTE D'ALUMINIUM	8W	3000K	760 Lm	463 Lm 218,40 B

ACCESSOIRES	DESCRIPTION	€
OU48405	CONNECTEUR 2PIN IP68	11,30 B
OU48505	CONNECTEUR 3PIN IP68	30,90 B



**GUNZY S**  
DANS LA MÊME GAMME  
PAGE 524



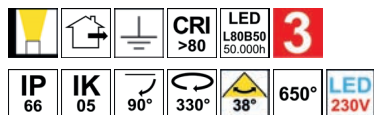

## GUNZY 2 P

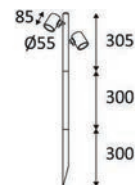

- Spot d'accentuation pour éclairage extérieur.
- Câble 2.50m et piquet à enterrer inclus.
- Ne nécessite pas de convertisseur.
- Non dimmable.



GUNZY 2 P	MATIÈRE	LED	T°	LED Lumen	System Lumen	€	
OU457WW24	ANTHRACITE	FONTE D'ALUMINIUM	2x8W	3000K	2x760 Lm	2x463 Lm	299,70 B
ACCESSOIRES	DESCRIPTION		€				
OU48405	CONNECTEUR 2PIN IP68		11,30 B		<b>GUNZY 2 S</b> DANS LA MÊME GAMME PAGE 524		
OU48505	CONNECTEUR 3PIN IP68		30,90 B				



## YUKA

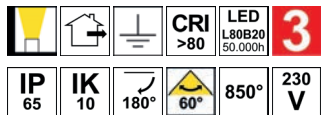

- Spot d'accentuation pour éclairage extérieur.
- Câble 0.60m, boîtier de connexion et piquet à enterrer inclus.
- Convertisseur non dimmable intégré dans l'appareil.



YUKA	MATIÈRE	LED	T°	LED Lumen	System Lumen	€	
OU497WW05	NOIR MAT	ALUMINIUM	8W	3000K	1100 Lm	835 Lm	92,70 B





## ANDY

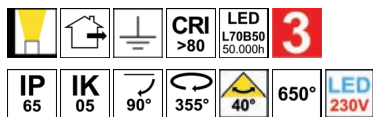

- Spot d'accentuation pour éclairage extérieur.
- Câble 1.50m, boîtier de connexion et piquet à enterrer inclus.
- Ne nécessite pas de convertisseur.
- Non dimmable.



ANDY		MATIÈRE	LED	T°	LED Lumen	System Lumen	L (mm)	€
OU465WW24	■ ANTHRACITE	FRONTE D'ALUMINIUM	15W	3000K	1490 Lm	985 Lm	210	158,60 B
OU466WW24	■ ANTHRACITE	FRONTE D'ALUMINIUM	15W	3000K	1490 Lm	985 Lm	520	172,00 B









## SL030

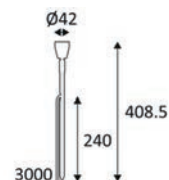

NEW

- Spot d'accentuation pour éclairage extérieur.
- Versions inox 316 pour les zones côtières.
- Câble H05RN-F 3.00m (diamètre 6mm) et piquet à enterrer inclus.
- Convertisseur 350mA ou 700mA à commander séparément.
- Boîte de raccordement étanche à commander séparément.

SL030		MATIÈRE	LED	T°	System Lumen	€	
SL13027	<b>NEW</b>	NOIR	ALUMINIUM	1W (350mA) 2W (700mA)	2700K	70 Lm (350mA) 120 Lm (700mA)	179,00 A
SL13030	<b>NEW</b>	NOIR	ALUMINIUM	1W (350mA) 2W (700mA)	3000K	75 Lm (350mA) 135 Lm (700mA)	179,00 A
SL030F27	<b>NEW</b>	INOX 316	INOX 316	1W (350mA) 2W (700mA)	2700K	70 Lm (350mA) 120 Lm (700mA)	179,00 A
SL030FWW	<b>NEW</b>	INOX 316	INOX 316	1W (350mA) 2W (700mA)	3000K	75 Lm (350mA) 135 Lm (700mA)	179,00 A
SL030FNW	<b>NEW</b>	INOX 316	INOX 316	1W (350mA) 2W (700mA)	4000K	95 Lm (350mA) 140 Lm (700mA)	179,00 A
SL130ZMBX27	<b>NEW</b>	BRONZE	ALUMINIUM	1W (350mA) 2W (700mA)	2700K	70 Lm (350mA) 120 Lm (700mA)	179,00 A
SL130ZMBX30	<b>NEW</b>	BRONZE	ALUMINIUM	1W (350mA) 2W (700mA)	3000K	75 Lm (350mA) 135 Lm (700mA)	179,00 A

ACCESSOIRES		DESCRIPTION	L (mm)		€
PSIP3509W	<b>NEW</b>	DRIVER 1-9W 350mA CC IP65	149		44,00 A
PSIP35018W	<b>NEW</b>	DRIVER 9-18W 350mA CC IP65	149		57,70 A
PSIP70018W	<b>NEW</b>	DRIVER 2-18W 700mA CC IP65	149		56,10 A
PSIP70036W	<b>NEW</b>	DRIVER 18-36W 700mA CC IP65	162		73,40 A
JB2	<b>NEW</b>	BOITE DE RACCORDEMENT SERIE 3 SORTIES IP68			13,60 A
JB4	<b>NEW</b>	BOITE DE CONNEXION SERIE AVEC GEL IP68			54,70 A
JB6	<b>NEW</b>	CONNECTEUR AVEC GEL IP68			29,60 A
WCR275BLACK	<b>NEW</b>	CABLE H05RN-F 2x0,75mm² 1m			8,80 A



NOIR



INOX 316



BRONZE



## SL220

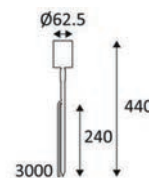
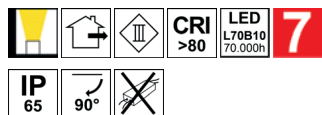

- Spot d'accentuation pour éclairage extérieur.
- Versions inox 316 pour les zones côtières.
- Câble H05RN-F 3.00m (diamètre 6mm) et piquet à enterrer inclus.
- Convertisseur 350mA ou 700mA à commander séparément.
- Boîte de raccordement étanche à commander séparément.

SL220			MATIÈRE	LED	T°	System Lumen	α	€
SL220BNBX27	NEW	NOIR	ALUMINIUM	2,2W (350mA) 4,6W (700mA)	2700K	310 Lm (350mA) 530 Lm (700mA)	12°	225,00 A
SL220BNBX30	NEW	NOIR	ALUMINIUM	2,2W (350mA) 4,6W (700mA)	3000K	310 Lm (350mA) 530 Lm (700mA)	12°	225,00 A
SL220BWBX27	NEW	NOIR	ALUMINIUM	2,2W (350mA) 4,6W (700mA)	2700K	290 Lm (350mA) 515 Lm (700mA)	40°	225,00 A
SL220BWBX30	NEW	NOIR	ALUMINIUM	2,2W (350mA) 4,6W (700mA)	3000K	300 Lm (350mA) 520 Lm (700mA)	40°	225,00 A
SL220DWBX27	NEW	INOX 316	INOX 316	2,2W (350mA) 4,6W (700mA)	2700K	290 Lm (350mA) 515 Lm (700mA)	40°	270,00 A
SL220DWBX30	NEW	INOX 316	INOX 316	2,2W (350mA) 4,6W (700mA)	3000K	300 Lm (350mA) 520 Lm (700mA)	40°	270,00 A
SL220ZWBX27	NEW	BRONZE	ALUMINIUM	2,2W (350mA) 4,6W (700mA)	2700K	290 Lm (350mA) 515 Lm (700mA)	40°	225,00 A
SL220ZWBX30	NEW	BRONZE	ALUMINIUM	2,2W (350mA) 4,6W (700mA)	3000K	300 Lm (350mA) 520 Lm (700mA)	40°	225,00 A
SL220CWBX27	NEW	CUIVRE	CUIVRE	2,2W (350mA) 4,6W (700mA)	2700K	290 Lm (350mA) 515 Lm (700mA)	40°	559,00 A

ACCESSOIRES			MATIÈRE	DESCRIPTION	L (mm)	€
GH220B	NEW	NOIR	ALUMINIUM	CYLINDRE ASYMETRIQUE		59,60 A
GH220D	NEW	INOX 316	INOX 316	CYLINDRE ASYMETRIQUE		91,80 A
GH220Z	NEW	BRONZE	ALUMINIUM	CYLINDRE ASYMETRIQUE		59,60 A
GS220B	NEW	NOIR	ALUMINIUM	CYLINDRE BASSE LUMINANCE		59,60 A
GS220D	NEW	INOX 316	INOX 316	CYLINDRE BASSE LUMINANCE		91,80 A
GS220Z	NEW	BRONZE	ALUMINIUM	CYLINDRE BASSE LUMINANCE		59,60 A
PSIP3509W	NEW			DRIVER 1-9W 350mA CC IP65	149	44,00 A
PSIP35018W	NEW			DRIVER 9-18W 350mA CC IP65	149	57,70 A
PSIP70018W	NEW			DRIVER 2-18W 700mA CC IP65	149	56,10 A
PSIP70036W	NEW			DRIVER 18-36W 700mA CC IP65	162	73,40 A
JB2	NEW			BOITE DE RACCORDEMENT SERIE 3		13,60 A
JB4	NEW			BOITE DE CONNEXION SERIE AVEC GEL IP68		54,70 A
JB6	NEW			CONNECTEUR AVEC GEL IP68		29,60 A



NOIR



INOX 316



BRONZE





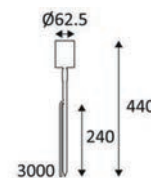



CUIVRE

**SL220 MAINS**

- Spot d'accentuation pour éclairage extérieur.
- Versions inox 316 pour les zones côtières.
- Câble H05RN-F 3.00m (diamètre 7mm) et piquet à enterrer inclus.
- Convertisseur non dimmable intégré dans l'appareil.
- Boîte de connexion étanche à commander séparément.

SL220 MAINS		MATIÈRE	LED	T°	System Lumen	€
SL220BWBM27	<b>NEW</b>	NOIR	ALUMINIUM	5,7W	2700K	515 Lm 289,00 A
SL220BWBM30	<b>NEW</b>	NOIR	ALUMINIUM	5,7W	3000K	520 Lm 289,00 A
SL220DWBM27	<b>NEW</b>	INOX 316	INOX 316	5,7W	2700K	515 Lm 323,00 A
SL220DWBM30	<b>NEW</b>	INOX 316	INOX 316	5,7W	3000K	520 Lm 323,00 A
SL220ZWBM27	<b>NEW</b>	BRONZE	ALUMINIUM	5,7W	2700K	515 Lm 289,00 A
SL220ZWBM30	<b>NEW</b>	BRONZE	ALUMINIUM	5,7W	3000K	520 Lm 289,00 A
SL220CWBM27	<b>NEW</b>	CUIVRE	CUIVRE	5,7W	2700K	515 Lm 628,00 A

ACCESSOIRES		MATIÈRE	DESCRIPTION	€	
GH220B	<b>NEW</b>	NOIR	ALUMINIUM	CYLINDRE ASYMETRIQUE	 59,60 A
GH220D	<b>NEW</b>	INOX 316	INOX 316	CYLINDRE ASYMETRIQUE	 91,80 A
GH220Z	<b>NEW</b>	BRONZE	ALUMINIUM	CYLINDRE ASYMETRIQUE	 59,60 A
GS220B	<b>NEW</b>	NOIR	ALUMINIUM	CYLINDRE BASSE LUMINANCE	 59,60 A
GS220D	<b>NEW</b>	INOX 316	INOX 316	CYLINDRE BASSE LUMINANCE	 91,80 A
GS220Z	<b>NEW</b>	BRONZE	ALUMINIUM	CYLINDRE BASSE LUMINANCE	 59,60 A
JB5	<b>NEW</b>			BOITE DE CONNEXION PARALLELE AVEC GEL IP68	 54,70 A

**WL220 MAINS**DANS LA MÊME GAMME  
PAGE 522

NOIR



INOX 316



BRONZE



CUIVRE

## SL230

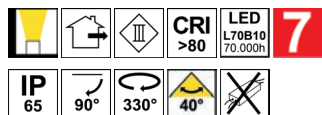
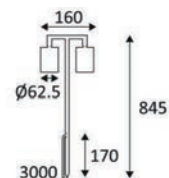
- Spot d'accentuation pour éclairage extérieur.
- Versions inox 316 pour les zones côtières.
- Câble H05RN-F 3.00m (diamètre 6mm) et piquet à enterrer inclus.
- Convertisseur 350mA ou 700mA à commander séparément.
- Boîte de raccordement étanche à commander séparément.

SL230		MATIÈRE	LED	T°	System Lumen	€	
SL230BWBX27	<b>NEW</b>	NOIR	ALUMINIUM	4,4W (350mA) 9,2W (700mA)	2700K	580 Lm (350mA) 1030 Lm (700mA)	467,00 A
SL230BWBX30	<b>NEW</b>	NOIR	ALUMINIUM	4,4W (350mA) 9,2W (700mA)	3000K	580 Lm (350mA) 1030 Lm (700mA)	467,00 A
SL230DWBX30	<b>NEW</b>	INOX 316	INOX 316	4,4W (350mA) 9,2W (700mA)	3000K	580 Lm (350mA) 1030 Lm (700mA)	609,00 A
SL230ZWBX27	<b>NEW</b>	BRONZE	ALUMINIUM	4,4W (350mA) 9,2W (700mA)	2700K	580 Lm (350mA) 1030 Lm (700mA)	467,00 A
SL230ZWBX30	<b>NEW</b>	BRONZE	ALUMINIUM	4,4W (350mA) 9,2W (700mA)	3000K	600 Lm (350mA) 1040 Lm (700mA)	467,00 A

ACCESSOIRES		MATIÈRE	DESCRIPTION	L (mm)		€
GH220B	<b>NEW</b>	NOIR	ALUMINIUM	CYLINDRE ASYMETRIQUE		59,60 A
GH220D	<b>NEW</b>	INOX 316	INOX 316	CYLINDRE ASYMETRIQUE		91,80 A
GH220Z	<b>NEW</b>	BRONZE	ALUMINIUM	CYLINDRE ASYMETRIQUE		59,60 A
GS220B	<b>NEW</b>	NOIR	ALUMINIUM	CYLINDRE BASSE LUMINANCE		59,60 A
GS220D	<b>NEW</b>	INOX 316	INOX 316	CYLINDRE BASSE LUMINANCE		91,80 A
GS220Z	<b>NEW</b>	BRONZE	ALUMINIUM	CYLINDRE BASSE LUMINANCE		59,60 A
PSIP3509W	<b>NEW</b>		DRIVER 1-9W 350mA CC IP65	149		44,00 A
PSIP35018W	<b>NEW</b>		DRIVER 9-18W 350mA CC IP65	149		57,70 A
PSIP70018W	<b>NEW</b>		DRIVER 2-18W 700mA CC IP65	149		56,10 A
PSIP70036W	<b>NEW</b>		DRIVER 18-36W 700mA CC IP65	162		73,40 A
JB2	<b>NEW</b>		BOITE DE RACCORDEMENT SERIE 3 SORTIES IP68			13,60 A
JB4	<b>NEW</b>		BOITE DE CONNEXION SERIE AVEC GEL IP68			54,70 A
JB6	<b>NEW</b>		CONNECTEUR AVEC GEL IP68			29,60 A



NOIR



INOX 316



BRONZE



## SL230 MAINS

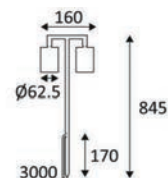
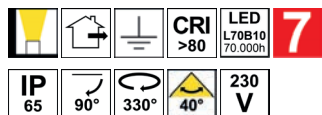

NEW

- Spot d'accentuation pour éclairage extérieur.
- Versions inox 316 pour les zones côtières.
- Câble H05RN-F 3.00m (diamètre 7mm) et piquet à enterrer inclus.
- Convertisseur non dimmable intégré dans l'appareil.
- Boîte de connexion étanche à commander séparément.

SL230 MAINS			MATIÈRE	LED	T°	System Lumen	€
SL230BWBM27	NEW	NOIR	ALUMINIUM	11,4W	2700K	1030 Lm	558,00 A
SL230BWBM30	NEW	NOIR	ALUMINIUM	11,4W	3000K	1040 Lm	558,00 A
SL230DWBM27	NEW	INOX 316	INOX 316	11,4W	2700K	1030 Lm	650,00 A
SL230DWBM30	NEW	INOX 316	INOX 316	11,4W	3000K	1040 Lm	650,00 A
SL230ZWBM30	NEW	BRONZE	ALUMINIUM	11,4W	3000K	1040 Lm	558,00 A

ACCESSOIRES			MATIÈRE	DESCRIPTION		€
GH220B	NEW	NOIR	ALUMINIUM	CYLINDRE ASYMETRIQUE		59,60 A
GH220D	NEW	INOX 316	INOX 316	CYLINDRE ASYMETRIQUE		91,80 A
GH220Z	NEW	BRONZE	ALUMINIUM	CYLINDRE ASYMETRIQUE		59,60 A
GS220B	NEW	NOIR	ALUMINIUM	CYLINDRE BASSE LUMINANCE		59,60 A
GS220D	NEW	INOX 316	INOX 316	CYLINDRE BASSE LUMINANCE		91,80 A
GS220Z	NEW	BRONZE	ALUMINIUM	CYLINDRE BASSE LUMINANCE		59,60 A
JB5	NEW			BOITE DE CONNEXION PARALLELE AVEC GEL IP68		54,70 A



### WL220 MAINS

DANS LA MÊME GAMME  
PAGE 522



NOIR



INOX 316



BRONZE

## SL240

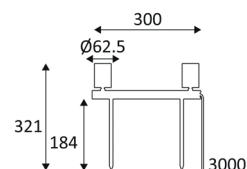
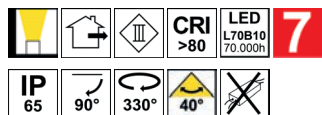

- Spot d'accentuation pour éclairage extérieur.
- Câble H05RN-F 3.00m (diamètre 6mm) et piquets à enterrer inclus.
- Convertisseur 350mA ou 700mA à commander séparément.
- Boîte de raccordement étanche à commander séparément.

SL240		MATIÈRE	LED	T°	System Lumen	€	
SL240WBX27	<b>NEW</b>	NOIR	ALUMINIUM	4,4W (350mA) 9,2W (700mA)	2700K	580 Lm (350mA) 1030 Lm (700mA)	460,00 A
SL240WBX30	<b>NEW</b>	NOIR	ALUMINIUM	4,4W (350mA) 9,2W (700mA)	3000K	600 Lm (350mA) 1040 (700mA)	460,00 A
SL240ZWBX27	<b>NEW</b>	BRONZE	ALUMINIUM	4,4W (350mA) 9,2W (700mA)	2700K	580 Lm (350mA) 1030 Lm (700mA)	460,00 A
SL240ZWBX30	<b>NEW</b>	BRONZE	ALUMINIUM	4,4W (350mA) 9,2W (700mA)	3000K	600 Lm (350mA) 1040 (700mA)	460,00 A

ACCESSOIRES		MATIÈRE	DESCRIPTION	L (mm)		€
GH220B	<b>NEW</b>	NOIR	ALUMINIUM	CYLINDRE ASYMETRIQUE		59,60 A
GH220Z	<b>NEW</b>	BRONZE	ALUMINIUM	CYLINDRE ASYMETRIQUE		59,60 A
GS220B	<b>NEW</b>	NOIR	ALUMINIUM	CYLINDRE BASSE LUMINANCE		59,60 A
GS220Z	<b>NEW</b>	BRONZE	ALUMINIUM	CYLINDRE BASSE LUMINANCE		59,60 A
PSIP3509W	<b>NEW</b>		DRIVER 1-9W 350mA CC IP65	149		44,00 A
PSIP35018W	<b>NEW</b>		DRIVER 9-18W 350mA CC IP65	149		57,70 A
PSIP70018W	<b>NEW</b>		DRIVER 2-18W 700mA CC IP65	149		56,10 A
PSIP70036W	<b>NEW</b>		DRIVER 18-36W 700mA CC IP65	162		73,40 A
JB2	<b>NEW</b>		BOITE DE RACCORDEMENT SERIE 3 SORTIES IP68			13,60 A
JB4	<b>NEW</b>		BOITE DE CONNEXION SERIE AVEC GEL IP68			54,70 A
JB6	<b>NEW</b>		CONNECTEUR AVEC GEL IP68			29,60 A



NOIR



BRONZE

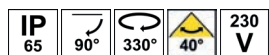

**SL240 MAINS**



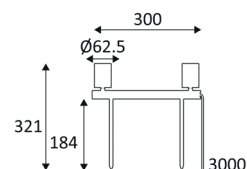



collingwood



NEW

- Spot d'accentuation pour éclairage extérieur.
- Versions inox 316 pour les zones côtières.
- Câble H05RN-F 3.00m (diamètre 7mm) et piquets à enterrer inclus.
- Convertisseur non dimmable intégré dans l'appareil.
- Boîte de connexion étanche à commander séparément.

SL240 MAINS		MATIÈRE	LED	T°	System Lumen	€
SL240BWB27	<b>NEW</b>	NOIR	ALUMINIUM	11,4W	2700K	1030 Lm 549,00 A
SL240BWB30	<b>NEW</b>	NOIR	ALUMINIUM	11,4W	3000K	1040 Lm 549,00 A
SL240DWB30	<b>NEW</b>	INOX 316	INOX 316	11,4W	3000K	1040 Lm 640,00 A
SL240ZWB27	<b>NEW</b>	BRONZE	ALUMINIUM	11,4W	2700K	1030 Lm 549,00 A
SL240ZWB30	<b>NEW</b>	BRONZE	ALUMINIUM	11,4W	3000K	1040 Lm 549,00 A

ACCESSOIRES		MATIÈRE	DESCRIPTION		€
GH220B	<b>NEW</b>	NOIR	ALUMINIUM	CYLINDRE ASYMETRIQUE	 59,60 A
GH220D	<b>NEW</b>	INOX 316	INOX 316	CYLINDRE ASYMETRIQUE	 91,80 A
GH220Z	<b>NEW</b>	BRONZE	ALUMINIUM	CYLINDRE ASYMETRIQUE	 59,60 A
GS220B	<b>NEW</b>	NOIR	ALUMINIUM	CYLINDRE BASSE LUMINANCE	 59,60 A
GS220D	<b>NEW</b>	INOX 316	INOX 316	CYLINDRE BASSE LUMINANCE	 91,80 A
GS220Z	<b>NEW</b>	BRONZE	ALUMINIUM	CYLINDRE BASSE LUMINANCE	 59,60 A
JB5	<b>NEW</b>			BOITE DE CONNEXION PARALLELE AVEC GEL IP68	 54,70 A

**WL220 MAINS**DANS LA MÊME GAMME  
PAGE 522

NOIR



INOX 316



BRONZE

## SL250

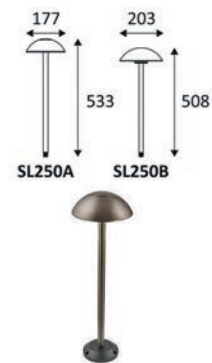

- Luminaire d'accentuation pour éclairage extérieur.
- Câble H05RN-F 1.00m (diamètre 6mm) et piquet à enterrer inclus.
- Base pour montage en surface en option.
- Convertisseur 24VDC à commander séparément.
- Boîte de raccordement étanche à commander séparément.

SL250		MATIÈRE	LED	T°	LED Lumen	System Lumen	L (mm)	€	
SL250BPX0X27	NEW	NOIR MAT	ALUMINIUM	6W	2700K	520 Lm	200 Lm	203	149,00 A
SL250BPX0X30	NEW	NOIR MAT	ALUMINIUM	6W	3000K	560 Lm	220 Lm	203	149,00 A
SL250ATX0X27	NEW	LAITON	LAITON	6W	2700K	520 Lm	200 Lm	177	261,00 A
SL250ATX0X30	NEW	LAITON	LAITON	6W	3000K	560 Lm	220 Lm	177	261,00 A

ACCESSOIRES		MATIÈRE	DESCRIPTION	L (mm)	€
SL250A1	NEW	NOIR MAT	ALUMINIUM	BASE POUR MONTAGE EN SURFACE 120mm	16,70 A
CD178	NEW		DRIVER 75W 24V CV IP67	155	72,30 A
CD179	NEW		DRIVER 100W 24V CV IP67	206	121,70 A
CD180	NEW		DRIVER 150W 24V CV IP67	206	125,10 A
CD181	NEW		DRIVER 250W 24V CV IP67	258	221,70 A
JB1	NEW		BOITE DE RACCORDEMENT SERIE 3 SORTIES IP68		13,60 A
JB5	NEW		BOITE DE CONNEXION SERIE AVEC GEL IP68		54,70 A
JB6	NEW		CONNECTEUR AVEC GEL IP68		29,60 A
WCR275BLACK	NEW		CABLE H05RN-F 2x0,75mm <sup>2</sup> 1m		8,80 A



NOIR MAT

LAITON



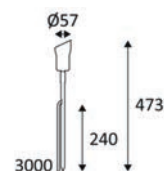
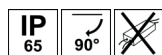

**SL040A**

NEW

- Spot d'accentuation pour éclairage extérieur.
- Avec visière basse luminance.
- Câble H05RN-F 3.00m (diamètre 6mm) et piquet à enterrer inclus.
- Convertisseur 700mA à commander séparément.
- Boîte de raccordement étanche à commander séparément.

SL040A		MATIÈRE	LED	T°	System Lumen	α	€
SL040AS27	<b>NEW</b>	NOIR	ALUMINIUM	7W	2700K	377 Lm	18° 219,00 A
SL040ASWW	<b>NEW</b>	NOIR	ALUMINIUM	7W	3000K	413 Lm	18° 219,00 A
SL040AF27	<b>NEW</b>	NOIR	ALUMINIUM	7W	2700K	377 Lm	38° 219,00 A
SL040AFWW	<b>NEW</b>	NOIR	ALUMINIUM	7W	3000K	413 Lm	38° 219,00 A

ACCESSOIRES		DESCRIPTION	L (mm)		€
PSIP70018W	<b>NEW</b>	DRIVER 2-18W 700mA CC IP65	149		56,10 A
PSIP70036W	<b>NEW</b>	DRIVER 18-36W 700mA CC IP65	162		73,40 A
JB2	<b>NEW</b>	BOITE DE RACCORDEMENT SERIE 3 SORTIES IP68			13,60 A
JB4	<b>NEW</b>	BOITE DE CONNEXION SERIE AVEC GEL IP68			54,70 A
JB6	<b>NEW</b>	CONNECTEUR AVEC GEL IP68			29,60 A
WCR275BLACK	<b>NEW</b>	CABLE H05RN-F 2x0,75mm² 1m			8,80 A

# INDIGO

LIGHTING

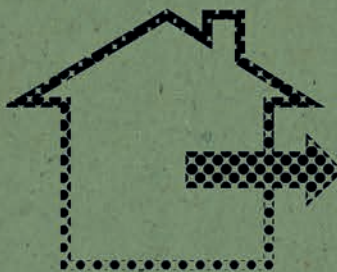

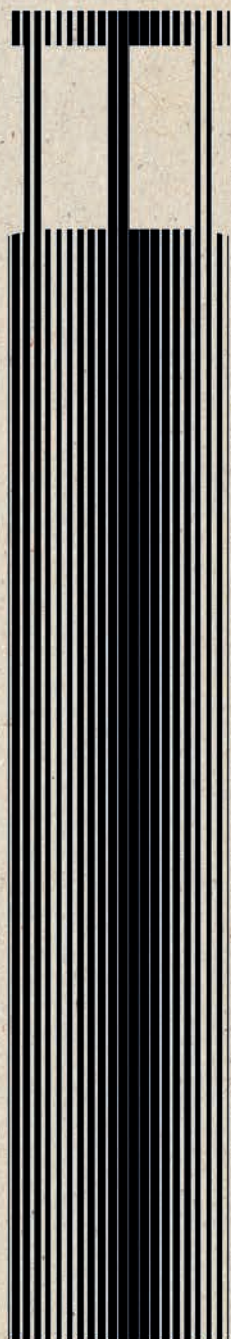

**BORNES**

## MINO P E27

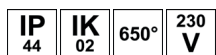

- Borne ronde pour éclairage extérieur.
- Diffuseur en verre dépoli.
- Lampe E27 à commander séparément.

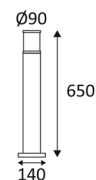

MINO P E27		MATIÈRE	SOCKET	LAMP	Watt Max	€
OU43324	ANTHRACITE	FORTE D'ALUMINIUM	E27	CLA	26W	117,40 B



### MINO W E27

DANS LA MÊME GAMME  
PAGE 505

## RONDO P E27

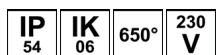

- Borne ronde pour éclairage extérieur.
- Corps anthracite et diffuseur en verre clair ou opalin.
- Lampe E27 à commander séparément.

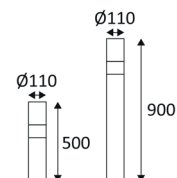

RONDO P E27		MATIÈRE	SOCKET	LAMP	Watt Max	L (mm)	€
OU40024	ANT. + VERRE OPALIN	FORTE D'ALUMINIUM	E27	CLA	18W	500	154,50 B
OU40224	ANT. + VERRE CLAIR	FORTE D'ALUMINIUM	E27	CLA	18W	500	154,50 B
OU40124	ANT. + VERRE OPALIN	FORTE D'ALUMINIUM	E27	CLA	18W	900	205,00 B
OU40324	ANT. + VERRE CLAIR	FORTE D'ALUMINIUM	E27	CLA	18W	900	205,00 B



ANT. + VERRE OPALIN    ANT. + VERRE CLAIR



### RONDO W E27

DANS LA MÊME GAMME  
PAGE 505

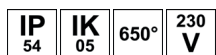

**TULO E27**

- Borne carrée pour éclairage extérieur.
- Diffuseur en verre clair.
- Lampe E27 à commander séparément.

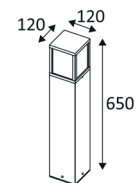

TULO E27	MATÈRE	SOCKET	LAMP	Watt Max	€
OU41424	ANTHRACITE	ALUMINIUM	E27	CLA	15W 184,40 B

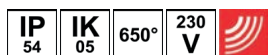
**TULO SENSOR E27**

- Borne carrée pour éclairage extérieur.
- Avec détecteur IR 100°, rayon de détection max. 6m.
- Diffuseur en verre clair.
- Lampe E27 à commander séparément.

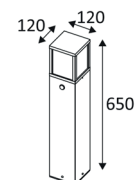

TULO SENSOR E27	MATÈRE	SOCKET	LAMP	Watt Max	€
OU41324	ANTHRACITE	ALUMINIUM	E27	CLA	15W 208,10 B



## ELNE 1



- Luminaire extérieur pour balisage.
- Une fenêtre.
- Avec entrée et sortie de câble.
- Carrossable résistance 500kg.
- Convertisseur non dimmable intégré dans l'appareil.

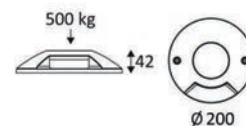

ELNE 1	MATIÈRE	LED	T°	LED Lumen	System Lumen	€	
OU450WW24	ANTHRACITE	ALUMINIUM	6W	3000K	400 Lm	291 Lm	120,50 B

## ELNE 2

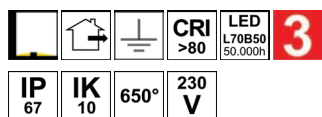

- Luminaire extérieur pour balisage.
- Deux fenêtres.
- Avec entrées et sortie de câble.
- Carrossable résistance 500kg.
- Convertisseur non dimmable intégré dans l'appareil.

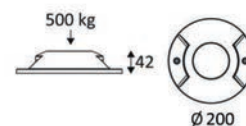

ELNE 2	MATIÈRE	LED	T°	LED Lumen	System Lumen	€	
OU451WW24	ANTHRACITE	ALUMINIUM	2x6W	3000K	800 Lm	343 Lm	131,80 B

## ELNE 4

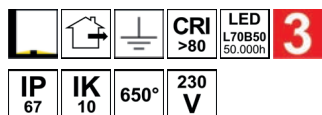

- Luminaire extérieur pour balisage.
- Quatre fenêtres.
- Avec entrée et sortie de câble.
- Carrossable résistance 500kg.
- Convertisseur non dimmable intégré dans l'appareil.

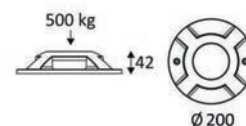

ELNE 4	MATIÈRE	LED	T°	LED Lumen	System Lumen	€	
OU452WW24	ANTHRACITE	ALUMINIUM	4x3W	3000K	1200 Lm	511 Lm	144,20 B





## LUXI 54

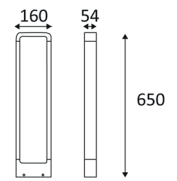
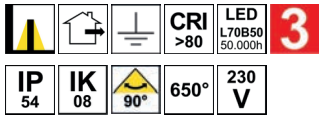

- Borne rectangulaire pour éclairage extérieur.
- Convertisseur non dimmable intégré dans l'appareil.

LUXI 54	MATIÈRE	LED	T°	LED Lumen	System Lumen	€
OU13624	ANTHRACITE ALUMINIUM	7W	3000K	750 Lm	524 Lm	215,30 B





## CUBIC P

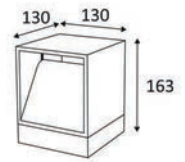
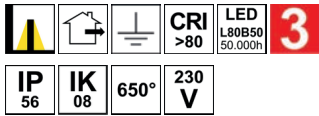

- Borne carrée pour éclairage extérieur.
- Convertisseur non dimmable intégré dans l'appareil.

CUBIC P	MATIÈRE	LED	T°	LED Lumen	System Lumen	€
OU316NW24	ANTHRACITE	9W	4000K	380 Lm	220 Lm	289,40 B

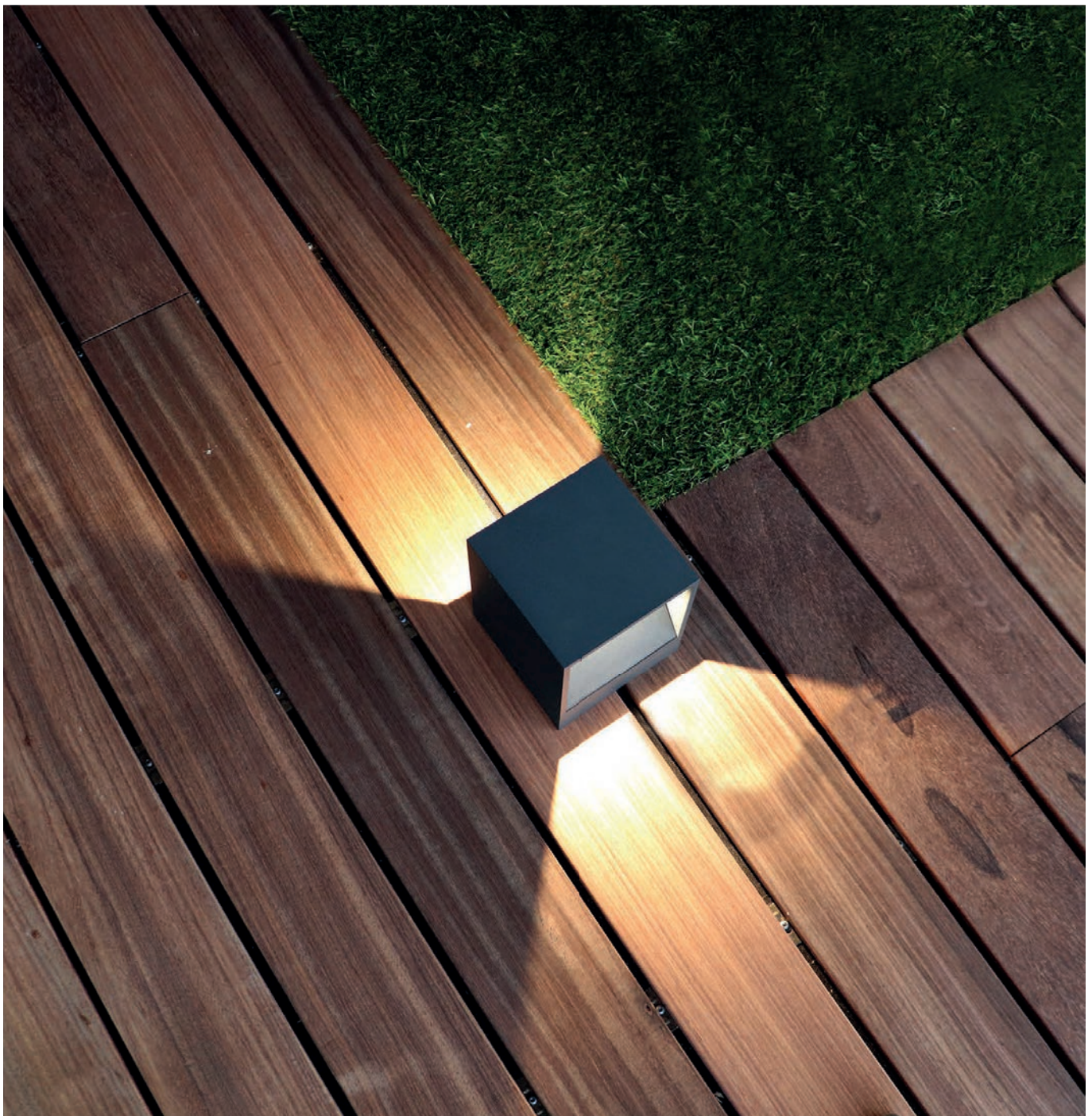

## STELLA

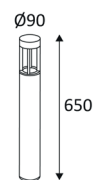

- Borne ronde pour éclairage extérieur.
- Convertisseur non dimmable intégré dans l'appareil.

STELLA		MATIÈRE	LED	T°	LED Lumen	System Lumen	€
OU353WW24	■ ANTHRACITE	FONTE D'ALUMINIUM	8W	3000K	825 Lm	500 Lm	170,00 B
OU353NW24	■ ANTHRACITE	FONTE D'ALUMINIUM	8W	4000K	900 Lm	595 Lm	170,00 B

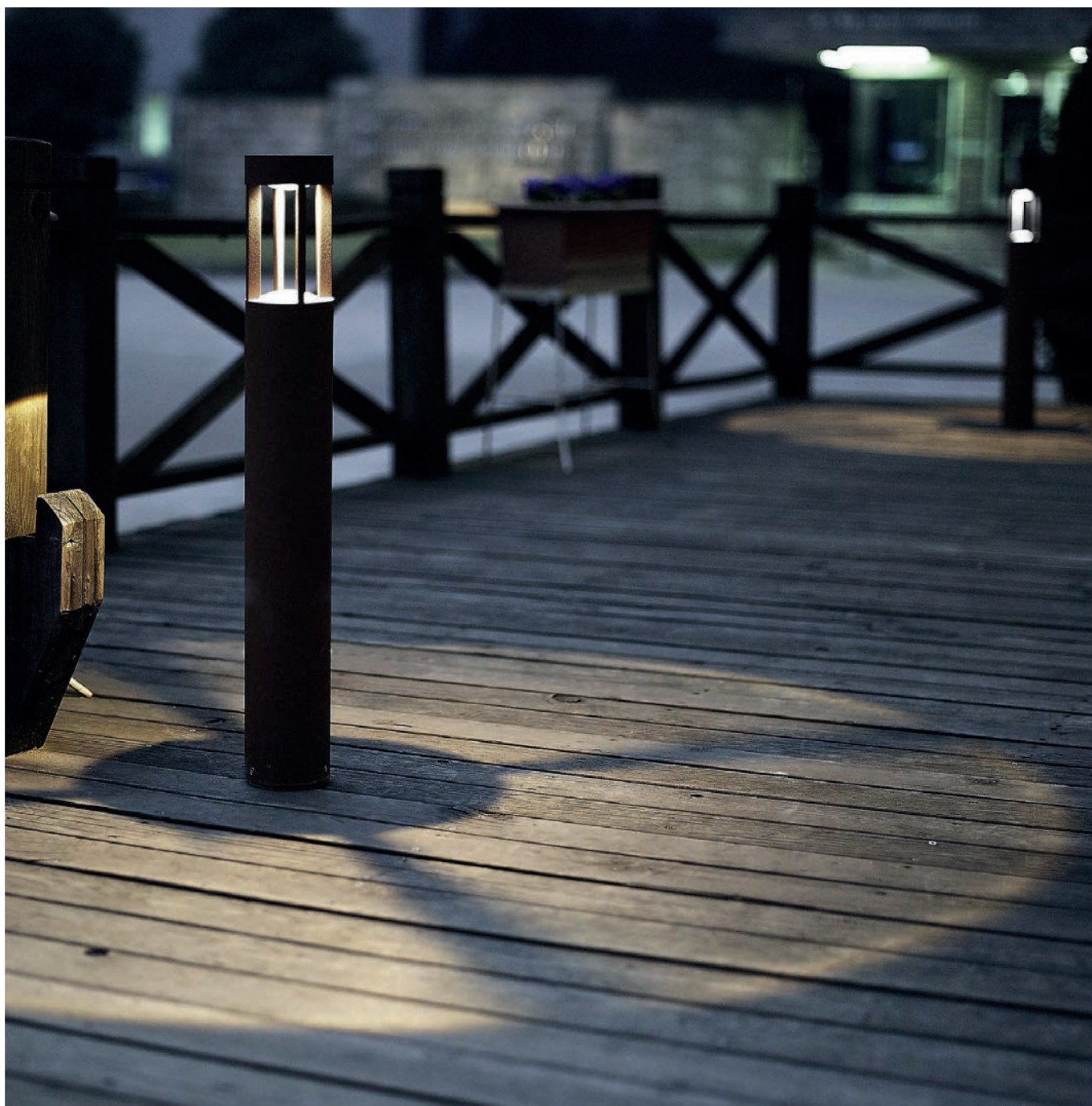



## LUXI 180

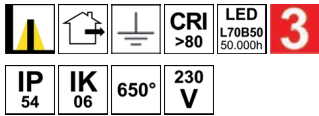

- Borne carrée pour éclairage extérieur.
- Peut être utilisé comme éclairage portatif grâce à la sortie de câble latérale.
- Convertisseur non dimmable intégré dans l'appareil.

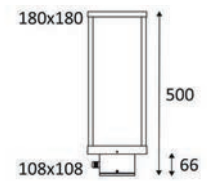

LUXI 180	MATIÈRE	LED	T°	LED Lumen	System Lumen	€
OU318NW24	ANTHRACITE	12W	4000K	1100 Lm	720 Lm	255,40 B



## RAVEL

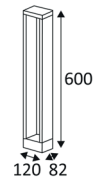
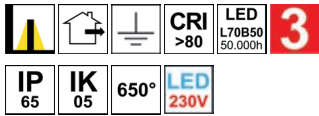

- Borne rectangulaire pour éclairage extérieur.
- Ne nécessite pas de convertisseur.

RAVEL	MATIÈRE	LED	T°	LED Lumen	System Lumen	€
OU354NW24	ANTHRACITE	10W	4000K	1100 Lm	577 Lm	180,30 B





## FINN P



- Borne ronde pour éclairage extérieur.
- Diffuseur en polycarbonate.
- Ne nécessite pas de convertisseur.

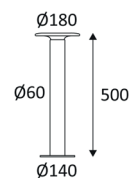

FINN P	MATIÈRE	LED	T°	LED Lumen	System Lumen	€	
OU503WW05	NOIR MAT	ALUMINIUM	10W	3000K	1100 Lm	935 Lm	141,10 B



### FINN W

DANS LA MÊME GAMME  
PAGE 515

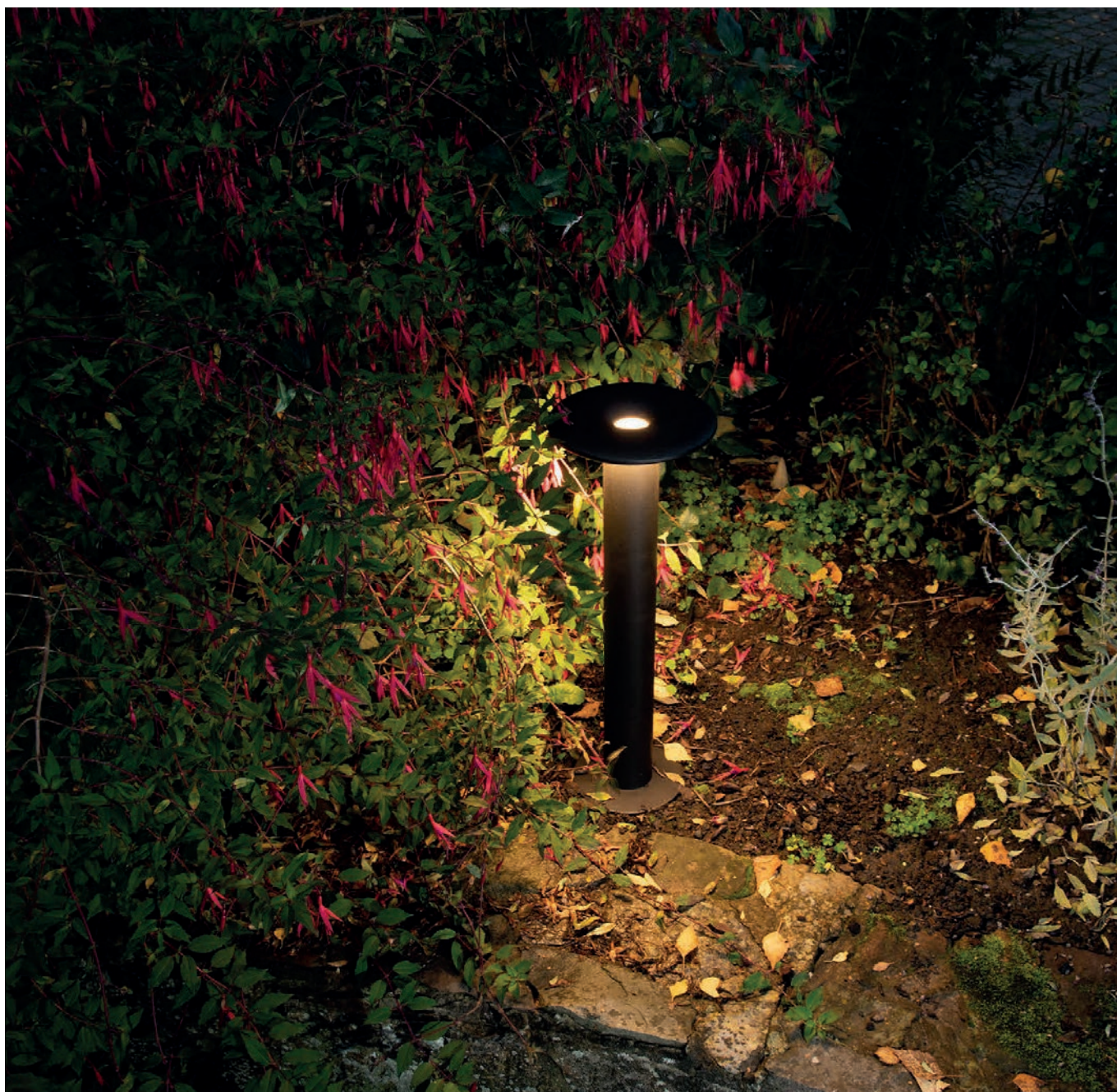

## AMONT

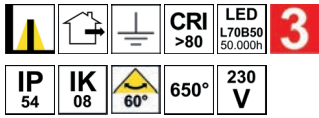

- Borne rectangulaire pour éclairage extérieur.
- Convertisseur non dimmable intégré dans l'appareil.

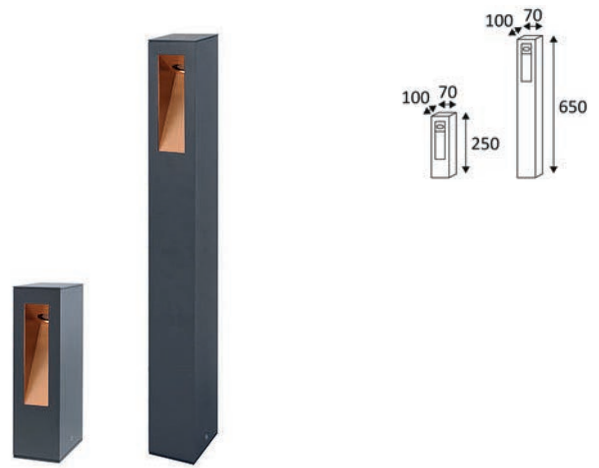

AMONT		MATIÈRE	LED	T°	LED Lumen	System Lumen	L (mm)	€
OU357WW24	ANTHRACITE - DORE	ALUMINIUM	7W	3000K	750 Lm	90 Lm	250	131,80 B
OU358WW24	ANTHRACITE - DORE	ALUMINIUM	7W	3000K	750 Lm	90 Lm	650	172,00 B

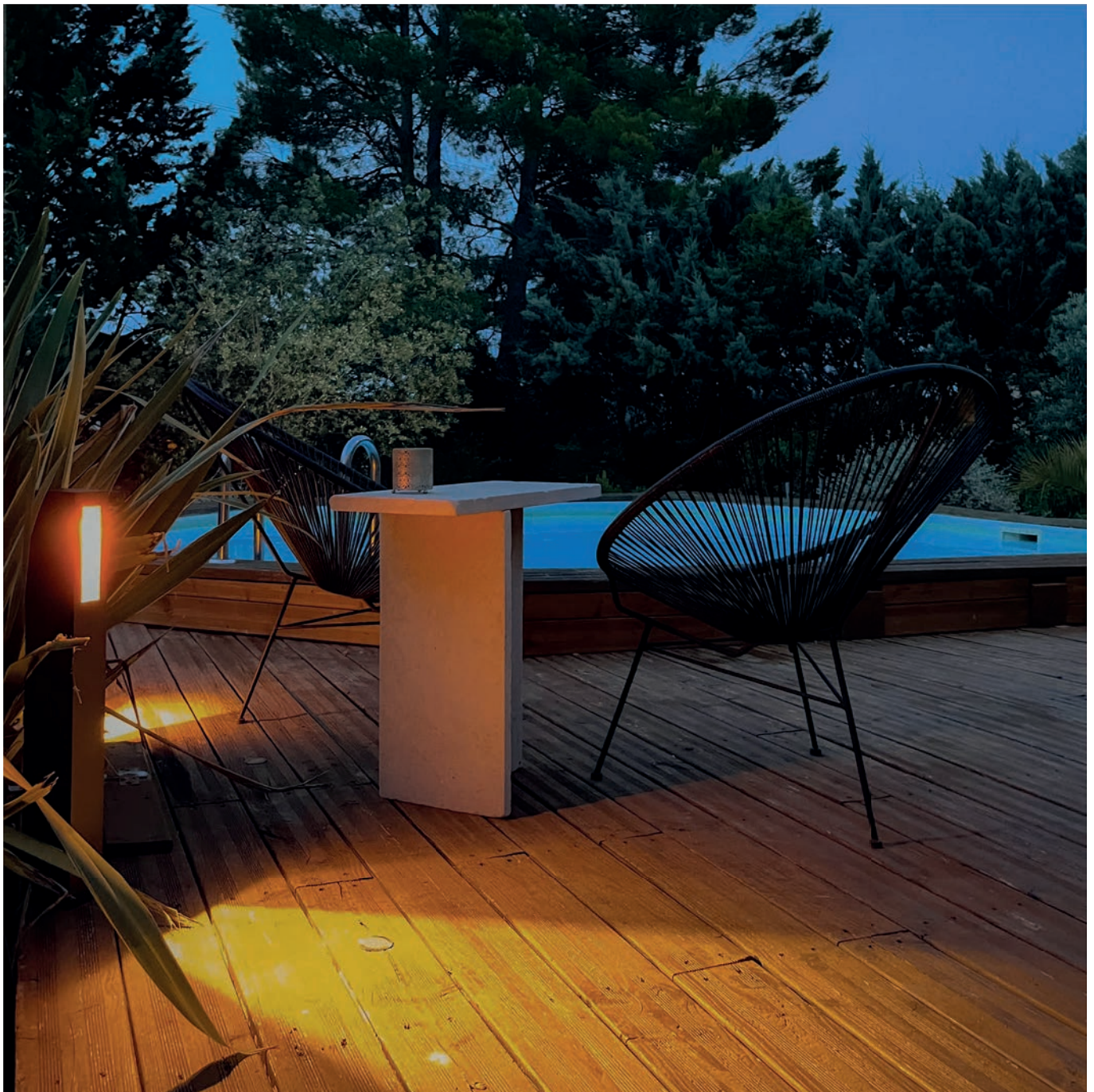





## LUXI 650

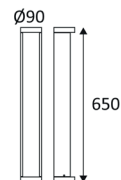
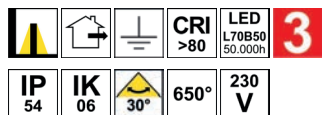

- Borne ronde pour éclairage extérieur.
- Avec entrée et sortie de câble.
- Convertisseur non dimmable intégré dans l'appareil.

LUXI 650		MATIÈRE	LED	T°	LED Lumen	System Lumen	€
OU13824	■ ANTHRACITE	FORTE D'ALUMINIUM	7W	3000K	660 Lm	476 Lm	197,80 B

## BREST

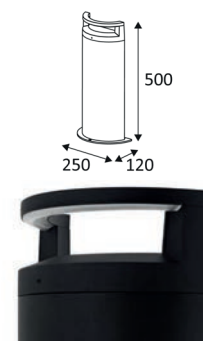
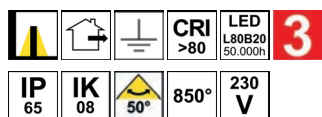

- Borne arrondie pour éclairage extérieur.
- Convertisseur non dimmable intégré dans l'appareil.

BREST		MATIÈRE	LED	T°	LED Lumen	System Lumen	€
OU507WW05	■ NOIR MAT	ALUMINIUM	10W	3000K	1150 Lm	520 Lm	224,50 B



## LUXI 100 S P



- Borne carrée pour éclairage extérieur.
- Convertisseur non dimmable intégré dans l'appareil.

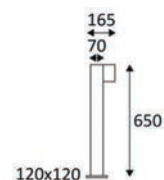

LUXI 100 S P	MATIÈRE	LED	T°	LED Lumen	System Lumen	€
OU356WW24	ANTHRACITE ALUMINIUM	7W	3000K	660 Lm	465 Lm	189,50 B



**LUXI 100 S**  
DANS LA MÊME GAMME  
PAGE 526



## CHASE

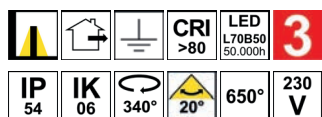

- Borne ronde pour éclairage extérieur.
- Convertisseur non dimmable intégré dans l'appareil.

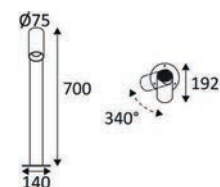

CHASE	MATIÈRE	LED	T°	LED Lumen	System Lumen	€
OU480WW24	ANTHRACITE ALUMINIUM	7W	3000K	700 Lm	300 Lm	185,40 B



## OLA 2



- Borne carrée pour éclairage extérieur.
- Convertisseur non dimmable intégré dans l'appareil.
- Accessoire inclus : plaque occultante amovible.

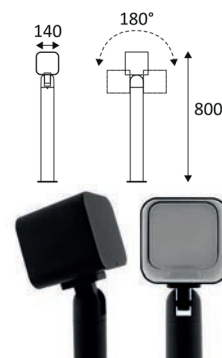

OLA 2	MATIÈRE	LED	T°	LED Lumen	System Lumen	€	
OU481WW05	NOIR MAT	ALUMINIUM	6W	3000K	825 Lm	280 Lm	224,50 B



### OLA 1

DANS LA MÊME GAMME  
PAGE 434



## BENS P

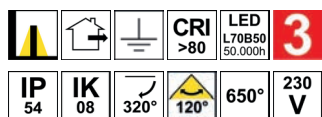

- Borne rectangulaire pour éclairage extérieur.
- Convertisseur non dimmable intégré dans l'appareil.

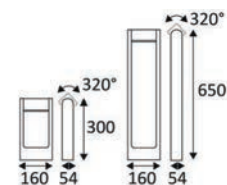

BENS P		MATIÈRE	LED	T°	LED Lumen	System Lumen	L (mm)	€
OU361WW24	■ ANTHRACITE	ALUMINIUM	6W	3000K	600 Lm	433 Lm	300	158,60 B
OU362WW24	■ ANTHRACITE	ALUMINIUM	6W	3000K	600 Lm	433 Lm	650	189,50 B



### BENS W

DANS LA MÊME GAMME  
PAGE 527

## SETO

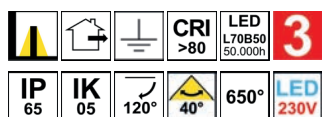

- Borne ronde pour éclairage extérieur.
- Ne nécessite pas de convertisseur.

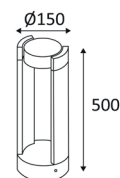

SETO		MATIÈRE	LED	T°	LED Lumen	System Lumen	€
OU336NW24	■ ANTHRACITE	FONTE D'ALUMINIUM	10W	4000K	970 Lm	562 Lm	213,20 B





### AVI 1

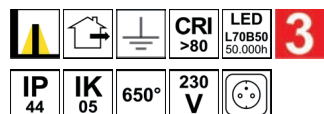

- Borne ronde pour éclairage extérieur.
- Avec prises 2P + T 16A max. 2x2000W.
- Avec alimentations distinctes pour éclairage et prises.
- Convertisseur non dimmable intégré dans l'appareil.



AVI 1		MATIÈRE	LED	T°	LED Lumen	System Lumen	€
OU415WW24	■	ANTHRACITE	4W	3000K	475 Lm	175 Lm	208,10 B
OU415NW24	■	ANTHRACITE	4W	4000K	480 Lm	170 Lm	208,10 B

### AVI 2

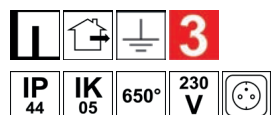

- Borne ronde pour extérieur.
- Avec prises 2P + T 16A max. 2x2000W.

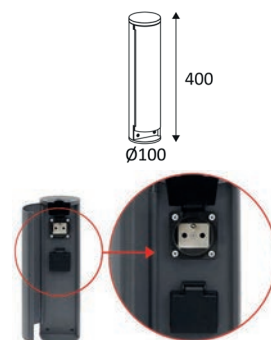

AVI 2		MATIÈRE	€
OU46324	■	ANTHRACITE	140,10 B



## FILO P

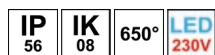

- Borne ronde pour éclairage extérieur.
- Diffuseur en polycarbonate opalin.
- Ne nécessite pas de convertisseur.

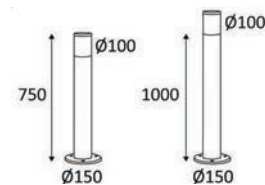

FILO P		MATIÈRE	LED	T°	LED Lumen	System Lumen	L (mm)	€
OU17724	■ ANTHRACITE	FORTE D'ALUMINIUM	8W	3000K	420 Lm	355 Lm	750	293,60 B
OU17824	■ ANTHRACITE	FORTE D'ALUMINIUM	8W	3000K	420 Lm	355 Lm	1000	325,50 B

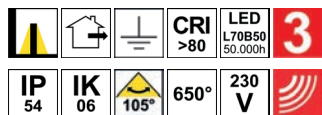

**LUXI 175 SENSOR P**

- Borne rectangulaire pour éclairage extérieur.
- Avec détecteur HF 120°, zone de détection réglable max. 8m.
- Diffuseur en polycarbonate opalin.
- Convertisseur non dimmable intégré dans l'appareil.

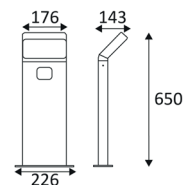

LUXI 175 SENSOR P		MATIÈRE	LED	T°	LED Lumen	System Lumen	€
OU367WW24	■ ANTHRACITE	ALUMINIUM	9W	3000K	1260 Lm	760 Lm	289,40 B
OU367NW24	■ ANTHRACITE	ALUMINIUM	9W	4000K	1300 Lm	785 Lm	289,40 B

**LUXI 175 SENSOR**

DANS LA MÊME GAMME  
PAGE 538







## LUXI 80

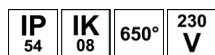

- Borne ronde pour éclairage extérieur.
- Diffuseur en polycarbonate opalin.
- Convertisseur non dimmable intégré dans l'appareil.

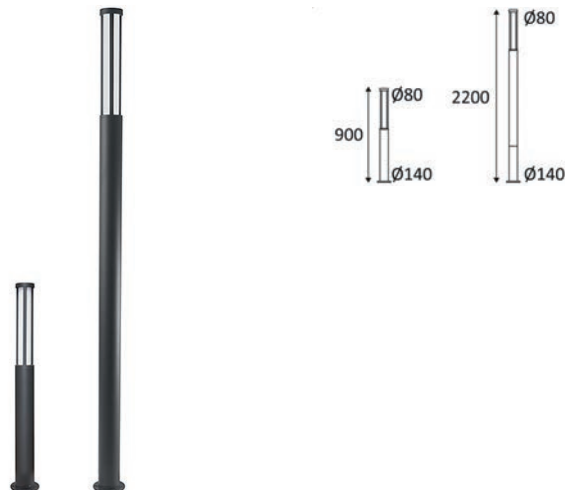

LUXI 80		MATIÈRE	LED	T°	LED Lumen	System Lumen	L (mm)	€	
OU324WW24	■	ANTHRACITE	18W	3000K	2340 Lm	1325 Lm	900	281,20	B
OU324NW24	■	ANTHRACITE	18W	4000K	2410 Lm	1750 Lm	900	281,20	B
OU325WW24	■	ANTHRACITE	18W	3000K	2340 Lm	1325 Lm	2200	537,70	B
OU325NW24	■	ANTHRACITE	18W	4000K	2410 Lm	1750 Lm	2200	537,70	B

## BOL201

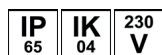

- Borne ronde pour éclairage extérieur.
- Diffuseur opalin.
- Convertisseur non dimmable intégré dans l'appareil.
- Boîte de connexion étanche à commander séparément.

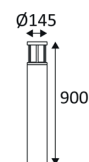

BOL201		MATIÈRE	LED	T°	LED Lumen	System Lumen	€	
BOL201X30	NEW ■	NOIR	23W	3000K	2300 Lm	930 Lm	497,20	A

ACCESSOIRES	DESCRIPTION	€
JB5	NEW BOITE DE CONNEXION PARALLELE AVEC GEL IP68	54,70 A



## CYCLO

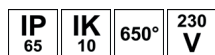

- Borne ronde pour éclairage extérieur.
- Diffuseur en polycarbonate.
- Convertisseur non dimmable intégré dans l'appareil.

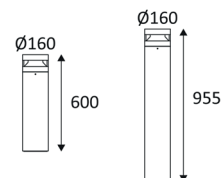

CYCLO	MATIÈRE	LED	T°	LED Lumen	System Lumen	L (mm)	€
OU515WW24	■ ANTHRACITE FONTE D'ALUMINIUM	24W	3000K	2100 Lm	1660 Lm	600	441,90 B
OU390WW24	■ ANTHRACITE FONTE D'ALUMINIUM	24W	3000K	2100 Lm	1660 Lm	955	475,90 B

ACCESSOIRES	MATIÈRE	DESCRIPTION	€
OU39224	■ ANTHRACITE FONTE D'ALUMINIUM	REFLECTEUR 180°	35,00 B

## CYCLO SENSOR

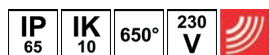

- Borne ronde pour éclairage extérieur.
- Diffuseur en polycarbonate.
- Avec détecteur IR 90°, zone de détection réglable max. 5m.
- Convertisseur non dimmable intégré dans l'appareil.

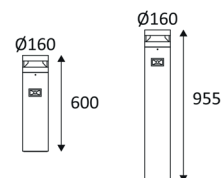

CYCLO SENSOR	MATIÈRE	LED	T°	LED Lumen	System Lumen	L (mm)	€
OU516WW24	■ ANTHRACITE FONTE D'ALUMINIUM	24W	3000K	2100 Lm	1660 Lm	600	482,00 B
OU391WW24	■ ANTHRACITE FONTE D'ALUMINIUM	24W	3000K	2100 Lm	1660 Lm	955	508,80 B

ACCESSOIRES	MATIÈRE	DESCRIPTION	€
OU39224	■ ANTHRACITE FONTE D'ALUMINIUM	REFLECTEUR 180°	35,00 B



# INDIGO

LIGHTING

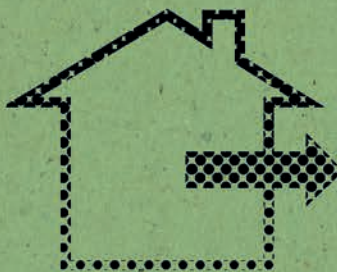

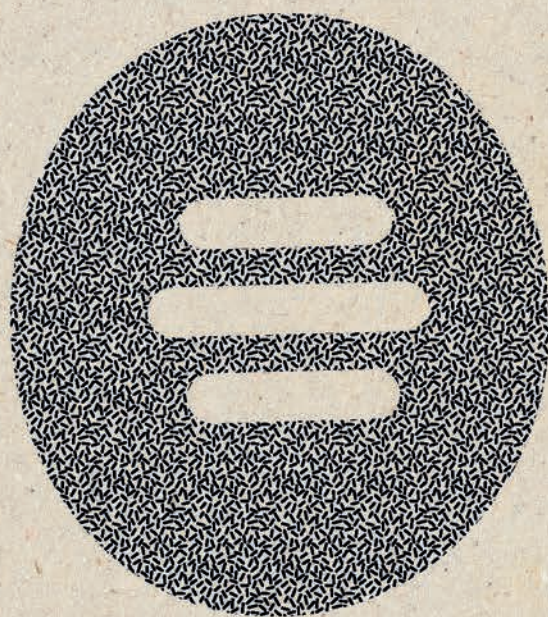

**ENCASTRÉS MURAUX**

## ML01

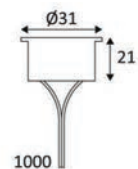
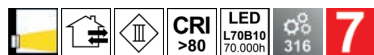

- Encastré mural décoratif rond.
- 1m de câble fourni.
- Convertisseur 350mA à commander séparément.

ML01		MATIÈRE	LED	T°	LED Lumen	System Lumen	€
ML0127	NEW	ARGENT	INOX 316	1W	2700K	80 Lm	4 Lm 114,30 A
ML01WW	NEW	ARGENT	INOX 316	1W	3000K	90 Lm	4 Lm 114,30 A
ML01NW	NEW	ARGENT	INOX 316	1W	4000K	90 Lm	4 Lm 114,30 A

ACCESSOIRES		DESCRIPTION	L (mm)		€
PLR35015	NEW	DRIVER 1-5W 350mA CC	53		43,90 A
PLU35019	NEW	DRIVER 1-9W 350mA CC	111		50,90 A
PSIP3509W	NEW	DRIVER 1-9W 350mA CC IP65	149		44,00 A
PSIP35018W	NEW	DRIVER 9-18W 350mA CC IP65	149		57,70 A

## ML02

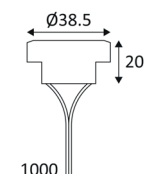
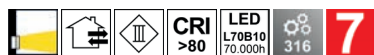

- Encastré mural décoratif rond.
- 1m de câble fourni.
- Convertisseur 350mA à commander séparément.

ML02		MATIÈRE	LED	T°	LED Lumen	System Lumen	€
ML0227	NEW	ARGENT	INOX 316	1W	2700K	80 Lm	23 Lm 133,50 A
ML02NW	NEW	ARGENT	INOX 316	1W	4000K	90 Lm	35 Lm 133,50 A

ACCESSOIRES		DESCRIPTION	L (mm)		€
PLR35015	NEW	DRIVER 1-5W 350mA CC	53		43,90 A
PLU35019	NEW	DRIVER 1-9W 350mA CC	111		50,90 A
PSIP3509W	NEW	DRIVER 1-9W 350mA CC IP65	149		44,00 A
PSIP35018W	NEW	DRIVER 9-18W 350mA CC IP65	149		57,70 A

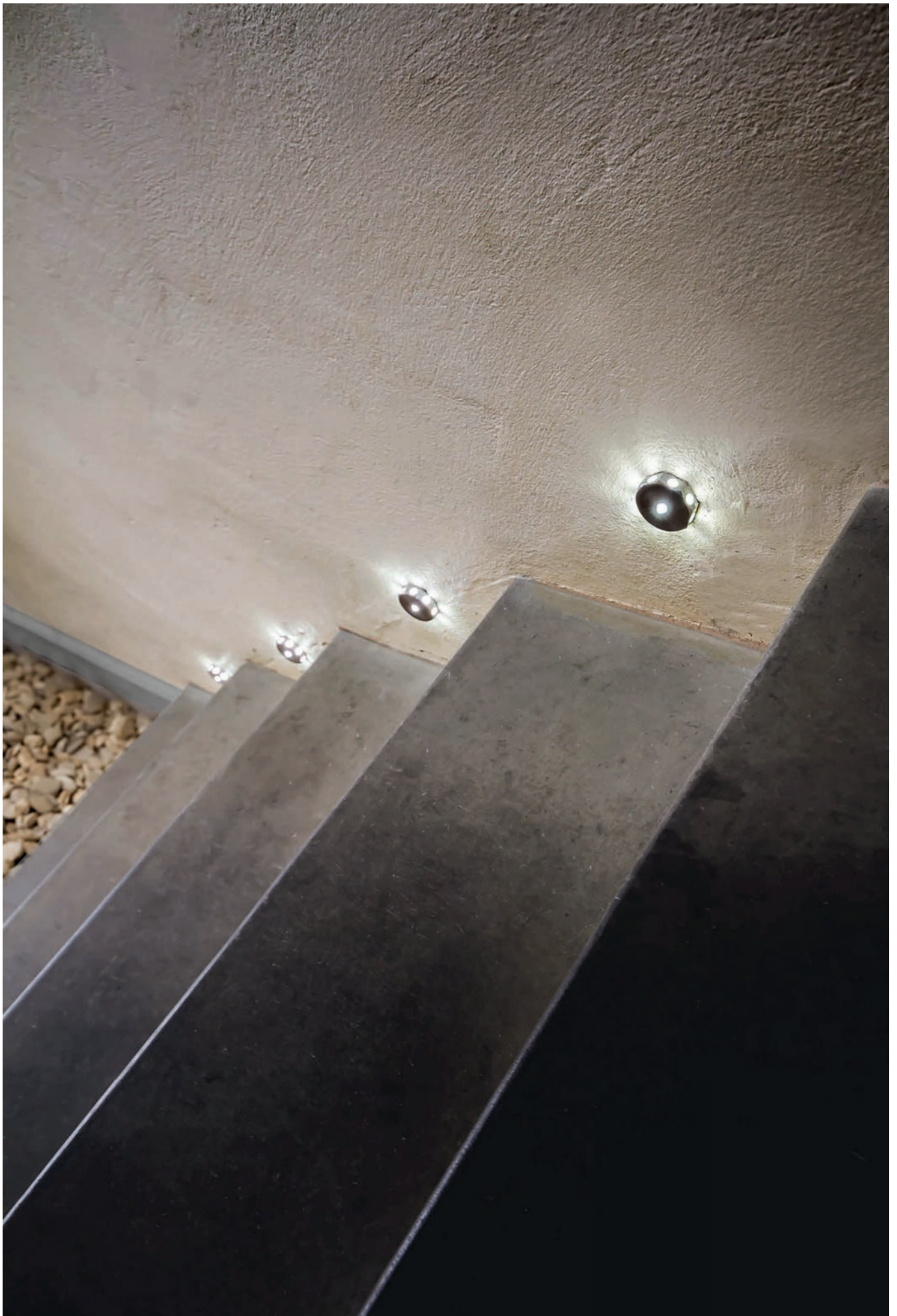

## GL021

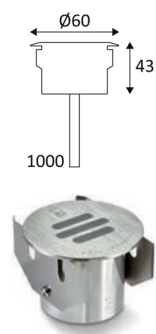

- Encastré mural extérieur rond pour balisage.
- Inox 316 pour les zones côtières.
- 1m de câble H05RN-F fourni (diamètre 6mm).
- Convertisseur 350mA à commander séparément.
- Tube d'encastrement et boîte de raccordement étanche à commander séparément.

ALIMENTATION(S)		Watt Max	€
PLR35015	NEW	1-5W	43,90 A
PLU35019	NEW	1-9W	50,90 A
PSIP3509W	NEW	1-9W	44,00 A
PSIP35018W	NEW	9-18W	57,70 A

GL021		MATIÈRE	LED	T°	LED Lumen	System Lumen	€
GL02127	NEW	INOX 316	1W	2700K	80 Lm	8 Lm	156,00 A
GL021WW	NEW	INOX 316	1W	3000K	90 Lm	8 Lm	156,00 A
GL021NW	NEW	INOX 316	1W	4000K	90 Lm	10 Lm	156,00 A

ACCESSOIRES		MATIÈRE	DESCRIPTION	L (mm)		€
TUBE50	NEW	ALUMINIUM	TUBE D'ENCASTREMENT 56x150mm	150		44,60 A
JB2	NEW		BOITE DE RACCORDEMENT SERIE 3 SORTIES IP68			13,60 A
JB4	NEW		BOITE DE CONNEXION SERIE AVEC GEL IP68			54,70 A
JB6	NEW		CONNECTEUR AVEC GEL IP68			29,60 A
WCR275BLACK	NEW		CABLE H05RN-F 2x0,75mm² 1m			8,80 A







## GL022

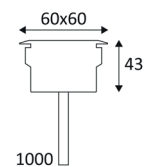

- Encastré mural extérieur carré pour balisage.
- Inox 316 pour les zones côtières.
- 1m de câble H05RN-F fourni (diamètre 6mm).
- Convertisseur 350mA à commander séparément.
- Tube d'encastrement et boîte de raccordement étanche à commander séparément.

ALIMENTATION(S)		Watt Max	€
PLR35015	NEW	1-5W	43,90 A
PLU35019	NEW	1-9W	50,90 A
PSIP3509W	NEW	1-9W	44,00 A
PSIP35018W	NEW	9-18W	57,70 A

GL022	MATIÈRE	LED	T°	LED Lumen	System Lumen	€
GL02227	NEW INOX 316	1W	2700K	80 Lm	8 Lm	156,00 A
GL022WW	NEW INOX 316	1W	3000K	90 Lm	8 Lm	156,00 A
GL022NW	NEW INOX 316	1W	4000K	90 Lm	10 Lm	156,00 A

ACCESSOIRES	MATIÈRE	DESCRIPTION	L (mm)	€
TUBE50	NEW ALUMINIUM	TUBE D'ENCASTREMENT 56x150mm	150	44,60 A
JB2	NEW	BOITE DE RACCORDEMENT SERIE 3 SORTIES IP68		13,60 A
JB4	NEW	BOITE DE CONNEXION SERIE AVEC GEL IP68		54,70 A
JB6	NEW	CONNECTEUR AVEC GEL IP68		29,60 A
WCR275BLACK	NEW	CABLE H05RN-F 2x0,75mm² 1m		8,80 A



## GL019 E

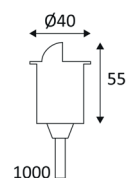
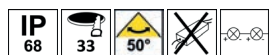

- Semi-encastré mural extérieur rond pour balisage.
- Versions inox 316 pour les zones côtières.
- 1m de câble H05RN-F fourni (diamètre 6mm).
- Convertisseur 350mA ou 700mA à commander séparément.
- Tube d'encastrement et boîte de raccordement étanche à commander séparément.

ALIMENTATION(S)		Watt Max	€
PSIP3509W	NEW	1-9W	44,00 A
PSIP35018W	NEW	9-18W	57,70 A
PSIP70018W	NEW	2-18W	56,10 A
PSIP70036W	NEW	18-36W	73,40 A

GL019 E		MATIÈRE	LED	T°	System Lumen	€	
GL019E27BL	NEW	NOIR	INOX 316	1W (350mA) 2W (700mA)	2700K	31 Lm (350mA) 56 Lm (700mA)	134,00 A
GL019E30BL	NEW	NOIR	INOX 316	1W (350mA) 2W (700mA)	3000K	36 Lm (350mA) 64 Lm (700mA)	134,00 A
GL019E27SS	NEW	INOX 316	INOX 316	1W (350mA) 2W (700mA)	2700K	36 Lm (350mA) 63 Lm (700mA)	134,00 A
GL019E30SS	NEW	INOX 316	INOX 316	1W (350mA) 2W (700mA)	3000K	41 Lm (350mA) 72 Lm (700mA)	134,00 A

ACCESSOIRES		MATIÈRE	DESCRIPTION	L (mm)		€
TUBE332	NEW	ALUMINIUM	TUBE D'ENCASTREMENT 37x150mm	150		43,90 A
JB2	NEW		BOITE DE RACCORDEMENT SERIE 3 SORTIES IP68			13,60 A
JB4	NEW		BOITE DE CONNEXION SERIE AVEC GEL IP68			54,70 A
JB6	NEW		CONNECTEUR AVEC GEL IP68			29,60 A



NOIR



INOX 316

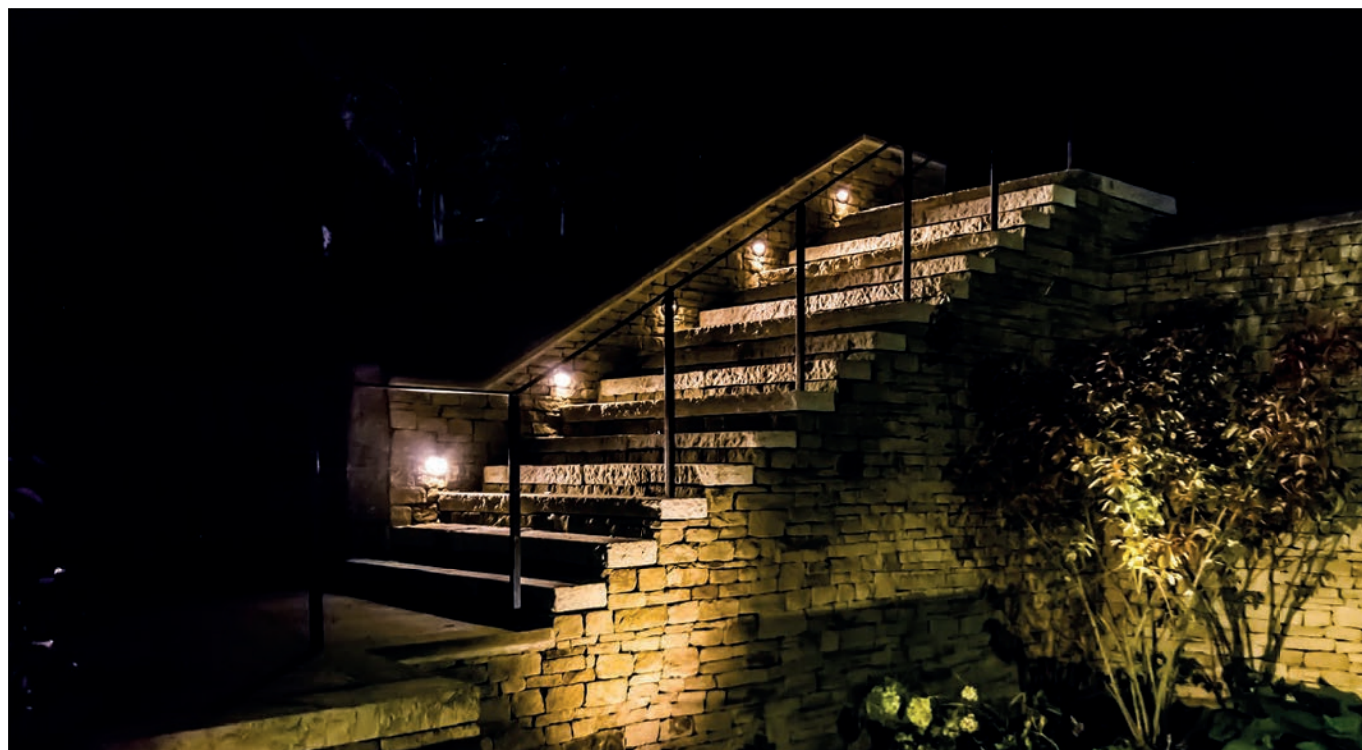



## GL034



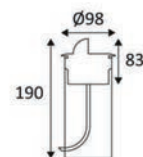

- Semi-encastré mural extérieur rond pour balisage.
- Inox 316 pour les zones côtières.
- Pot d'encastrement et 1m de câble H05RN-F (diamètre 7mm) fournis.
- Convertisseur non dimmable intégré dans l'appareil.
- Boîte de connexion étanche à commander séparément.

collingwood



GL034	MATIÈRE	LED	T°	LED Lumen	System Lumen	€
GL034DWBM27 <b>NEW</b>	INOX 316	2,9W	2700K	240 Lm	170 Lm	379,00 A
GL034DWBM30 <b>NEW</b>	INOX 316	2,9W	3000K	270 Lm	180 Lm	379,00 A
GL034DWBM40 <b>NEW</b>	INOX 316	2,9W	4000K	280 Lm	190 Lm	379,00 A

ACCESSOIRES	DESCRIPTION	€
JB5 <b>NEW</b>	BOITE DE CONNEXION PARALLELE AVEC GEL IP68	 54,70 A
WC59 <b>NEW</b>	CONNECTEUR IP68	 85,20 A

NEW

## SLIT R

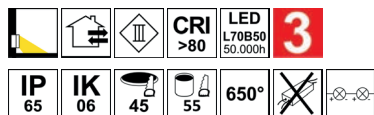

- Encastré mural extérieur rond pour balisage.
- Fixation par lamelles.
- Boîtier d'encastrement et 1.00m de câble fournis.
- Convertisseur 700mA à commander séparément.

Max. 14 SLIT par CD105.

ALIMENTATION(S)	Watt Max	€
CD172	2-4W	15,50 B
CD105	9-35W	95,80 B



SLIT R	MATIÈRE	LED	T°	LED Lumen	System Lumen	€
OU154WW05	NOIR MAT	ALUMINIUM	3000K	170 Lm	30 Lm	93,70 B
OU154WW30	BLANC MAT	ALUMINIUM	3000K	170 Lm	30 Lm	93,70 B



NOIR MAT



BLANC MAT

## SLIT S

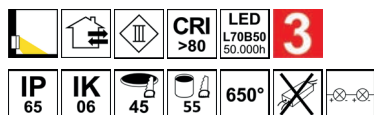

- Encastré mural extérieur carré pour balisage.
- Fixation par lamelles.
- Boîtier d'encastrement et 1.00m de câble fournis.
- Convertisseur 700mA à commander séparément.

Max. 14 SLIT par CD105.

ALIMENTATION(S)	Watt Max	€
CD172	2-4W	15,50 B
CD105	9-35W	95,80 B

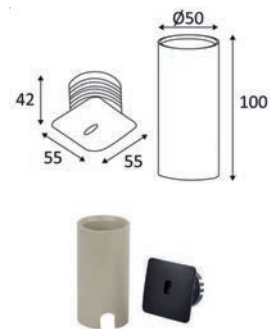

SLIT S	MATIÈRE	LED	T°	LED Lumen	System Lumen	€
OU158WW05	NOIR MAT	ALUMINIUM	3000K	170 Lm	30 Lm	93,70 B
OU158WW30	BLANC MAT	ALUMINIUM	3000K	170 Lm	30 Lm	93,70 B



NOIR MAT



BLANC MAT



## WL340



  
collingwood

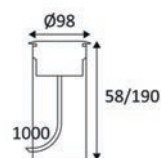

- Encastré mural extérieur rond pour balisage.
- Versions inox 316 pour les zones côtières.
- Pot d'encastrement et 1m de câble H05RN-F (diamètre 7mm) fournis.
- Convertisseur non dimmable intégré dans l'appareil.
- Boîte de connexion étanche à commander séparément.

WL340		MATIÈRE	LED	T°	LED Lumen	System Lumen	€	
WL339WW	<b>NEW</b>	INOX MOULÉ	INOX 316	2,6W	3000K	205 Lm	50 Lm	447,10 A
WL340WW	<b>NEW</b>	INOX BROSSÉ	INOX 316	2,6W	3000K	205 Lm	50 Lm	447,10 A
WL340AB27	<b>NEW</b>	LAITON ANTIQUE	LAITON ANTIQUE	2,6W	2700K	155 Lm	49 Lm	787,00 A
WL340ABWW	<b>NEW</b>	LAITON ANTIQUE	LAITON ANTIQUE	2,6W	3000K	205 Lm	50 Lm	787,00 A

ACCESSOIRES	DESCRIPTION	€
JB5	<b>NEW</b> BOITE DE CONNEXION PARALLELE AVEC GEL IP68	54,70 A
WC59	<b>NEW</b> CONNECTEUR IP68	85,20 A



## WL342



  
collingwood

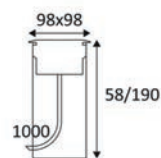

- Encastré mural extérieur carré pour balisage.
- Versions inox 316 pour les zones côtières.
- Pot d'encastrement et 1m de câble H05RN-F (diamètre 7mm) fournis.
- Convertisseur non dimmable intégré dans l'appareil.
- Boîte de connexion étanche à commander séparément.

WL342		MATIÈRE	LED	T°	LED Lumen	System Lumen	€	
WL341WW	<b>NEW</b>	INOX MOULÉ	INOX 316	2,6W	3000K	205 Lm	50 Lm	508,70 A
WL342WW	<b>NEW</b>	INOX BROSSÉ	INOX 316	2,6W	3000K	205 Lm	50 Lm	508,70 A
WL342AB27	<b>NEW</b>	LAITON ANTIQUE	LAITON ANTIQUE	2,6W	2700K	155 Lm	49 Lm	799,90 A
WL342AB30	<b>NEW</b>	LAITON ANTIQUE	LAITON ANTIQUE	2,6W	3000K	205 Lm	50 Lm	799,90 A

ACCESSOIRES	DESCRIPTION	€
JB5	<b>NEW</b> BOITE DE CONNEXION PARALLELE AVEC GEL IP68	54,70 A
WC59	<b>NEW</b> CONNECTEUR IP68	85,20 A



## PURE 190

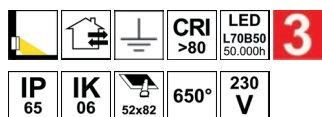

- Encastré mural extérieur rectangulaire pour balisage.
- Boîtier d'encastrement fourni.
- Convertisseur non dimmable intégré dans l'appareil.

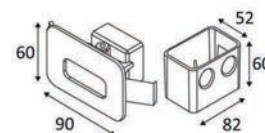

PURE 190		MATIÈRE	LED	T°	LED Lumen	System Lumen	€	
OU190WW24		ANTHRACITE	ALUMINIUM	3W	3000K	380 Lm	150 Lm	152,40 B
OU190WW47		ACIER CORTEN	ALUMINIUM	3W	3000K	380 Lm	150 Lm	152,40 B



ANTHRACITE

ACIER CORTEN







## ARTSY

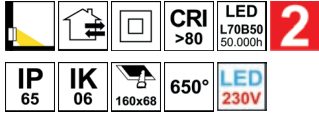

- Encastré mural extérieur rectangulaire pour balisage.
- Boîtier d'encastrement fourni.
- Ne nécessite pas de convertisseur.

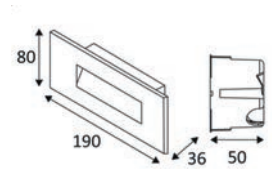

ARTSY		MATIÈRE	LED	T°	LED Lumen	System Lumen	€
OU374WW37	BLANC	VERRE	5W	3000K	480 Lm	202 Lm	128,80 B



## DEVI



- Encastré mural extérieur rectangulaire pour balisage.
- Boîtier d'encastrement fourni.
- Avec entrée et sortie de câble.
- Convertisseur non dimmable intégré dans l'appareil.

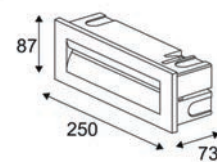
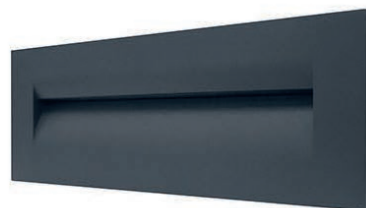

DEVI	MATIÈRE	LED	T°	LED Lumen	System Lumen	€	
OU350NW24	ANTHRACITE	ALUMINIUM	8,5W	4000K	500 Lm	189 Lm	146,30 B





## LUXI 193



- Encastré mural extérieur rectangulaire pour balisage.
- Boîtier d'encastrement fourni.
- Avec entrée et sortie de câble.
- Convertisseur non dimmable intégré dans l'appareil.

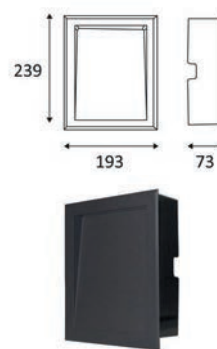

LUXI 193		MATIÈRE	LED	T°	LED Lumen	System Lumen	€
OU20424	■ ANTHRACITE	ALUMINIUM	6W	3000K	505 Lm	411 Lm	140,10 B



# INDIGO

LIGHTING

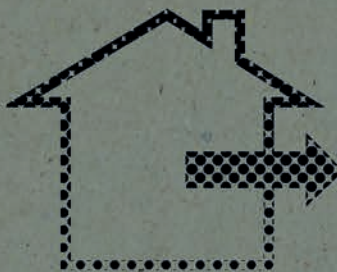

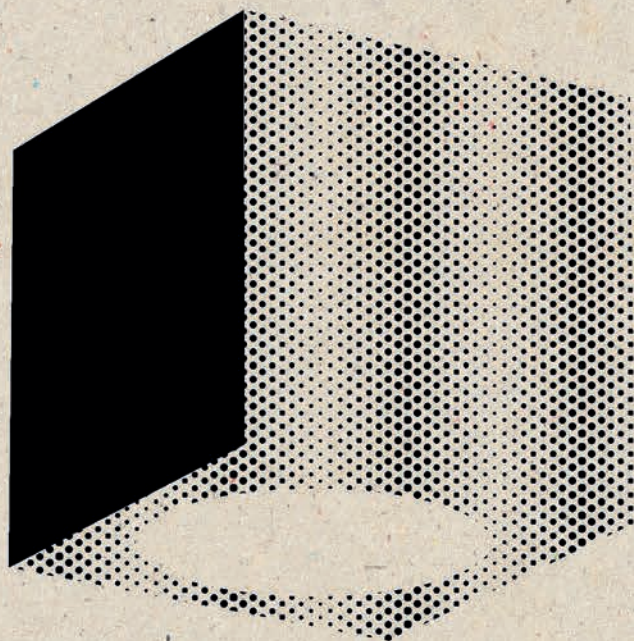

## **APPLIQUES**



### ALTO 1 GU10

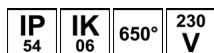

- Applique murale pour éclairage extérieur.
- Diffuseur en verre trempé clair.
- Eclairage "down".

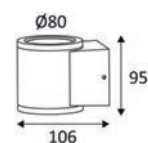

ALTO 1 GU10	MATIÈRE	SOCKET	LAMP	Watt Max	€
OU50805	■ NOIR MAT	ALUMINIUM	PAR16	35W	67,00 B

### ALTO 2 GU10

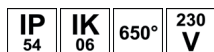

- Applique murale pour éclairage extérieur.
- Diffuseurs en verre trempé clair.
- Eclairage "up&down".

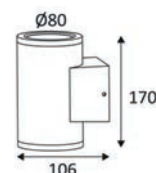

ALTO 2 GU10	MATIÈRE	SOCKET	LAMP	Watt Max	€
OU50905	■ NOIR MAT	ALUMINIUM	PAR16	2x35W	75,20 B



### ALTEA 1 GU10

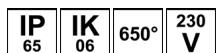

- Applique murale pour éclairage extérieur.
- Diffuseur en verre trempé clair.
- Eclairage "down".

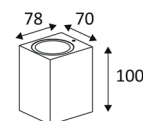

ALTEA 1 GU10	MATIÈRE	SOCKET	LAMP	Watt Max	€
OU51005  NOIR MAT	FONTE D'ALUMINIUM	GU10	PAR16	35W	75,20 B

### ALTEA 2 GU10

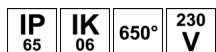

- Applique murale pour éclairage extérieur.
- Diffuseurs en verre trempé clair.
- Eclairage "up&down".
- Avec entrée et sortie de câble.

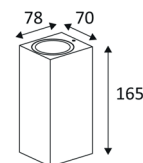

ALTEA 2 GU10	MATIÈRE	SOCKET	LAMP	Watt Max	€
OU51105  NOIR MAT	FONTE D'ALUMINIUM	GU10	PAR16	2x35W	84,50 B

## FURY S GU10

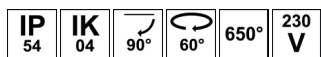

- Applique murale ou plafonnier pour éclairage extérieur.

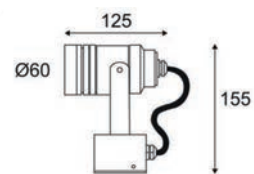

FURY S GU10		MATIÈRE	SOCKET	LAMP	Watt Max	€
OU31024	ANTHRACITE	ALUMINIUM	GU10	PAR16	35W	98,90 B







## HUGO GU10

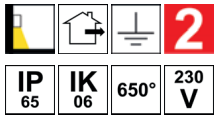

- Applique murale pour éclairage extérieur.
- Eclairage "down".

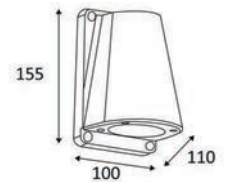

HUGO GU10		MATIÈRE	SOCKET	LAMP	Watt Max	€
BO1360A15	■ ANTHRACITE	FORTE D'ALUMINIUM	GU10	PAR16	35W	112,30 B



## KADRO E27

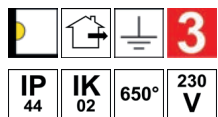

- Applique murale pour éclairage extérieur.
- Diffuseur en verre.
- Avec entrée et sortie de câble.
- Lampe E27 à commander séparément.

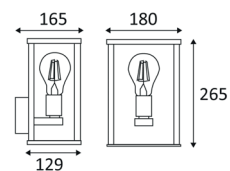

KADRO E27		MATIÈRE	SOCKET	LAMP	Watt Max	€
OU25324	■ ANTHRACITE	ALUMINIUM	E27	CLA	8W	177,20 B





## MINO W E27

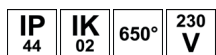

- Applique murale pour éclairage extérieur.
- Diffuseur en verre dépoli.
- Lampe E27 à commander séparément.

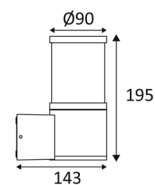

MINO W E27		MATIÈRE	SOCKET	LAMP	Watt Max	€
OU43424	ANTHRACITE	FORTE D'ALUMINIUM	E27	CLA	26W	75,20 B



### MINO P E27

DANS LA MÊME GAMME  
PAGE 458

## RONDO W E27

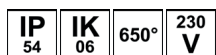

- Applique murale pour éclairage extérieur.
- Corps anthracite et diffuseur en verre clair ou opalin.
- Lampe E27 à commander séparément.

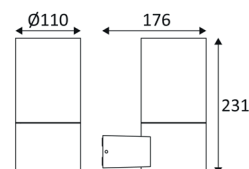

RONDO W E27		MATIÈRE	SOCKET	LAMP	Watt Max	€
OU40724	ANT. + VERRE OPALIN	FORTE D'ALUMINIUM	E27	CLA	18W	116,40 B
OU40824	ANT. + VERRE CLAIR	FORTE D'ALUMINIUM	E27	CLA	18W	116,40 B



ANT. + VERRE  
OPALIN



ANT. + VERRE CLAIR



### RONDO P E27

DANS LA MÊME GAMME  
PAGE 458

## LUXI 120 R

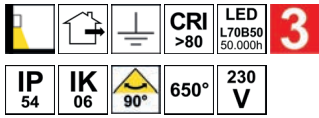

- Applique murale extérieure pour balisage.
- Convertisseur non dimmable intégré dans l'appareil.

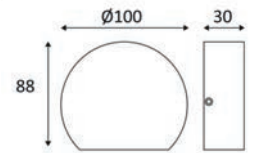

LUXI 120 R	MATIÈRE	LED	T°	LED Lumen	System Lumen	€
OU14524	ANTHRACITE	3W	3000K	180 Lm	112 Lm	89,60 B

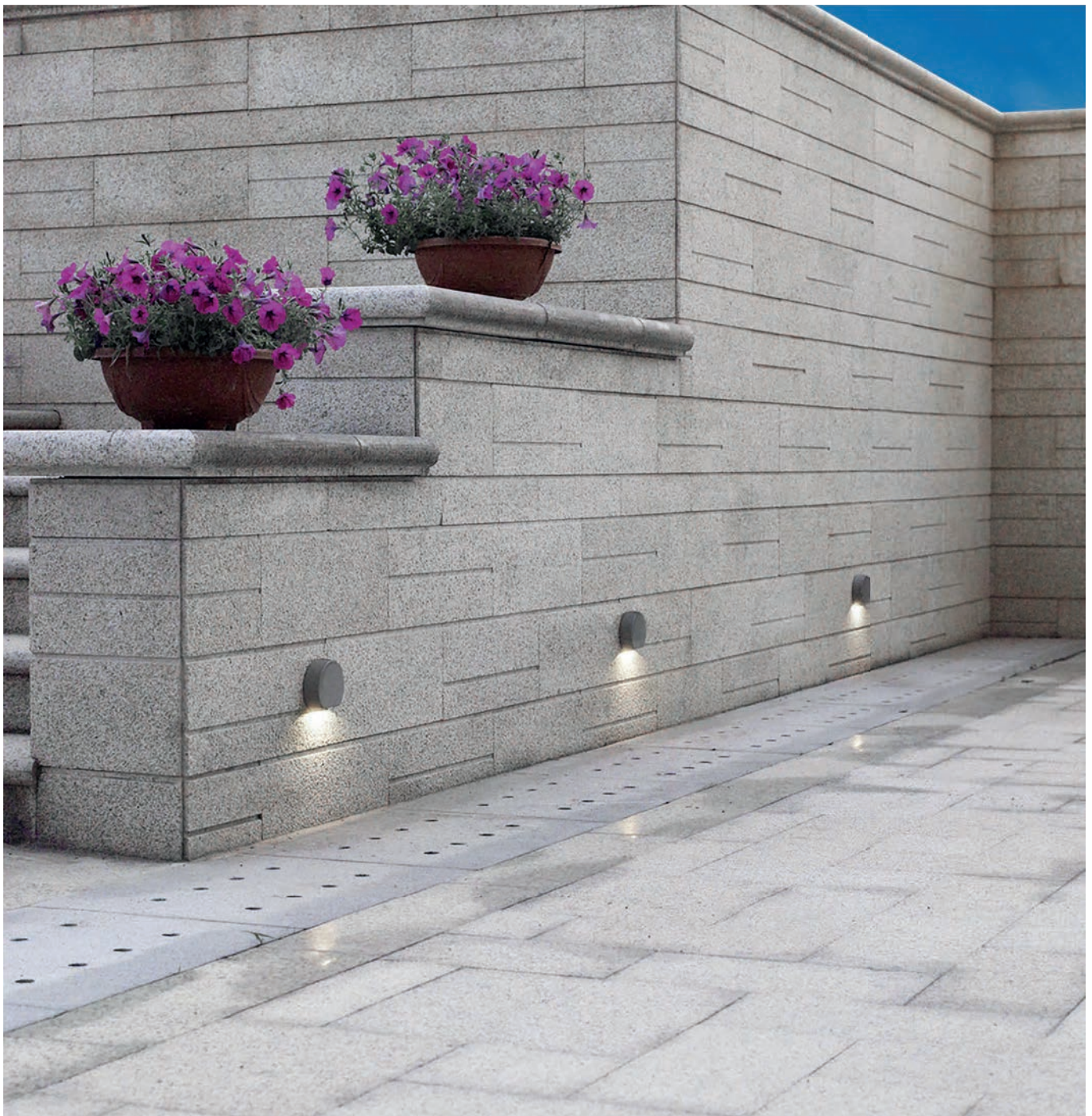



## LUXI 120 S

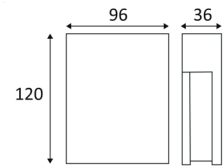
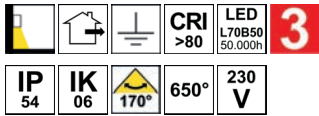

- Applique murale extérieure pour balisage.
- Diffuseur en polycarbonate.
- Convertisseur non dimmable intégré dans l'appareil.

LUXI 120 S	MATIÈRE	LED	T°	LED Lumen	System Lumen	€
OU14624	ANTHRACITE	3W	3000K	320 Lm	217 Lm	89,60 B



## ELBY R

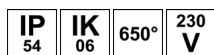

- Applique murale extérieure pour balisage.
- Convertisseur non dimmable intégré dans l'appareil.

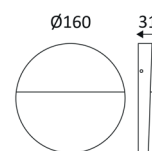

ELBY R	MATIERE	LED	T°	LED Lumen	System Lumen	€
OU364WW24	ANTHRACITE	3W	3000K	390 Lm	299 Lm	81,40 B

## ELBY S

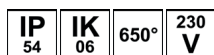

- Applique murale extérieure pour balisage.
- Convertisseur non dimmable intégré dans l'appareil.

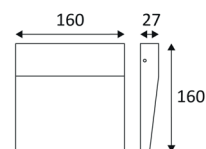

ELBY S	MATIERE	LED	T°	LED Lumen	System Lumen	€
OU365WW24	ANTHRACITE	3W	3000K	390 Lm	297 Lm	83,40 B



## COSTE 1

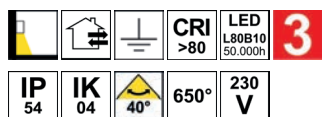

- Applique murale extérieure pour balisage.
- Convertisseur non dimmable intégré dans l'appareil.

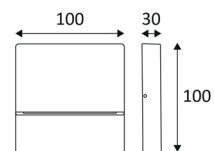

COSTE 1		MATIÈRE	LED	T°	LED Lumen	System Lumen	€	
OU513WW05		NOIR MAT	FONTE D'ALUMINIUM	4W	3000K	320 Lm	175 Lm	59,00 B
OU513WW24		ANTHRACITE	FONTE D'ALUMINIUM	4W	3000K	320 Lm	175 Lm	59,00 B



NOIR MAT



ANTHRACITE

## COSTE 2

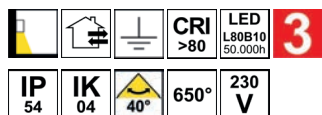

- Applique murale extérieure pour balisage.
- Avec entrée et sortie de câble.
- Convertisseur non dimmable intégré dans l'appareil.



COSTE 2		MATIÈRE	LED	T°	LED Lumen	System Lumen	€	
OU514WW05		NOIR MAT	FONTE D'ALUMINIUM	8W	3000K	910 Lm	295 Lm	102,00 B
OU514WW24		ANTHRACITE	FONTE D'ALUMINIUM	8W	3000K	910 Lm	295 Lm	102,00 B



NOIR MAT



ANTHRACITE





## ITO

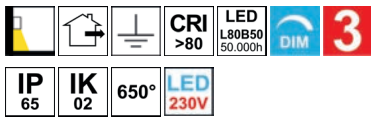

- Applique murale extérieure pour balisage.
- Ne nécessite pas de convertisseur.
- Dimmable.

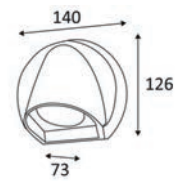

ITO	MATIÈRE	LED	T°	LED Lumen	System Lumen	€
OU340WW24	ANTHRACITE	8W	3000K	700 Lm	328 Lm	145,20 B





## WL041 IP

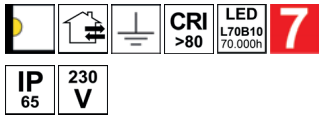

  
collingwood

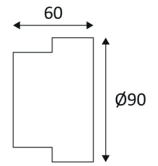

NEW



- Applique murale décorative.
- Eclairage à effet hélice.
- Convertisseur non-dimmable intégré dans l'appareil.

WL041 IP			MATIÈRE	LED	T°	LED Lumen	System Lumen	€
WL041IPWW	NEW	ARGENT	ALUMINIUM	1,6W	3000K	90 Lm	33 Lm	223,80 A
WL041IPNW	NEW	ARGENT	ALUMINIUM	1,6W	4000K	90 Lm	37 Lm	223,80 A



## WIDO

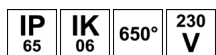

- Applique ou plafonnier décoratif extérieur.
- Effet lumineux linéaire.
- Convertisseur non dimmable intégré dans l'appareil.
- Accessoire pour montage sur surface inclinée fourni.

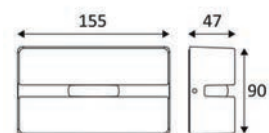

WIDO		MATIÈRE	LED	T°	LED Lumen	System Lumen	€
OU41024	■ ANTHRACITE	FORTE D'ALUMINIUM	3W	3000K	220 Lm	75 Lm	113,30 B





## FINN W

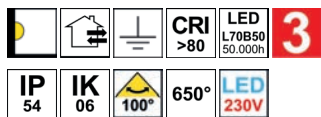

- Applique murale pour éclairage extérieur.
- Diffuseur en polycarbonate.
- Ne nécessite pas de convertisseur.

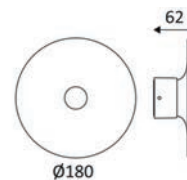

FINN W	MATÈRE	LED	T°	LED Lumen	System Lumen	€	
OU502WW05	NOIR MAT	ALUMINIUM	10W	3000K	1100 Lm	965 Lm	83,40 B



### FINN P

DANS LA MÊME GAMME  
PAGE 469







## MF02 IP

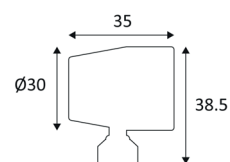
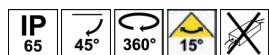
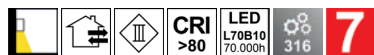



NEW



- Spot mural pour éclairage intérieur et extérieur.
- 0,15m de câble fourni.
- Base de fixation simple ou double à commander séparément.
- Convertisseur 350mA (montage à distance) à commander séparément.

ALIMENTATION(S)		Watt Max	€
PLR35015	NEW	1-5W	43,90 A
PLU35019	NEW	1-9W	50,90 A
PSIP3509W	NEW	1-9W	44,00 A
PSIP35018W	NEW	9-18W	57,70 A

MF02 IP		MATIÈRE	LED	T°	LED Lumen	System Lumen	€
MF02IP27	NEW	INOX 316	1W	2700K	80 Lm	52 Lm	111,30 A
MF02IPNW	NEW	INOX 316	1W	4000K	90 Lm	66 Lm	111,30 A

ACCESSOIRES		MATIÈRE	DESCRIPTION	L (mm)	€
WBM01	NEW	INOX 316	BASE SIMPLE RONDE 45x10mm		31,80 A
WBM02	NEW	INOX 316	BASE DOUBLE RECTANGULAIRE 84x54x13mm	84 	51,70 A

## UL010

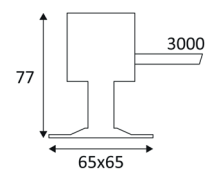
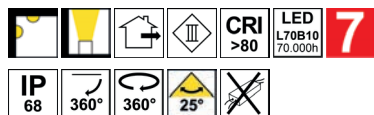

- Spot mural pour éclairage extérieur.
- Versions inox 316 pour les zones côtières.
- 3m de câble H05RN-F fourni (diamètre 6mm).
- Convertisseur 700mA (montage à distance) à commander séparément.
- Boîte de raccordement étanche à commander séparément.

ALIMENTATION(S)		Watt Max	€
PSIP70018W	NEW	2-18W	56,10 A
PSIP70036W	NEW	18-36W	73,40 A

UL010		MATIÈRE	LED	T°	LED Lumen	System Lumen	€
UL01027	NEW	INOX 316	3W	2700K	240 Lm	92 Lm	165,00 A
UL010WW	NEW	INOX 316	3W	3000K	250 Lm	95 Lm	165,00 A
UL010NW	NEW	INOX 316	3W	4000K	260 Lm	119 Lm	165,00 A
UL010A27	NEW	LAITON	3W	2700K	240 Lm	92 Lm	176,70 A
UL010AWW	NEW	LAITON	3W	3000K	250 Lm	95 Lm	176,70 A

ACCESSOIRES		DESCRIPTION	€
JB2	NEW	BOITE DE RACCORDEMENT SERIE 3 SORTIES IP68	13,60 A
JB4	NEW	BOITE DE CONNEXION SERIE AVEC GEL IP68	54,70 A
JB6	NEW	CONNECTEUR AVEC GEL IP68	29,60 A
WCR275BLACK	NEW	CABLE H05RN-F 2x0,75mm² 1m	8,80 A







## UL010 RGBW

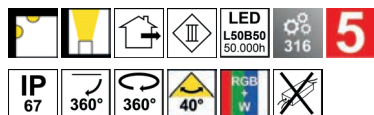

collingwood

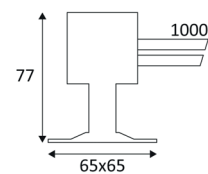

NEW

- Spot mural RGBW pour éclairage extérieur.
- Inox 316 pour les zones côtières.
- Deux longueurs d'1m de câble (diamètre 7,4mm) fournies.
- Convertisseur(s), contrôleur(s), répéteur(s) de puissance et accessoires à commander séparément (voir chapitre GESTION D'ECLAIRAGE).
- Un à six produit(s) par répéteur de puissance PR3011.
- Boîte de raccordement étanche à commander séparément.

UL010 RGBW	MATIÈRE	LED	T°	System Lumen	L (mm)	€
UL010RGBW	<b>NEW</b> INOX 316	4x1,1W	RGB+W (4000K)	50 Lm (4000K)	65	363,40 A

ACCESSOIRES	DESCRIPTION	€
C100924	<b>NEW</b> CONTROLEUR LED RGB(W)	183,80 A
PR3011	<b>NEW</b> REPETEUR DE PUISSANCE RGB(W) 350mA 4x8,4W	108,20 A
JB7	<b>NEW</b> CONNECTEUR A VISSER 5 BORNES IP68	42,60 A
CR575RGBW	<b>NEW</b> CABLE PVC 5x0,75mm² RGBW 1m	5,00 A



## UL030

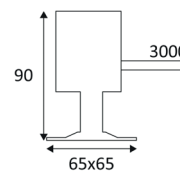

- Spot mural pour éclairage extérieur.
- Versions inox 316 pour les zones côtières.
- 3m de câble H05RN-F fourni (diamètre 6mm).
- Convertisseur 700mA (montage à distance) à commander séparément.
- Boîte de raccordement étanche à commander séparément.

ALIMENTATION(S)		Watt Max	€	
PSIP70018W	NEW	2-18W	56,10	A
PSIP70036W	NEW	18-36W	73,40	A

UL030			MATIÈRE	LED	T°	System Lumen	α	€	
UL030DNBX27	NEW	INOX 316	INOX 316	4,6W	2700K	470 Lm	12°	297,20	A
UL030DNBX30	NEW	INOX 316	INOX 316	4,6W	3000K	480 Lm	12°	297,20	A
UL030DNBX40	NEW	INOX 316	INOX 316	4,6W	4000K	490 Lm	12°	297,20	A
UL030ANAX27	NEW	LAITON	LAITON	4,6W	2700K	470 Lm	12°	317,30	A
UL030ANAX30	NEW	LAITON	LAITON	4,6W	3000K	480 Lm	12°	317,30	A
UL030DWBX27	NEW	INOX 316	INOX 316	4,6W	2700K	470 Lm	40°	297,20	A
UL030DWBX30	NEW	INOX 316	INOX 316	4,6W	3000K	480 Lm	40°	297,20	A
UL030DWBX40	NEW	INOX 316	INOX 316	4,6W	4000K	490 Lm	40°	297,20	A
UL030BWBX27	NEW	NOIR	ALUMINIUM	4,6W	2700K	470 Lm	40°	181,80	A
UL030BWBX30	NEW	NOIR	ALUMINIUM	4,6W	3000K	480 Lm	40°	181,80	A
UL030AWAX27	NEW	LAITON	LAITON	4,6W	2700K	470 Lm	40°	317,30	A
UL030AWAX30	NEW	LAITON	LAITON	4,6W	3000K	480 Lm	40°	317,30	A

ACCESSOIRES	DESCRIPTION	€	
JB2	NEW BOITE DE RACCORDEMENT SERIE 3 SORTIES IP68	13,60	A
JB4	NEW BOITE DE CONNEXION SERIE AVEC GEL IP68	54,70	A
JB6	NEW CONNECTEUR AVEC GEL IP68	29,60	A
WCR275BLACK	NEW CABLE H05RN-F 2x0,75mm² 1m	8,80	A



INOX 316



LAITON



NOIR



## UL030 RGBW

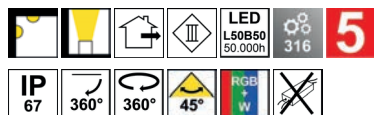

collingwood

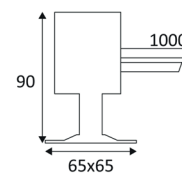

NEW

- Spot mural RGBW pour éclairage extérieur.
- Inox 316 pour les zones côtières.
- Deux longueurs d'1m de câble (diamètre 7,4mm) fournies.
- Convertisseur(s), contrôleur(s), répéteur(s) de puissance et accessoires à commander séparément (voir chapitre GESTION D'ECLAIRAGE).
- Un à deux produit(s) par répéteur de puissance PR3011.
- Boîte de raccordement étanche à commander séparément.

UL030 RGBW	MATIÈRE	LED	T°	System Lumen	L (mm)	€
UL030RGBW	<b>NEW</b> INOX 316	4x3W	RGB+W (4000K)	177 Lm (4000K)	65	499,50 A

ACCESSOIRES	DESCRIPTION	€
C100924	<b>NEW</b> CONTROLEUR LED RGB(W)	183,80 A
PR3011	<b>NEW</b> REPETEUR DE PUISSANCE RGB(W) 350mA 4x8,4W	108,20 A
JB7	<b>NEW</b> CONNECTEUR A VISSER 5 BORNES IP68	42,60 A
CR575RGBW	<b>NEW</b> CABLE PVC 5x0,75mm² RGBW 1m	5,00 A



## WL220 MAINS

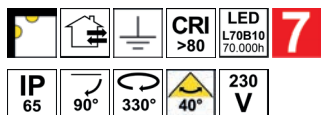
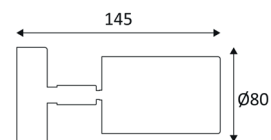

- Applique murale pour éclairage extérieur.
- Versions inox 316 pour les zones côtières.
- Convertisseur non-dimmable intégré dans l'appareil.

WL220 MAINS		MATIÈRE	LED	T°	System Lumen	€
WL220BWB27	NEW NOIR	ALUMINIUM	5,7W	2700K	515 Lm	282,50 A
WL220BWB30	NEW NOIR	ALUMINIUM	5,7W	3000K	520 Lm	282,50 A
WL220DWB27	NEW INOX 316	INOX 316	5,7W	2700K	515 Lm	310,10 A
WL220DWB30	NEW INOX 316	INOX 316	5,7W	3000K	520 Lm	310,10 A
WL220ZWB27	NEW BRONZE	ALUMINIUM	5,7W	2700K	515 Lm	282,50 A
WL220ZWB30	NEW BRONZE	ALUMINIUM	5,7W	3000K	520 Lm	282,50 A
WL220CWB27	NEW CUIVRE	CUIVRE	5,7W	2700K	515 Lm	496,80 A

ACCESSOIRES		MATIÈRE	DESCRIPTION	€
GH220B	NEW NOIR	ALUMINIUM	CYLINDRE ASYMETRIQUE	59,60 A
GH220D	NEW INOX 316	INOX 316	CYLINDRE ASYMETRIQUE	91,80 A
GH220Z	NEW BRONZE	ALUMINIUM	CYLINDRE ASYMETRIQUE	59,60 A
GS220B	NEW NOIR	ALUMINIUM	CYLINDRE BASSE LUMINANCE	59,60 A
GS220D	NEW INOX 316	INOX 316	CYLINDRE BASSE LUMINANCE	91,80 A
GS220Z	NEW BRONZE	ALUMINIUM	CYLINDRE BASSE LUMINANCE	59,60 A



**SL220 MAINS**  
DANS LA MÊME GAMME  
PAGE 449



NOIR



INOX 316



BRONZE



CUIVRE





## WL075

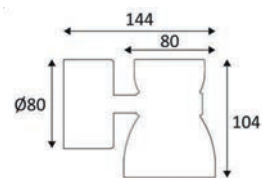

- Applique murale pour éclairage extérieur.
- Convertisseur non-dimmable intégré dans l'appareil.

WL075			MATIÈRE	LED	T°	System Lumen	€
WL075BNBM27	NEW	NOIR	ALUMINIUM	5,7W	2700K	515 Lm	427,20 A
WL075BNBM30	NEW	NOIR	ALUMINIUM	5,7W	3000K	520 Lm	427,20 A
WL075SNBM27	NEW	ARGENT	ALUMINIUM	5,7W	2700K	515 Lm	427,20 A
WL075SNBM30	NEW	ARGENT	ALUMINIUM	5,7W	3000K	520 Lm	427,20 A
WL075ZNBM27	NEW	BRONZE	ALUMINIUM	5,7W	2700K	515 Lm	427,20 A
WL075ZNBM30	NEW	BRONZE	ALUMINIUM	5,7W	3000K	520 Lm	427,20 A



NOIR



ARGENT



BRONZE



## GUNZY S

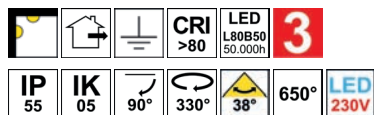

- Applique murale ou plafonnier pour éclairage extérieur.
- Base apparente avec entrée et sortie de câble.
- Ne nécessite pas de convertisseur.
- Non dimmable.

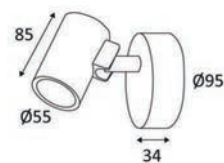

GUNZY S	MATÈRE	LED	T°	LED Lumen	System Lumen	€
OU18524	ANTHRACITE	8W	3000K	760 Lm	463 Lm	180,30 B



### GUNZY

DANS LA MÊME GAMME  
PAGE 442

## GUNZY 2 S

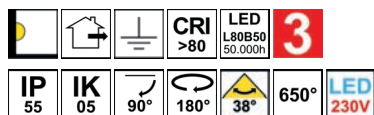

- Applique murale pour éclairage extérieur.
- Base apparente avec entrée et sortie de câble.
- Ne nécessite pas de convertisseur.
- Non dimmable.

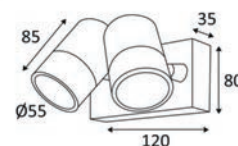

GUNZY 2 S	MATÈRE	LED	T°	LED Lumen	System Lumen	€
OU18624	ANTHRACITE	2x8W	3000K	2x760 Lm	2x463 Lm	335,80 B



### GUNZY 2 P

DANS LA MÊME GAMME  
PAGE 443



## ARCOLE

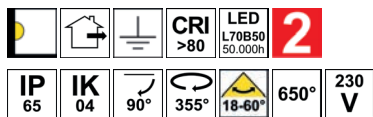

- Applique murale pour éclairage extérieur.
- Base apparente avec entrée et sortie de câble.
- Faisceau ajustable de 18° à 60°.
- Convertisseur non dimmable intégré dans l'appareil.



ARCOLE	MATIÈRE	LED	T°	LED Lumen	System Lumen	€
OU375WW24	ANTHRACITE	8W	3000K	800 Lm	456 Lm	211,20 B



## LUXI 100 S

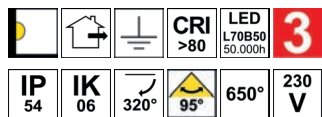

- Applique murale pour éclairage extérieur.
- Convertisseur non dimmable intégré dans l'appareil.

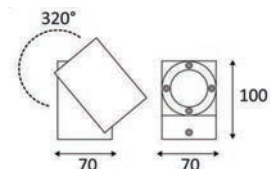

LUXI 100 S		MATIÈRE	LED	T°	LED Lumen	System Lumen	€
OU14324	■ ANTHRACITE	FORTE D'ALUMINIUM	7W	3000K	660 Lm	465 Lm	153,50 B



### LUXI 100 S P

DANS LA MÊME GAMME  
PAGE 472







## BENS W



- Applique murale pour éclairage extérieur.
- Convertisseur non dimmable intégré dans l'appareil.

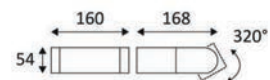

BENS W	MATIÈRE	LED	T°	LED Lumen	System Lumen	€
OU360WW24	ANTHRACITE	6W	3000K	600 Lm	433 Lm	150,40 B



### BENS P

DANS LA MÊME GAMME  
PAGE 474



NEW

## BRIKPRO 1

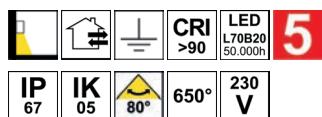

- Applique murale pour éclairage extérieur.
- Diffuseur en verre opalin.
- Eclairage direct.
- Convertisseur non dimmable intégré dans l'appareil.

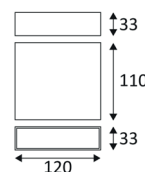

BRIKPRO 1		MATIÈRE	LED	T°	LED Lumen	System Lumen	€	
BP12/1D/3K/A	NEW	ANTHRACITE	FONTE D'ALUMINIUM	7W	3000K	870 Lm	695 Lm	99,00 B
BP12/1D/3K/G	NEW	GRIS MAT	FONTE D'ALUMINIUM	7W	3000K	870 Lm	695 Lm	99,00 B
BP12/1D/3K/W	NEW	BLANC MAT	FONTE D'ALUMINIUM	7W	3000K	870 Lm	695 Lm	99,00 B
BP12/1D/3K/BR	NEW	ACIER CORTEN	FONTE D'ALUMINIUM	7W	3000K	870 Lm	695 Lm	103,00 B



ANTHRACITE



GRIS MAT



BLANC MAT



ACIER CORTEN

NEW

## BRIKPRO 2

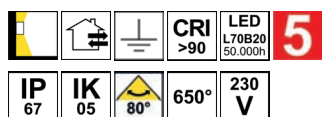

- Applique murale pour éclairage extérieur.
- Diffuseurs en verre opalin.
- Eclairage direct/indirect.
- Convertisseur non dimmable intégré dans l'appareil.

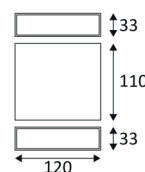

BRIKPRO 2		MATIÈRE	LED	T°	LED Lumen	System Lumen	€	
BP12/2D/3K/A	NEW	ANTHRACITE	FONTE D'ALUMINIUM	2x7W	3000K	2x870 Lm	2x695 Lm	117,00 B
BP12/2D/3K/G	NEW	GRIS MAT	FONTE D'ALUMINIUM	2x7W	3000K	2x870 Lm	2x695 Lm	117,00 B
BP12/2D/3K/W	NEW	BLANC MAT	FONTE D'ALUMINIUM	2x7W	3000K	2x870 Lm	2x695 Lm	117,00 B
BP12/2D/3K/BR	NEW	ACIER CORTEN	FONTE D'ALUMINIUM	2x7W	3000K	2x870 Lm	2x695 Lm	122,00 B



ANTHRACITE



GRIS MAT



BLANC MAT



ACIER CORTEN



NEW

## BRIKPRO 1 A

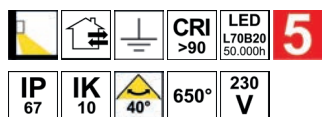

- Applique murale pour éclairage extérieur.
- Diffuseur en verre sérigraphié noir.
- Faisceau asymétrique.
- Eclairage direct.
- Convertisseur non dimmable intégré dans l'appareil.

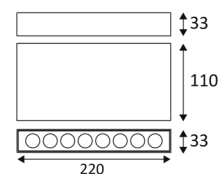
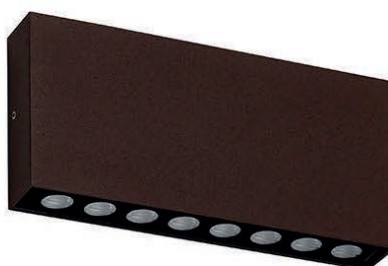

BRIKPRO 1 A		MATIÈRE	LED	T°	LED Lumen	System Lumen	€	
BP22/1C/3K/A	NEW	ANTHRACITE	FONTE D'ALUMINIUM	14W	3000K	1300 Lm	940 Lm	219,00 B
BP22/1C/3K/G	NEW	GRIS MAT	FONTE D'ALUMINIUM	14W	3000K	1300 Lm	940 Lm	219,00 B
BP22/1C/3K/W	NEW	BLANC MAT	FONTE D'ALUMINIUM	14W	3000K	1300 Lm	940 Lm	219,00 B
BP22/1C/3K/BR	NEW	ACIER CORTEN	FONTE D'ALUMINIUM	14W	3000K	1300 Lm	940 Lm	225,00 B



ANTHRACITE      GRIS MAT      BLANC MAT      ACIER CORTEN

NEW

## BRIKPRO 2 A

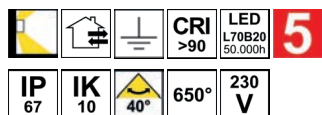

- Applique murale pour éclairage extérieur.
- Diffuseurs en verre sérigraphié noir.
- Faisceaux asymétriques.
- Eclairage direct/indirect.
- Convertisseur non dimmable intégré dans l'appareil.

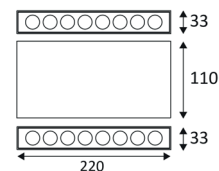
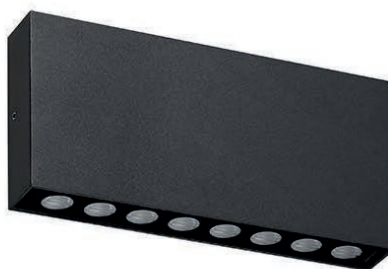

BRIKPRO 2 A		MATIÈRE	LED	T°	LED Lumen	System Lumen	€	
BP22/2C/3K/A	NEW	ANTHRACITE	FONTE D'ALUMINIUM	2x14W	3000K	2x1300 Lm	2x940 Lm	246,00 B
BP22/2C/3K/G	NEW	GRIS MAT	FONTE D'ALUMINIUM	2x14W	3000K	2x1300 Lm	2x940 Lm	246,00 B
BP22/2C/3K/W	NEW	BLANC MAT	FONTE D'ALUMINIUM	2x14W	3000K	2x1300 Lm	2x940 Lm	246,00 B
BP22/2C/3K/BR	NEW	ACIER CORTEN	FONTE D'ALUMINIUM	2x14W	3000K	2x1300 Lm	2x940 Lm	252,00 B



ANTHRACITE      GRIS MAT      BLANC MAT      ACIER CORTEN



## ONEO A

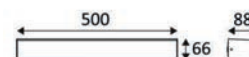
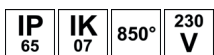

- Applique murale pour éclairage extérieur.
- Eclairage "down".
- Faisceau asymétrique.
- Avec entrée et sortie de câble.
- Convertisseur non dimmable intégré dans l'appareil.



ONEO A	MATIÈRE	LED	T°	LED Lumen	System Lumen	€
OU453WW24	ANTHRACITE	15W	3000K	1350 Lm	967 Lm	233,80 B

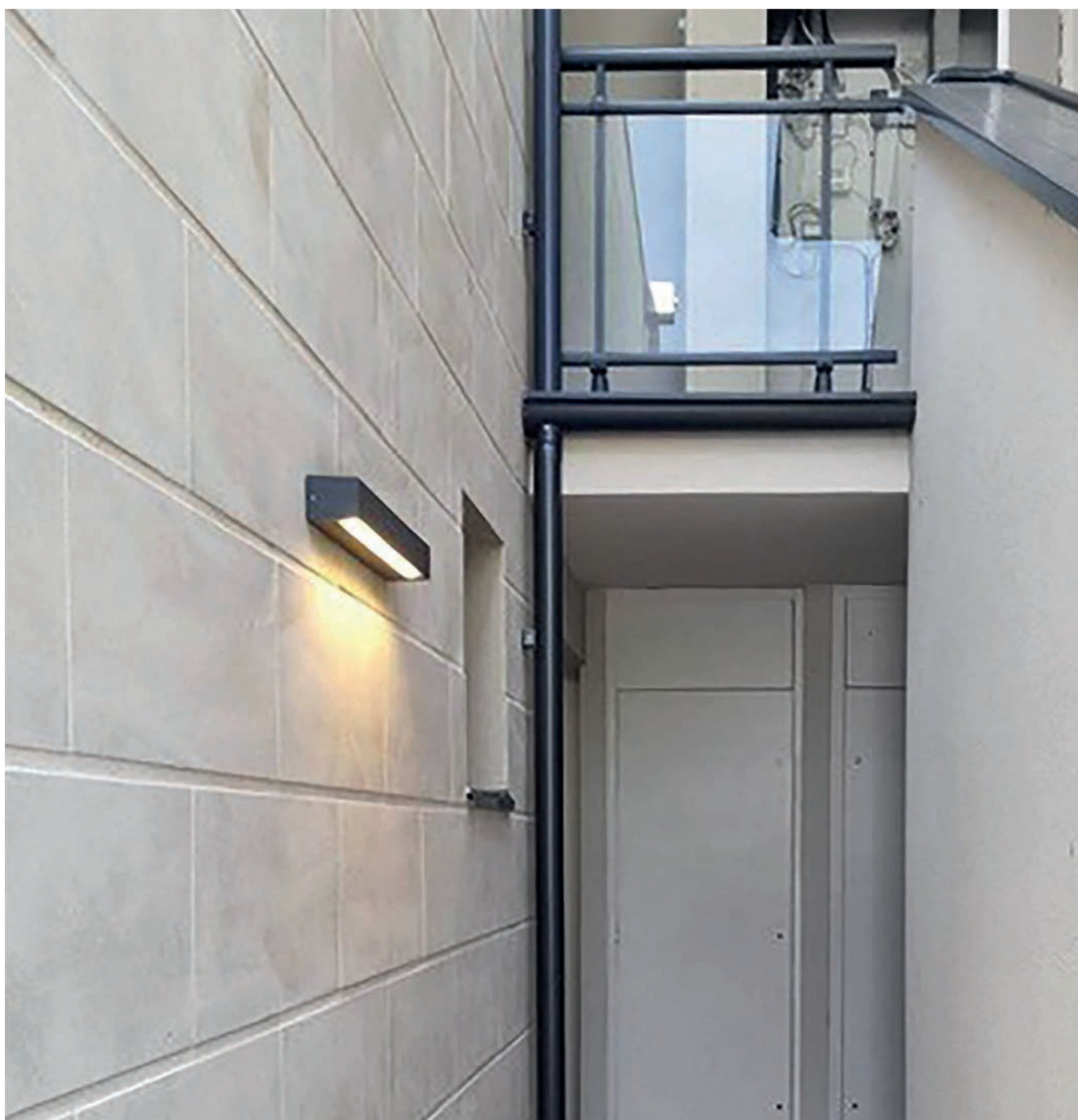



## HARRY A

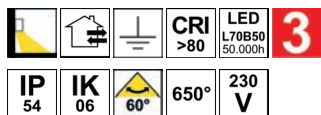

- Applique murale pour éclairage extérieur.
- Eclairage "down".
- Faisceau asymétrique.
- Avec entrée et sortie de câble.
- Convertisseur non dimmable intégré dans l'appareil.

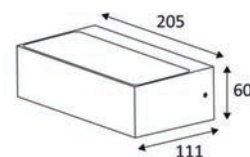

HARRY A		MATIÈRE	LED	T°	LED Lumen	System Lumen	€
OU501WW05	■ NOIR MAT	ALUMINIUM	16W	3000K	1370 Lm	1005 Lm	203,90 B
OU501NW05	■ NOIR MAT	ALUMINIUM	16W	4000K	1370 Lm	1125 Lm	203,90 B

## BALTI A

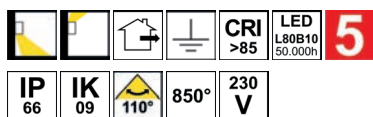

- Applique murale pour éclairage extérieur.
- Eclairage "up" ou "down".
- Faisceau asymétrique.
- Convertisseur non dimmable intégré dans l'appareil.

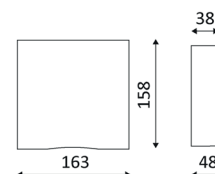

BALTI A		MATIÈRE	LED	T°	LED Lumen	System Lumen	€
OU27704	■ BLANC	FONTE D'ALUMINIUM	26W	3000K	3400 Lm	2551 Lm	401,70 B



## WL060

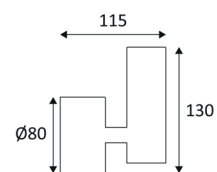

- Applique murale pour éclairage extérieur.
- Bidirectionnel : éclairage supérieur diffus et inférieur direct.
- Convertisseur non-dimmable intégré dans l'appareil.

WL060			MATIÈRE	LED	T°	LED Lumen	System Lumen	€	
WL16027	NEW	NOIR	ALUMINIUM	2,6W	2700K	80 Lm	56 Lm	299,00	A
WL160WW	NEW	NOIR	ALUMINIUM	2,6W	3000K	90 Lm	58 Lm	299,00	A
WL160NW	NEW	NOIR	ALUMINIUM	2,6W	4000K	90 Lm	82 Lm	299,00	A
WL060WW	NEW	ARGENT	ALUMINIUM	2,6W	3000K	90 Lm	58 Lm	268,00	A
WL060NW	NEW	ARGENT	ALUMINIUM	2,6W	4000K	90 Lm	82 Lm	268,00	A



NOIR



ARGENT







## LUXI 139

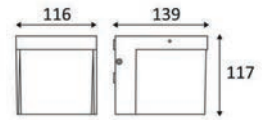
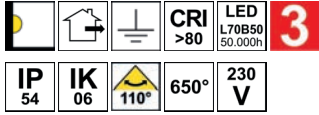

- Applique murale pour éclairage extérieur.
- Diffuseur en polycarbonate opalin.
- Convertisseur non dimmable intégré dans l'appareil.

LUXI 139		MATIÈRE	LED	T°	LED Lumen	System Lumen	€
OU13512	GRIS ARGENT	FORTE D'ALUMINIUM	3,8W	3000K	400 Lm	316 Lm	93,70 B
OU13524	ANTHRACITE	FORTE D'ALUMINIUM	3,8W	3000K	400 Lm	316 Lm	93,70 B



GRIS ARGENT

ANTHRACITE



## LUXI 45

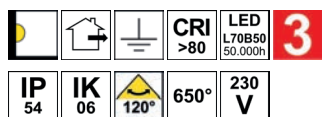

- Applique murale pour éclairage extérieur.
- Diffuseur en polycarbonate opalin.
- Convertisseur non dimmable intégré dans l'appareil.

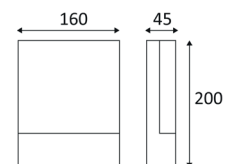

LUXI 45	MATIÈRE	LED	T°	LED Lumen	System Lumen	€	
OU20624	ANTHRACITE	ALUMINIUM	6W	3000K	660 Lm	555 Lm	141,10 B
OU20630	BLANC	ALUMINIUM	6W	3000K	660 Lm	555 Lm	141,10 B



ANTHRACITE



BLANC

## LUXI 45 SENSOR

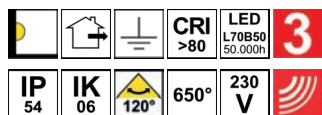

- Applique murale pour éclairage extérieur.
- Avec détecteur IR 120°, zone de détection réglable max. 6m.
- Diffuseur en polycarbonate opalin.
- Convertisseur non dimmable intégré dans l'appareil.

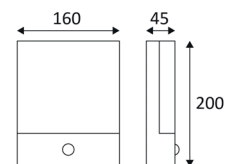

LUXI 45 SENSOR	MATIÈRE	LED	T°	LED Lumen	System Lumen	€	
OU359WW24	ANTHRACITE	ALUMINIUM	6W	3000K	660 Lm	555 Lm	167,90 B





## LUXI 175 SENSOR

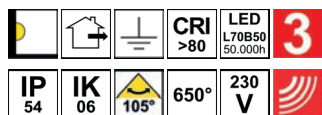

- Applique murale pour éclairage extérieur.
- Avec détecteur HF 120°, zone de détection réglable max. 8m.
- Diffuseur en polycarbonate opalin.
- Convertisseur non dimmable intégré dans l'appareil.

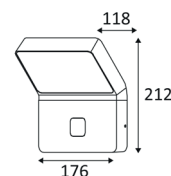

LUXI 175 SENSOR	MATIERE	LED	T°	LED Lumen	System Lumen	€
OU323WW24	ANTHRACITE	ALUMINIUM	9W	3000K	1260 Lm	760 Lm 218,00 B
OU323WW30	BLANC	ALUMINIUM	9W	3000K	1260 Lm	950 Lm 218,00 B
OU323NW24	ANTHRACITE	ALUMINIUM	9W	4000K	1300 Lm	785 Lm 218,00 B
OU323NW30	BLANC	ALUMINIUM	9W	4000K	1300 Lm	980 Lm 218,00 B



ANTHRACITE



BLANC



**LUXI 175 SENSOR P**  
DANS LA MÊME GAMME  
PAGE 478



## OPAL

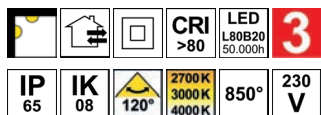

- Applique murale ou plafonnier pour éclairage extérieur.
- 2700K, 3000K ou 4000K au choix via un interrupteur dans le luminaire.
- Diffuseur en polycarbonate opalin.
- Avec entrée et sortie de câble.
- Convertisseur non dimmable intégré dans l'appareil.

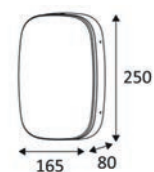

OPAL	MATIÈRE	LED	T°	LED Lumen	System Lumen	€
OU49305	■ NOIR MAT	ALUMINIUM	18W	2700-3000-4000K	2800 Lm (4000K)	1755 Lm (4000K) 155,50 B



## EDGY

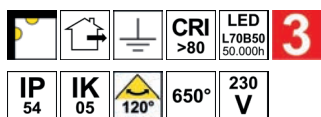

- Applique murale ou plafonnier pour éclairage extérieur.
- Diffuseur en polycarbonate opalin.
- Avec entrée et sortie de câble.
- Convertisseur non dimmable intégré dans l'appareil.

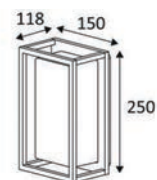

EDGY	MATIÈRE	LED	T°	LED Lumen	System Lumen	€
OU467WW24	ANTHRACITE	15W	3000K	1730 Lm	950 Lm	152,40 B





## LANTERN

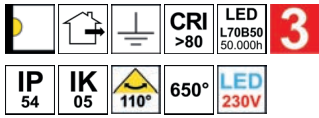

- Applique murale pour éclairage extérieur.
- Diffuseur en polycarbonate opalin.
- Ne nécessite pas de convertisseur.
- Non dimmable.



LANTERN	MATIÈRE	LED	T°	LED Lumen	System Lumen	€
OU344WW24	ANTHRACITE	18W	3000K	1500 Lm	847 Lm	128,80 B



NEW

## MC010 S

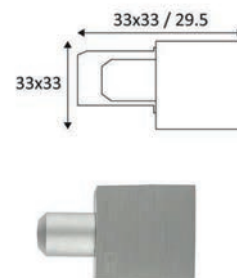
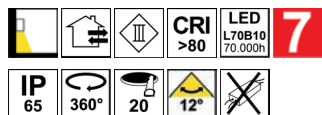

- Applique murale semi-encastrée pour éclairage intérieur et extérieur.
- Eclairage direct.
- 0,15m de câble fourni.
- Convertisseur 350mA (montage à distance) à commander séparément.

ALIMENTATION(S)		Watt Max	€
PLR35015	NEW	1-5W	43,90 A
PLU35019	NEW	1-9W	50,90 A
PSIP3509W	NEW	1-9W	44,00 A
PSIP35018W	NEW	9-18W	57,70 A

MC010 S		MATIÈRE	LED	T°	LED Lumen	System Lumen	€	
MC010S27	NEW	ARGENT	ALUMINIUM	1W	2700K	80 Lm	53 Lm	112,20 A
MC010S27	NEW	ARGENT	ALUMINIUM	1W	3000K	90 Lm	55 Lm	112,20 A

NEW

## MC020 S

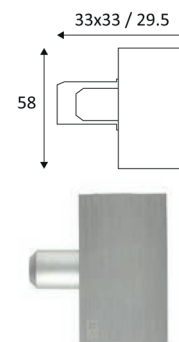
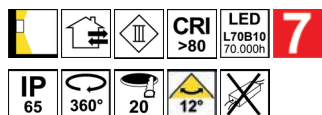

- Applique murale semi-encastrée pour éclairage intérieur et extérieur.
- Eclairage direct/indirect.
- 0,15m de câble fourni.
- Convertisseur 350mA (montage à distance) à commander séparément.

ALIMENTATION(S)		Watt Max	€
PLR35015	NEW	1-5W	43,90 A
PLU35019	NEW	1-9W	50,90 A
PSIP3509W	NEW	1-9W	44,00 A
PSIP35018W	NEW	9-18W	57,70 A

MC020 S		MATIÈRE	LED	T°	LED Lumen	System Lumen	L (mm)	€	
MC020S27	NEW	ARGENT	ALUMINIUM	2W	2700K	160 Lm	107 Lm	90	171,60 A





## ALMA R

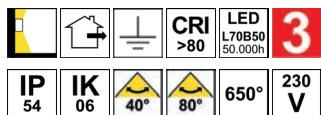

- Applique murale pour éclairage extérieur.
- Eclairage "up&down".
- Convertisseur non dimmable intégré dans l'appareil.



ALMA R	MATIÈRE	LED	T°	LED Lumen	System Lumen	α	€
OU431WW24	ANTHRACITE	6W	3000K	200 Lm	135 Lm	40° / 80°	75,20 B



## ALMA S

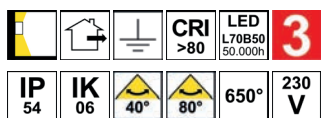

- Applique murale pour éclairage extérieur.
- Eclairage "up&down".
- Convertisseur non dimmable intégré dans l'appareil.

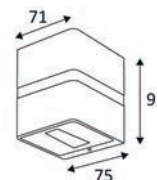

ALMA S	MATIÈRE	LED	T°	LED Lumen	System Lumen	α	€
OU387WW24	ANTHRACITE	6W	3000K	200 Lm	135 Lm	40° / 80°	78,30 B

## KOS 1 S



- Applique murale pour éclairage extérieur.
- Diffuseur en verre.
- Eclairage "up" ou "down".
- Avec entrée et sortie de câble.
- Convertisseur non dimmable intégré dans l'appareil.

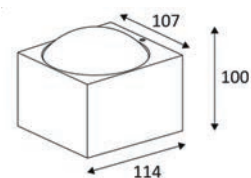

KOS 1 S	MATIÈRE	LED	T°	LED Lumen	System Lumen	€	
OU477WW24	ANTHRACITE	FONTE D'ALUMINIUM	6W	3000K	750 Lm	675 Lm	185,40 B

## KOS 2 S



- Applique murale pour éclairage extérieur.
- Diffuseurs en verre.
- Eclairage "up&down".
- Avec entrée et sortie de câble.
- Convertisseur non dimmable intégré dans l'appareil.

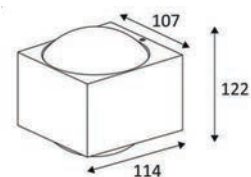

KOS 2 S	MATIÈRE	LED	T°	LED Lumen	System Lumen	€	
OU478WW24	ANTHRACITE	FONTE D'ALUMINIUM	2x6W	3000K	2x685 Lm	2x575 Lm	234,80 B

## KOS 2 R



- Applique murale pour éclairage extérieur.
- Diffuseurs en verre.
- Eclairage "up&down".
- Avec entrée et sortie de câble.
- Convertisseur non dimmable intégré dans l'appareil.

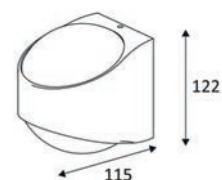

KOS 2 R	MATIÈRE	LED	T°	LED Lumen	System Lumen	€	
OU479WW24	ANTHRACITE	FONTE D'ALUMINIUM	2x6W	3000K	2x685 Lm	2x575 Lm	224,50 B



## KOPA

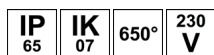

- Applique murale pour éclairage extérieur.
- Eclairage "up&down".
- Convertisseur non dimmable intégré dans l'appareil.

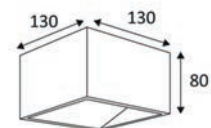

KOPA	MATIÈRE	LED	T°	LED Lumen	System Lumen	€	
OU438WW24	ANTHRACITE	FONTE D'ALUMINIUM	9W	3000K	695 Lm	620 Lm	252,40 B
ACCESSOIRES	MATIÈRE	DESCRIPTION	€				
OU43924	ANTHRACITE	ALUMINIUM	ACCESSOIRE LAME DE LUMIERE			37,10 B	

## KUBO



- Applique murale pour éclairage extérieur.
- Eclairage "up&down".
- Convertisseur non dimmable intégré dans l'appareil.

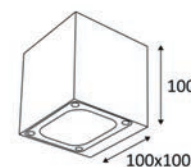

KUBO	MATIÈRE	LED	T°	LED Lumen	System Lumen	€	
OU334WW24	ANTHRACITE	FONTE D'ALUMINIUM	2x6W	3000K	2x500 Lm	2x387 Lm	131,80 B



## DANI



- Applique murale pour éclairage extérieur.
- Base apparente avec entrée et sortie de câble.
- Eclairage "up&down".
- Convertisseur non dimmable intégré dans l'appareil.

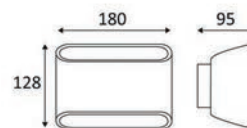

DANI	MATÉRIE	LED	T°	LED Lumen	System Lumen	€	
OU15024	ANTHRACITE	FONTE D'ALUMINIUM	2x5W	3000K	2x500 Lm	2x296 Lm	287,40 B

## POLO

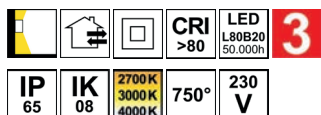

- Applique murale pour éclairage extérieur.
- 2700K, 3000K ou 4000K au choix via un interrupteur dans le luminaire.
- Eclairage "up&down".
- Avec entrée et sortie de câble.
- Convertisseur non dimmable intégré dans l'appareil.

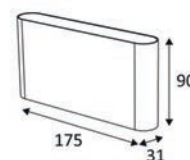

POLO	MATÉRIE	LED	T°	LED Lumen	System Lumen	€	
OU49505	NOIR MAT	ALUMINIUM	2x5W	2700-3000-4000K	2x600 Lm (4000K)	2x520 Lm (4000K)	97,90 B
OU49530	BLANC MAT	ALUMINIUM	2x5W	2700-3000-4000K	2x600 Lm (4000K)	2x555 Lm (4000K)	97,90 B



NOIR MAT



BLANC MAT



## NORA

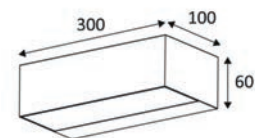
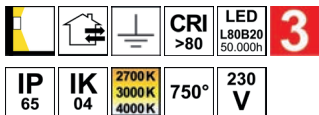

- Applique murale pour éclairage extérieur.
- 2700K, 3000K ou 4000K au choix via un interrupteur dans le luminaire.
- Diffuseurs en verre trempé dépoli.
- Eclairage "up&down".
- Avec entrée et sortie de câble.
- Convertisseur non dimmable intégré dans l'appareil.

NORA	MATÈRE	LED	T°	LED Lumen	System Lumen	€	
OU49205	NOIR MAT	ALUMINIUM	15W	2700-3000-4000K	2100 Lm (4000K)	1070 Lm (4000K)	152,40 B

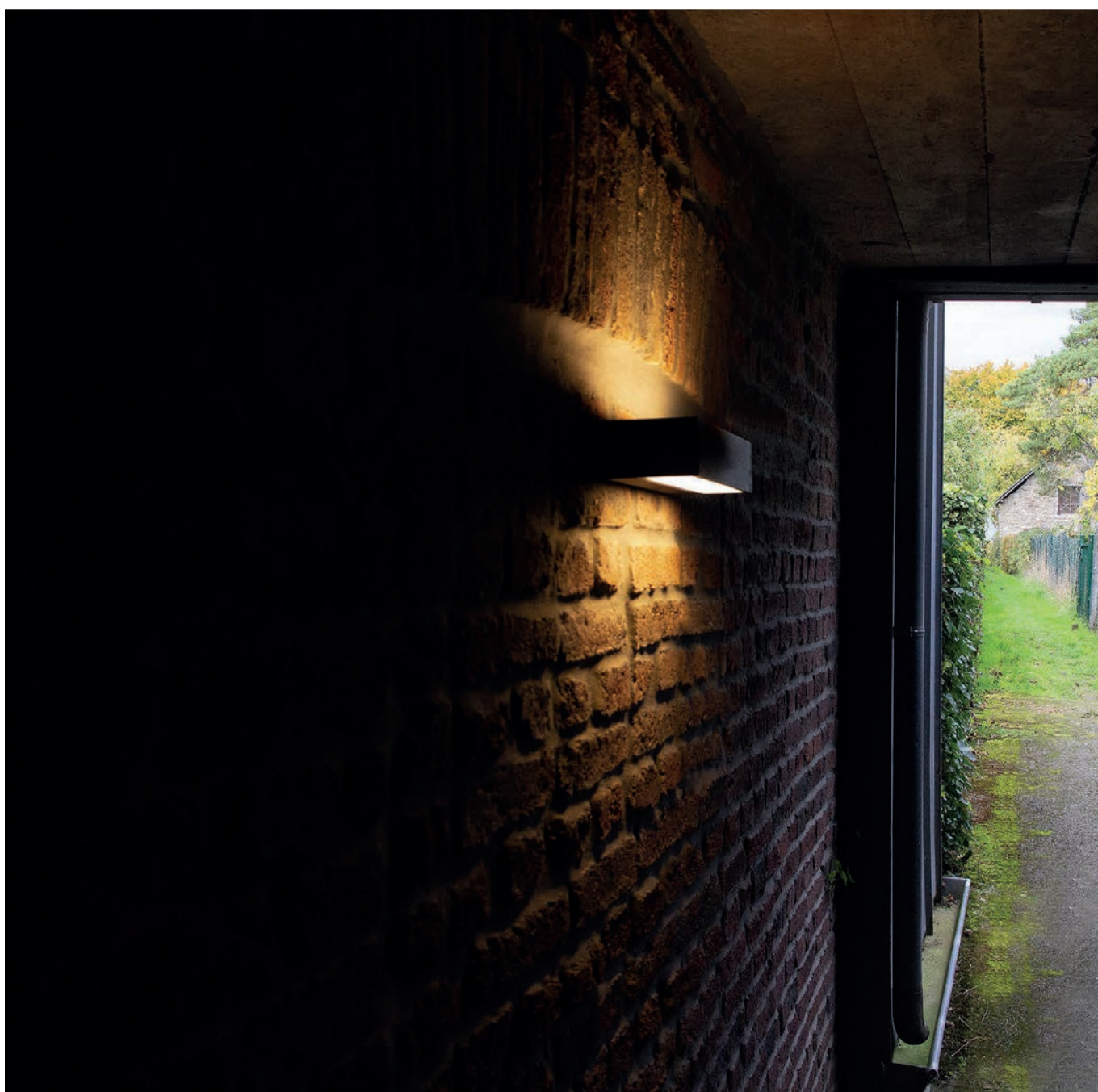





## LUXI 95

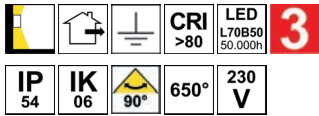

- Applique murale pour éclairage extérieur.
- Eclairage "up&down".
- Convertisseur non dimmable intégré dans l'appareil.

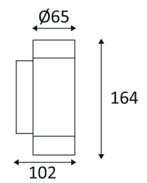

LUXI 95		MATIÈRE	LED	T°	LED Lumen	System Lumen	€	
OU14424		ANTHRACITE	FONTA D'ALUMINIUM	2x3W	3000K	2x220 Lm	2x190 Lm	153,50 B



## WL070

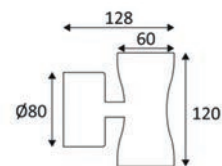
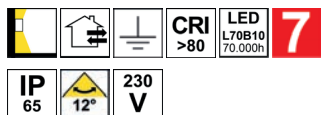

- Applique murale pour éclairage extérieur.
- Eclairage direct/indirect.
- Convertisseur non-dimmable intégré dans l'appareil.

WL070			MATIÈRE	LED	T°	System Lumen	€	
WL070BNBM27	NEW	NOIR	ALUMINIUM	2x2,5W	2700K	2x255 Lm	427,20	A
WL070BNBM30	NEW	NOIR	ALUMINIUM	2x2,5W	3000K	2x275 Lm	427,20	A
WL070SNBM27	NEW	ARGENT	ALUMINIUM	2x2,5W	2700K	2x255 Lm	427,20	A
WL070SNBM30	NEW	ARGENT	ALUMINIUM	2x2,5W	3000K	2x275 Lm	427,20	A
WL070ZNBM27	NEW	BRONZE	ALUMINIUM	2x2,5W	2700K	2x255 Lm	427,20	A
WL070ZNBM30	NEW	BRONZE	ALUMINIUM	2x2,5W	3000K	2x275 Lm	427,20	A
WL070CNBM27	NEW	CUIVRE BRILLANT	ALUMINIUM	2x2,5W	2700K	2x255 Lm	675,70	A
WL070CNBM30	NEW	CUIVRE BRILLANT	ALUMINIUM	2x2,5W	3000K	2x275 Lm	675,70	A



NOIR



ARGENT



BRONZE



CUIVRE BRILLANT





## WL070 RGBW

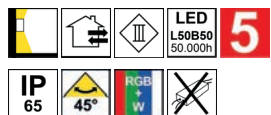

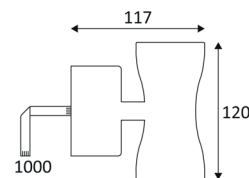

 collingwood



NEW

- Applique murale RGBW pour éclairage extérieur.
- Eclairage direct/indirect.
- 1m de câble fourni.
- Convertisseur(s), contrôleur(s), répéteur(s) de puissance et accessoires à commander séparément (voir chapitre GESTION D'ECLAIRAGE).
- Un produit par répéteur de puissance PR3011.
- Rallonge de câble 5 fils d'1m à commander séparément.

WL070 RGBW	MATIÈRE	LED	T°	System Lumen	€
WL070RGBW <b>NEW</b> ARGENT	ALUMINIUM	4x6W	RGB+W (4000K)	200 Lm (4000K)	666,40 A

ACCESSOIRES	DESCRIPTION	€
C100924 <b>NEW</b>	CONTROLEUR LED RGB(W)	 183,80 A
PR3011 <b>NEW</b>	REPETEUR DE PUISSANCE RGB(W) 350mA 4x8,4W	 108,20 A
LEDRGBWEXT <b>NEW</b>	RALLONGE RGBW 5 FILS PLUG & PLAY 1m	 10,10 A



## CHERA

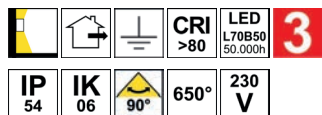

- Applique murale pour éclairage extérieur.
- Eclairage "up&down".
- Convertisseur non dimmable intégré dans l'appareil.

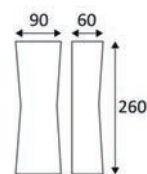

CHERA	MATIÈRE	LED	T°	LED Lumen	System Lumen	€	
OU363WW24	ANTHRACITE	FONTE D'ALUMINIUM	2x6W	3000K	2x680 Lm	2x446 Lm	139,10 B

## LUXI 190

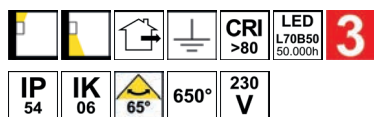

- Applique murale pour éclairage extérieur.
- Eclairage "up" ou "down".
- Convertisseur non dimmable intégré dans l'appareil.

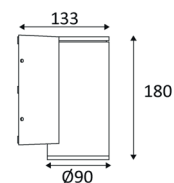

LUXI 190	MATIÈRE	LED	T°	LED Lumen	System Lumen	€	
OU10524	ANTHRACITE	FONTE D'ALUMINIUM	12W	3000K	850 Lm	586 Lm	180,30 B

## LUXI 290

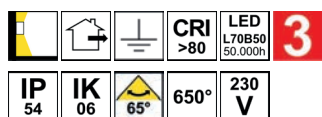

- Applique murale pour éclairage extérieur.
- Eclairage "up&down".
- Convertisseur non dimmable intégré dans l'appareil.

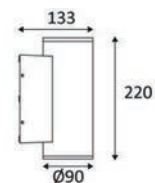

LUXI 290	MATIÈRE	LED	T°	LED Lumen	System Lumen	€	
OU10624	ANTHRACITE	FONTE D'ALUMINIUM	2x12W	3000K	2x850 Lm	2x586 Lm	268,80 B



# INDIGO

LIGHTING

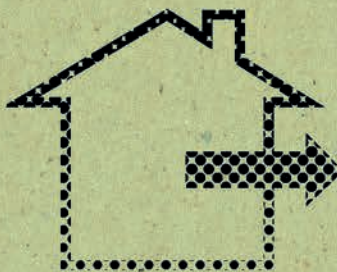

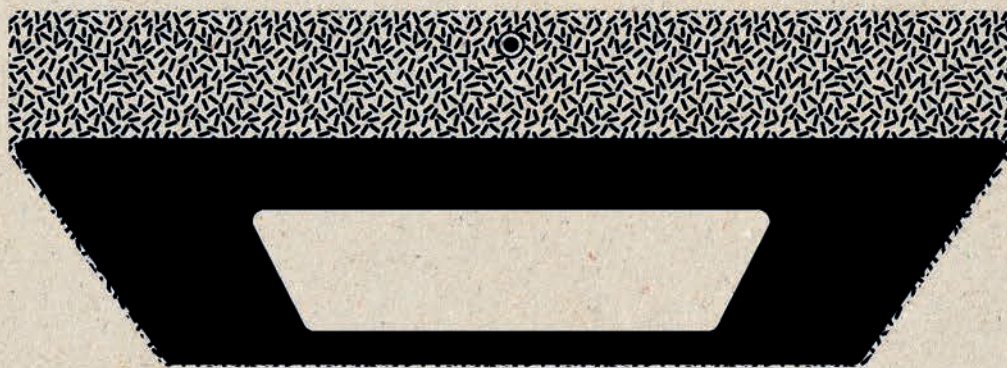

## **PLAFONNIERS**

## ROMY R GU10

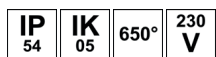

- Plafonnier rond pour éclairage extérieur.
- Diffuseur en verre.
- Avec entrée et sortie de câble.

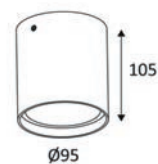

ROMY R GU10		MATIÈRE	SOCKET	LAMP	Watt Max	€
OU50405	■ NOIR MAT	ALUMINIUM	GU10	PAR16 LED	7W	69,00 B
OU50430	■ BLANC MAT	ALUMINIUM	GU10	PAR16 LED	7W	69,00 B



NOIR MAT



BLANC MAT

## ROMY S GU10

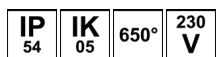

- Plafonnier carré pour éclairage extérieur.
- Diffuseur en verre.
- Avec entrée et sortie de câble.

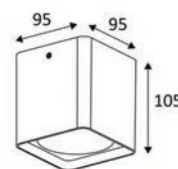

ROMY S GU10		MATIÈRE	SOCKET	LAMP	Watt Max	€
OU50505	■ NOIR MAT	ALUMINIUM	GU10	PAR16 LED	7W	69,00 B
OU50530	■ BLANC MAT	ALUMINIUM	GU10	PAR16 LED	7W	69,00 B



NOIR MAT



BLANC MAT





## LEWIS

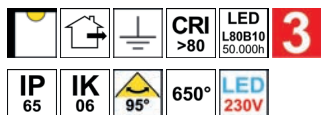

- Plafonnier pour éclairage extérieur.
- Diffuseur en verre.
- Ne nécessite pas de convertisseur.
- Non dimmable.

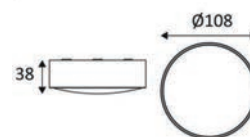

LEWIS		MATIÈRE	LED	T°	LED Lumen	System Lumen	€
OU424WW24	ANTHRACITE	FONTE D'ALUMINIUM	6W	3000K	470 Lm	320 Lm	113,30 B

## ILY

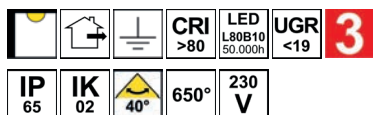

- Plafonnier pour éclairage extérieur.
- Diffuseur en verre.
- Convertisseur non dimmable intégré dans l'appareil.

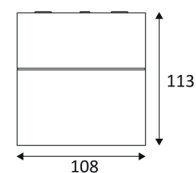

ILY		MATIÈRE	LED	T°	LED Lumen	System Lumen	€
OU512WW05	NOIR MAT	FONTE D'ALUMINIUM	5W	3000K	450 Lm	210 Lm	130,00 B
OU512WW24	ANTHRACITE	FONTE D'ALUMINIUM	5W	3000K	450 Lm	210 Lm	130,00 B



NOIR MAT



ANTHRACITE

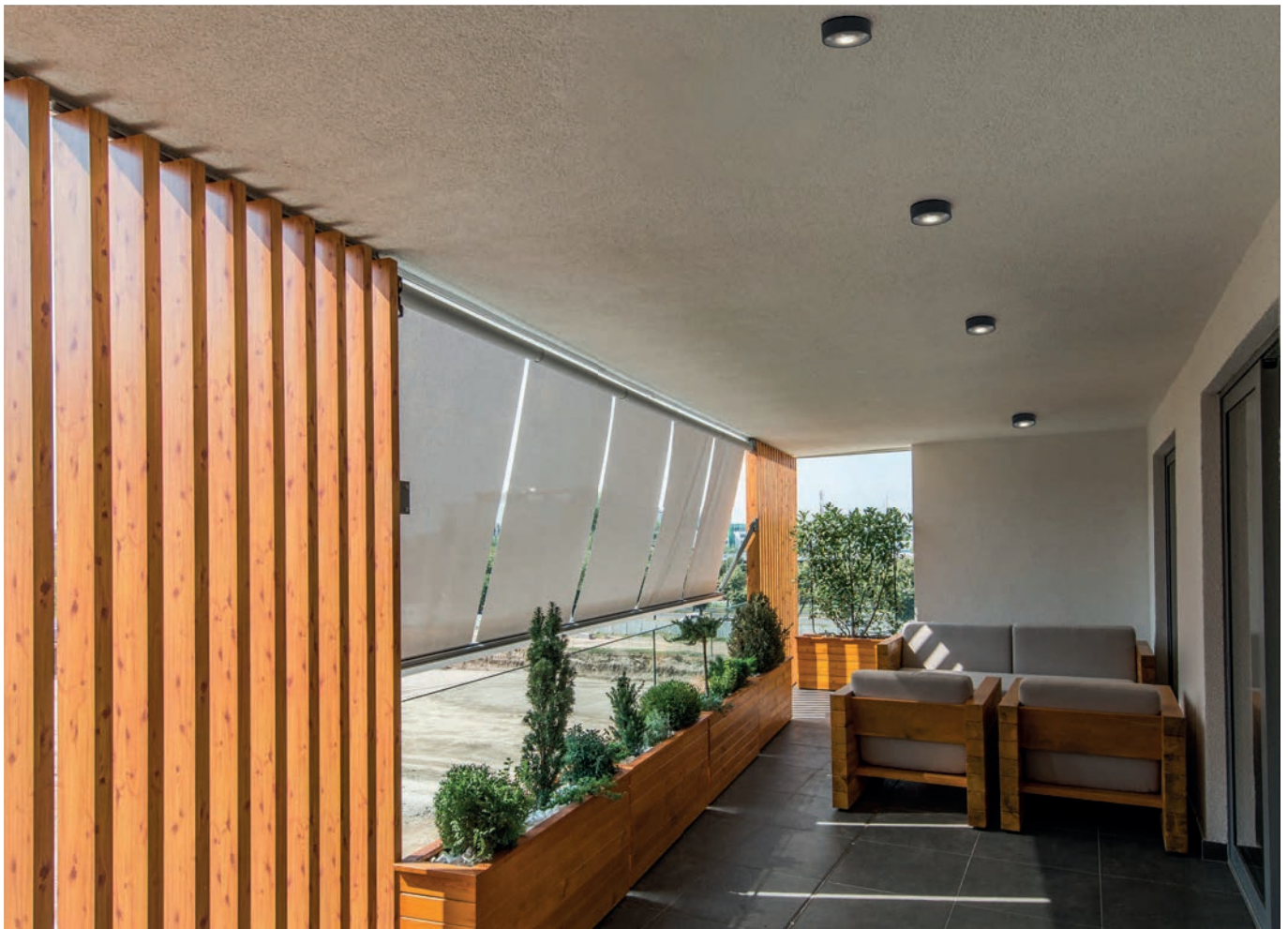

## UNIS R

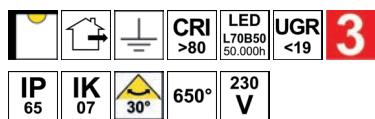

- Plafonnier rond pour éclairage extérieur.
- Réflecteur basse luminance.
- Avec entrée et sortie de câble.
- Convertisseur non dimmable intégré dans l'appareil.

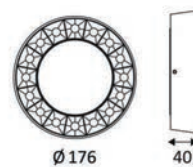

UNIS R	MATIÈRE	LED	T°	LED Lumen	System Lumen	€
OU459WW24	ANTHRACITE ALUMINIUM	14W	3000K	1250 Lm	1088 Lm	173,00 B





## UNIS S

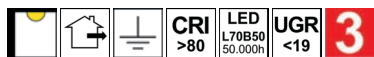

- Plafonnier carré pour éclairage extérieur.
- Réflecteur basse luminance.
- Avec entrée et sortie de câble.
- Convertisseur non dimmable intégré dans l'appareil.

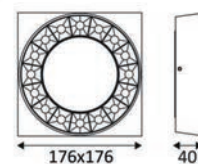

UNIS S		MATIÈRE	LED	T°	LED Lumen	System Lumen	€
OU460WW24	ANTHRACITE	ALUMINIUM	14W	3000K	1250 Lm	1088 Lm	173,00 B



## SKIP 4

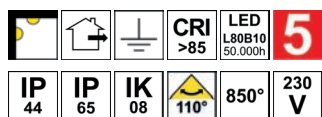

- Applique murale ou plafonnier pour éclairage extérieur.
- Diffuseur en polycarbonate opalin.
- IP65 en pose murale et IP44 en plafonnier.
- Convertisseur non dimmable intégré dans l'appareil.

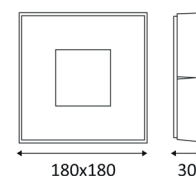

SKIP 4		MATIÈRE	LED	T°	LED Lumen	System Lumen	€
OU27901	NOIR	FONTE D'ALUMINIUM	12W	3000K	1700 Lm	1453 Lm	326,50 B
OU27903	MÉTAL	FONTE D'ALUMINIUM	12W	3000K	1700 Lm	1453 Lm	326,50 B
OU27904	BLANC	FONTE D'ALUMINIUM	12W	3000K	1700 Lm	1453 Lm	326,50 B



NOIR



MÉTAL



BLANC

## SKIP

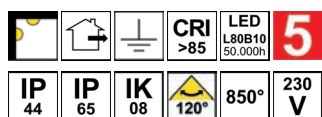

- Applique murale ou plafonnier pour éclairage extérieur.
- Réflecteur métallisé et optique en polycarbonate.
- Film translucide anti-éblouissement fourni.
- IP65 en pose murale et IP44 en plafonnier.
- Convertisseur non dimmable intégré dans l'appareil.

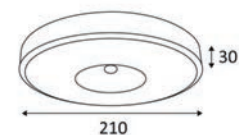

SKIP		MATIÈRE	LED	T°	LED Lumen	System Lumen	€
OU28101	NOIR	FONTE D'ALUMINIUM	12W	3000K	1800 Lm	1538 Lm	313,10 B
OU28103	MÉTAL	FONTE D'ALUMINIUM	12W	3000K	1800 Lm	1538 Lm	313,10 B
OU28104	BLANC	FONTE D'ALUMINIUM	12W	3000K	1800 Lm	1538 Lm	313,10 B



NOIR



MÉTAL



BLANC



## SKIP 2

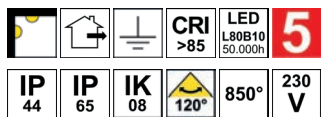

- Applique murale ou plafonnier pour éclairage extérieur.
- Réflecteur métallisé et optique en polycarbonate.
- Film translucide anti-éblouissement fourni.
- IP65 en pose murale et IP44 en plafonnier.
- Convertisseur non dimmable intégré dans l'appareil.



SKIP 2		MATIÈRE	LED	T°	LED Lumen	System Lumen	€	
OU28201	■ NOIR	FRONTON D'ALUMINIUM	30W	3000K	3800 Lm	3230 Lm	516,00	B
OU28203	■ METAL	FRONTON D'ALUMINIUM	30W	3000K	3800 Lm	3230 Lm	500,60	B
OU28204	■ BLANC	FRONTON D'ALUMINIUM	30W	3000K	3800 Lm	3230 Lm	500,60	B



NOIR

MÉTAL

BLANC



## LUZ 1

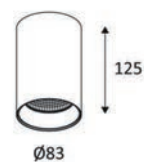
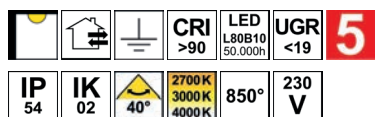

- Plafonnier pour éclairage extérieur.
- 2700K, 3000K ou 4000K au choix via un interrupteur dans le luminaire.
- Diffuseur en verre.
- Convertisseur non dimmable intégré dans l'appareil.

LUZ 1		MATIÈRE	LED	T°	LED Lumen	System Lumen	€
OU48905	■ NOIR MAT	ALUMINIUM	15W	2700-3000-4000K	1590 Lm (4000K)	945 Lm (4000K)	99,90 B
OU48930	■ BLANC MAT	ALUMINIUM	15W	2700-3000-4000K	1590 Lm (4000K)	1035 Lm (4000K)	99,90 B



NOIR MAT



BLANC MAT







## LUZ 2

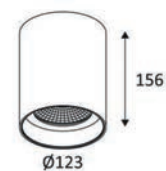
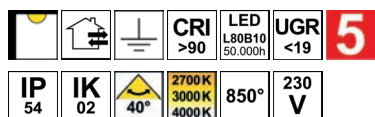

- Plafonnier pour éclairage extérieur.
- 2700K, 3000K ou 4000K au choix via un interrupteur dans le luminaire.
- Diffuseur en verre.
- Convertisseur non dimmable intégré dans l'appareil.

LUZ 2		MATIÈRE	LED	T°	LED Lumen	System Lumen	€
OU49005	 NOIR MAT	ALUMINIUM	20W	2700-3000-4000K	1930 Lm (4000K)	1475 Lm (4000K)	129,80 B
OU49030	 BLANC MAT	ALUMINIUM	20W	2700-3000-4000K	1930 Lm (4000K)	1485 Lm (4000K)	129,80 B



NOIR MAT



BLANC MAT



## FARO 1

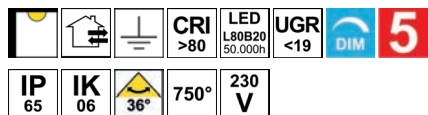

- Plafonnier pour éclairage intérieur et extérieur.
- Diffuseur en verre trempé clair.
- Avec entrée et sortie de câble.
- Convertisseur dimmable intégré dans l'appareil.
- Compatible avec variateur début et fin de phase.

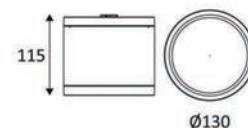

FARO 1		MATIÈRE	LED	T°	LED Lumen	System Lumen	€
OU447WW05	■ NOIR MAT	ALUMINIUM	24W	3000K	3150 Lm	2595 Lm	178,00 B
OU447WW30	■ BLANC MAT	ALUMINIUM	24W	3000K	3150 Lm	2605 Lm	178,00 B
OU447NW05	■ <b>NEW</b> NOIR MAT	ALUMINIUM	24W	4000K	3200 Lm	2770 Lm	178,00 B
OU447NW30	■ <b>NEW</b> BLANC MAT	ALUMINIUM	24W	4000K	3200 Lm	2750 Lm	178,00 B



NOIR MAT



BLANC MAT

## FARO 2

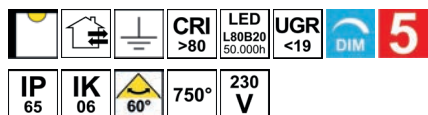

- Plafonnier pour éclairage intérieur et extérieur.
- Diffuseur en verre trempé clair.
- Avec entrée et sortie de câble.
- Convertisseur dimmable intégré dans l'appareil.
- Compatible avec variateur début et fin de phase.

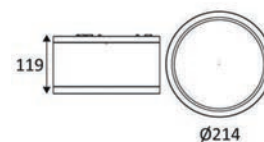

FARO 2		MATIÈRE	LED	T°	LED Lumen	System Lumen	€
OU448WW05	■ NOIR MAT	ALUMINIUM	34W	3000K	4350 Lm	3760 Lm	283,00 B
OU448WW30	■ BLANC MAT	ALUMINIUM	34W	3000K	4350 Lm	3865 Lm	283,00 B
OU448NW05	■ <b>NEW</b> NOIR MAT	ALUMINIUM	34W	4000K	4360 Lm	3940 Lm	283,00 B
OU448NW30	■ <b>NEW</b> BLANC MAT	ALUMINIUM	34W	4000K	4360 Lm	3785 Lm	283,00 B



NOIR MAT



BLANC MAT



## ASPI 1 SENSOR PLUS

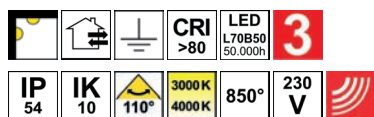

- Applique murale ou plafonnier.
- 3000K ou 4000K au choix via un interrupteur dans le luminaire.
- Avec détecteur HF 360° (plafond) 150° (mur), zone de détection réglable max. 12m de diamètre.
- Diffuseur en polycarbonate opalin.
- Convertisseur non dimmable intégré dans l'appareil.



ASPI 1 SENSOR PLUS		MATIÈRE	LED	T°	LED Lumen	System Lumen	€	
OU440NW24		ANTHRACITE	FONTE D'ALUMINIUM	30W	3000-4000K	3000 Lm (4000K)	2081 Lm (4000K)	214,00 B
OU440NW30		BLANC MAT	FONTE D'ALUMINIUM	30W	3000-4000K	3000 Lm (4000K)	2081 Lm (4000K)	214,00 B



ANTHRACITE

BLANC MAT





## ASPI 2 SENSOR PLUS

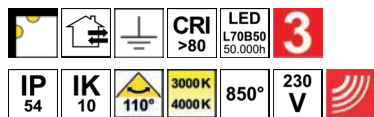

- Applique murale ou plafonnier.
- 3000K ou 4000K au choix via un interrupteur dans le luminaire.
- Avec détecteur HF 360° (plafond) 150° (mur), zone de détection réglable max. 12m de diamètre.
- Diffuseur en polycarbonate opalin.
- Convertisseur non dimmable intégré dans l'appareil.

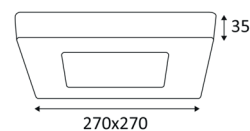

ASPI 2 SENSOR PLUS		MATIÈRE	LED	T°	LED Lumen	System Lumen	€
OU441NW24		ANTHRACITE	30W	3000-4000K	3000 Lm (4000K)	2081 Lm (4000K)	214,00 B
OU441NW30		BLANC MAT	30W	3000-4000K	3000 Lm (4000K)	2081 Lm (4000K)	214,00 B



ANTHRACITE

BLANC MAT



# INDIGO

LIGHTING



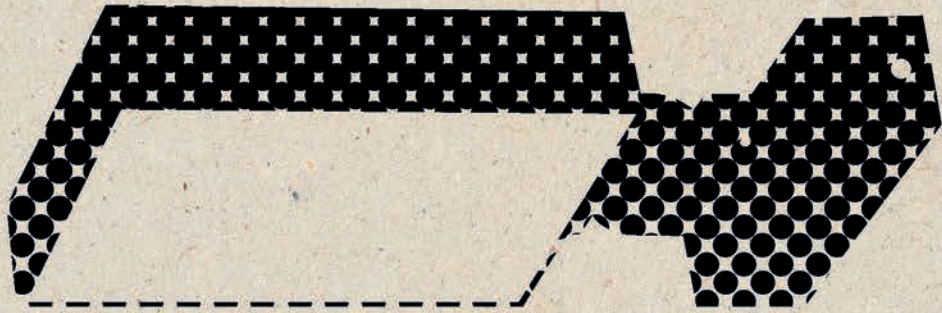

**PROJECTEURS**

## CURTIS PLUS

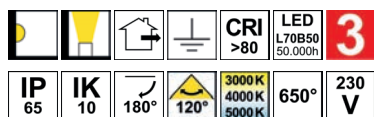

- Projecteur pour éclairage extérieur.
- 3000K, 4000K ou 5000K au choix via un interrupteur à l'arrière du luminaire.
- Diffuseur en polycarbonate.
- Livré avec 0.50m de câble.
- Convertisseur non dimmable intégré dans l'appareil.



CURTIS PLUS	MATIÈRE	LED	T°	LED Lumen	System Lumen	L (mm)	H (mm)	€
OU47024	■ ANTHRACITE FONTE D'ALUMINIUM	15W	3000-4000-5000K	1700 Lm (4000K)	1340 Lm (4000K)	147	123	34,00 B
OU47124	■ ANTHRACITE FONTE D'ALUMINIUM	30W	3000-4000-5000K	3500 Lm (4000K)	2910 Lm (4000K)	178	148	54,60 B
OU47224	■ ANTHRACITE FONTE D'ALUMINIUM	50W	3000-4000-5000K	5850 Lm (4000K)	4225 Lm (4000K)	208	170	74,20 B
OU47324	■ ANTHRACITE FONTE D'ALUMINIUM	70W	3000-4000-5000K	8000 Lm (4000K)	6435 Lm (4000K)	260	189	102,00 B

ACCESSOIRES	MATIÈRE	DESCRIPTION	€
OU17505	■ NOIR FONTE D'ALUMINIUM	CURTIS PLUS 15W PIQUET OPTIONNEL	13,40 B
OU48405		CONNECTEUR 2PIN IP68	11,30 B
OU48505		CONNECTEUR 3PIN IP68	30,90 B

## CURTIS SENSOR PLUS

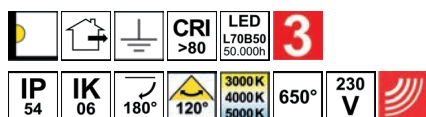

- Projecteur pour éclairage extérieur.
- 3000K, 4000K ou 5000K au choix via un interrupteur à l'arrière du luminaire.
- Diffuseur en polycarbonate.
- Livré avec 0.50m de câble.
- Avec détecteur orientable IR 120°, zone de détection réglable max. 8m.
- Convertisseur non dimmable intégré dans l'appareil.



CURTIS SENSOR PLUS	MATIÈRE	LED	T°	LED Lumen	System Lumen	L (mm)	H (mm)	€
OU47424	■ ANTHRACITE FONTE D'ALUMINIUM	15W	3000-4000-5000K	1700 Lm (4000K)	1340 Lm (4000K)	147	175	56,70 B
OU47524	■ ANTHRACITE FONTE D'ALUMINIUM	30W	3000-4000-5000K	3500 Lm (4000K)	2910 Lm (4000K)	178	201	74,20 B
OU47624	■ ANTHRACITE FONTE D'ALUMINIUM	50W	3000-4000-5000K	5850 Lm (4000K)	4225 Lm (4000K)	208	223	88,60 B

ACCESSOIRES	DESCRIPTION	€
OU48405	CONNECTEUR 2PIN IP68	11,30 B
OU48505	CONNECTEUR 3PIN IP68	30,90 B









## INDY 1

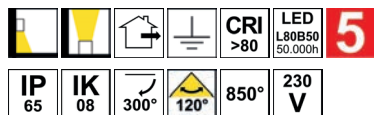

- Projecteur pour éclairage extérieur.
- Multi-puissance : 65, 80 ou 125W au choix via un interrupteur à l'arrière du luminaire.
- Diffuseur en verre trempé dépoli.
- Livré avec 1.00m de câble.
- Convertisseur non dimmable intégré dans l'appareil.

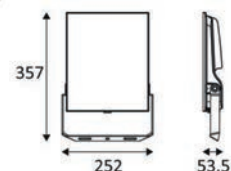

NEW

INDY 1		MATIÈRE	LED	T°	LED Lumen	System Lumen	€
FL100WW05	<b>NEW</b> NOIR	FONTE D'ALUMINIUM	65W 80W 125W	3000K	11700 Lm 14050 Lm 20900 Lm	11415 Lm 13310 Lm 18510 Lm	171,50 B
FL100NW05	<b>NEW</b> NOIR	FONTE D'ALUMINIUM	65W 80W 125W	4000K	12750 Lm 14950 Lm 22250 Lm	10630 Lm 12650 Lm 16825 Lm	171,50 B

ACCESSOIRES	DESCRIPTION	€
OU48405	CONNECTEUR 2PIN IP68	11,30 B
OU48505	CONNECTEUR 3PIN IP68	30,90 B

## INDY 1 A



- Projecteur pour éclairage extérieur.
- Multi-puissance : 65, 80 ou 125W au choix via un interrupteur à l'arrière du luminaire.
- Diffuseur en verre trempé clair.
- Faisceau asymétrique.
- Livré avec 1.00m de câble.
- Convertisseur non dimmable intégré dans l'appareil.

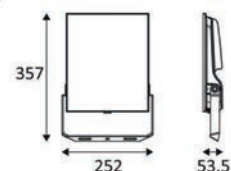

NEW

INDY 1 A		MATIÈRE	LED	T°	LED Lumen	System Lumen	€
FL102WW05	<b>NEW</b> NOIR	FONTE D'ALUMINIUM	65W 80W 125W	3000K	11700 Lm 14050 Lm 20900 Lm	10425 Lm 12040 Lm 16420 Lm	180,00 B
FL102NW05	<b>NEW</b> NOIR	FONTE D'ALUMINIUM	65W 80W 125W	4000K	12750 Lm 14950 Lm 22250 Lm	9950 Lm 11805 Lm 15565 Lm	180,00 B

ACCESSOIRES	DESCRIPTION	€
OU48405	CONNECTEUR 2PIN IP68	11,30 B
OU48505	CONNECTEUR 3PIN IP68	30,90 B

NEW

## INDY 2

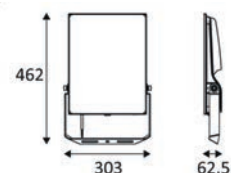
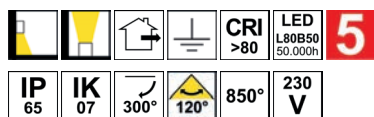

- Projecteur pour éclairage extérieur.
- Multi-puissance : 125, 165 ou 200W au choix via un interrupteur à l'arrière du luminaire.
- Diffuseur en verre trempé dépoli.
- Livré avec 1.00m de câble.
- Convertisseur non dimmable intégré dans l'appareil.

INDY 2		MATIÈRE	LED	T°	LED Lumen	System Lumen	€
FL101WW05	<b>NEW</b> NOIR	FONTE D'ALUMINIUM	125W 165W 200W	3000K	22100 Lm 27850 Lm 32150 Lm	20880 Lm 25865 Lm 30350 Lm	226,00 B
FL101NW05	<b>NEW</b> NOIR	FONTE D'ALUMINIUM	125W 165W 200W	4000K	23500 Lm 29650 Lm 34200 Lm	19165 Lm 23690 Lm 27115 Lm	226,00 B

ACCESSOIRES	DESCRIPTION	€
OU48405	CONNECTEUR 2PIN IP68	11,30 B
OU48505	CONNECTEUR 3PIN IP68	30,90 B

NEW

## INDY 2 A

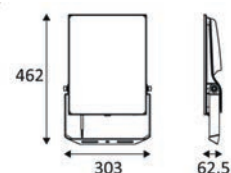
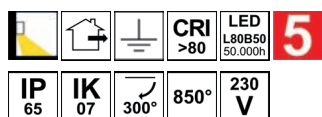

- Projecteur pour éclairage extérieur.
- Multi-puissance : 125, 165 ou 200W au choix via un interrupteur à l'arrière du luminaire.
- Diffuseur en verre trempé clair.
- Faisceau asymétrique.
- Livré avec 1.00m de câble.
- Convertisseur non dimmable intégré dans l'appareil.

INDY 2 A		MATIÈRE	LED	T°	LED Lumen	System Lumen	€
FL103WW05	<b>NEW</b> NOIR	FONTE D'ALUMINIUM	125W 165W 200W	3000K	22100 Lm 27850 Lm 32150 Lm	18440 Lm 22695 Lm 26110 Lm	243,00 B
FL103NW05	<b>NEW</b> NOIR	FONTE D'ALUMINIUM	125W 165W 200W	4000K	23500 Lm 29650 Lm 34200 Lm	18010 Lm 22355 Lm 25700 Lm	243,00 B

ACCESSOIRES	DESCRIPTION	€
OU48405	CONNECTEUR 2PIN IP68	11,30 B
OU48505	CONNECTEUR 3PIN IP68	30,90 B



## RAYPRO 14

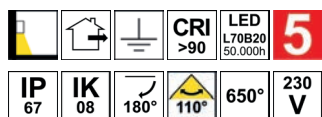

- Projecteur pour éclairage extérieur.
- Diffuseur en verre sérigraphié noir.
- Livré avec 1.50m de câble (HO5RN-F 3x0.75mm²).
- Convertisseur non dimmable intégré dans l'appareil.

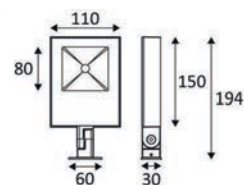

RAYPRO 14		MATIÈRE	LED	T°	LED Lumen	System Lumen	€	
PRO14/F/3K/A	NEW	ANTHRACITE	FONTE D'ALUMINIUM	14W	3000K	1700 Lm	1610 Lm	117,00 B
PRO14/F/3K/G	NEW	GRIS MAT	FONTE D'ALUMINIUM	14W	3000K	1700 Lm	1610 Lm	117,00 B
PRO14/F/3K/W	NEW	BLANC MAT	FONTE D'ALUMINIUM	14W	3000K	1700 Lm	1610 Lm	117,00 B



ANTHRACITE

GRIS MAT

BLANC MAT





## RAYPRO 32

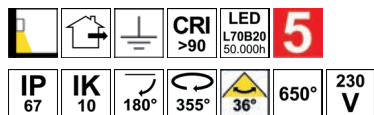

- Projecteur pour éclairage extérieur.
- Diffuseur en verre sérigraphié noir.
- Livré avec 1.50m de câble (HO5RN-F 3x0.75mm<sup>2</sup>).
- Convertisseur non dimmable intégré dans l'appareil.

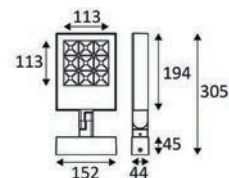

NEW

RAYPRO 32		MATIÈRE	LED	T°	LED Lumen	System Lumen	€	
PRO32/M/3K/A	NEW	ANTHRACITE	FONTE D'ALUMINIUM	32W	3000K	3200 Lm	2435 Lm	249,50 B
PRO32/M/3K/G	NEW	GRIS MAT	FONTE D'ALUMINIUM	32W	3000K	3200 Lm	2435 Lm	249,50 B
PRO32/M/3K/W	NEW	BLANC MAT	FONTE D'ALUMINIUM	32W	3000K	3200 Lm	2435 Lm	249,50 B



ANTHRACITE

GRIS MAT

BLANC MAT

## RAYPRO 32 A

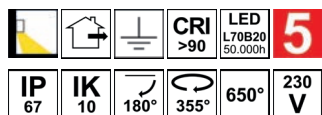

- Projecteur pour éclairage extérieur.
- Diffuseur en verre sérigraphié noir.
- Faisceau asymétrique.
- Livré avec 1.50m de câble (HO5RN-F 3x0.75mm<sup>2</sup>).
- Convertisseur non dimmable intégré dans l'appareil.

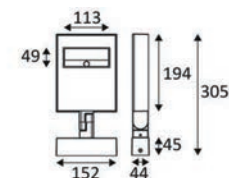

NEW

RAYPRO 32 A		MATIÈRE	LED	T°	LED Lumen	System Lumen	€	
PRO32/AS/3K/A	NEW	ANTHRACITE	FONTE D'ALUMINIUM	32W	3000K	3300 Lm	2335 Lm	230,00 B
PRO32/AS/3K/G	NEW	GRIS MAT	FONTE D'ALUMINIUM	32W	3000K	3300 Lm	2335 Lm	230,00 B
PRO32/AS/3K/W	NEW	BLANC MAT	FONTE D'ALUMINIUM	32W	3000K	3300 Lm	2335 Lm	230,00 B



ANTHRACITE

GRIS MAT

BLANC MAT

NEW

## RAYPRO 50

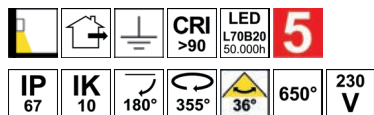

- Projecteur pour éclairage extérieur.
- Diffuseur en verre sérigraphié noir.
- Livré avec 1.50m de câble (HO5RN-F 3x0.75mm<sup>2</sup>).
- Convertisseur non dimmable intégré dans l'appareil.

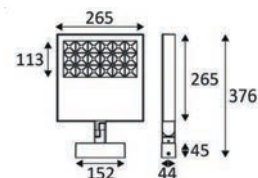

RAYPRO 50		MATIÈRE	LED	T°	LED Lumen	System Lumen	€	
PRO50/M/3K/A	NEW	ANTHRACITE	FONTE D'ALUMINIUM	50W	3000K	5400 Lm	4120 Lm	317,50 B
PRO50/M/3K/G	NEW	GRIS MAT	FONTE D'ALUMINIUM	50W	3000K	5400 Lm	4120 Lm	317,50 B
PRO50/M/3K/W	NEW	BLANC MAT	FONTE D'ALUMINIUM	50W	3000K	5400 Lm	4120 Lm	317,50 B



ANTHRACITE

GRIS MAT

BLANC MAT

NEW

## RAYPRO 50 A

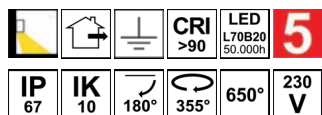

- Projecteur pour éclairage extérieur.
- Diffuseur en verre sérigraphié noir.
- Faisceau asymétrique.
- Livré avec 1.50m de câble (HO5RN-F 3x0.75mm<sup>2</sup>).
- Convertisseur non dimmable intégré dans l'appareil.

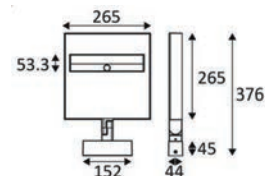

RAYPRO 50 A		MATIÈRE	LED	T°	LED Lumen	System Lumen	€	
PRO50/AS/3K/A	NEW	ANTHRACITE	FONTE D'ALUMINIUM	50W	3000K	5650 Lm	4490 Lm	296,50 B
PRO50/AS/3K/G	NEW	GRIS MAT	FONTE D'ALUMINIUM	50W	3000K	5650 Lm	4490 Lm	296,50 B
PRO50/AS/3K/W	NEW	BLANC MAT	FONTE D'ALUMINIUM	50W	3000K	5650 Lm	4490 Lm	296,50 B



ANTHRACITE

GRIS MAT

BLANC MAT





# INDIGO

LIGHTING

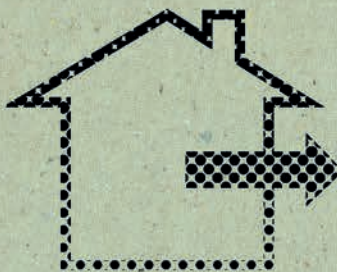

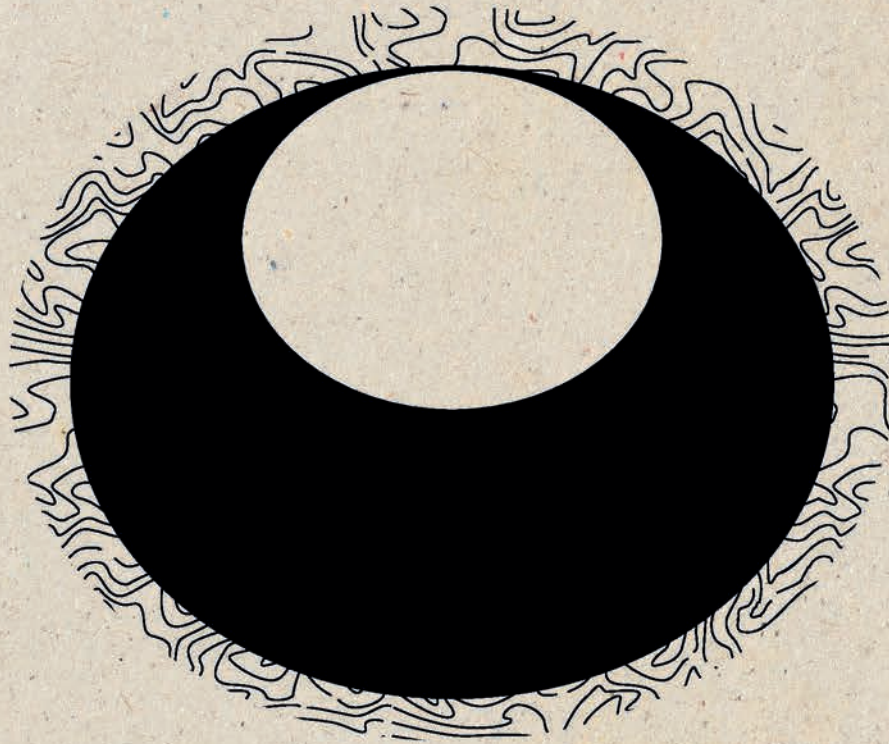

**SPOTS**

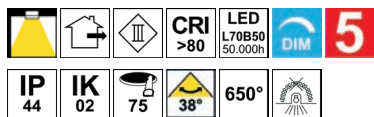
**AL3012 RD OUT**

- Spot encastré rond fixe.
- Avec traitement de surface pour une meilleure résistance.
- Réflecteur basse luminance.
- Fixation par ressorts.
- Convertisseur dimmable déporté fourni.
- Compatible avec variateur début et fin de phase.

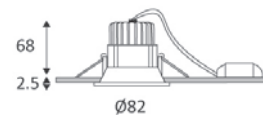

AL3012 RD OUT		MATIÈRE	LED	T°	LED Lumen	System Lumen	€
OU328WW24	■ ANTHRACITE	FORTE D'ALUMINIUM	9W	3000K	940 Lm	759 Lm	89,60 B
OU328WW30	■ BLANC MAT	FORTE D'ALUMINIUM	9W	3000K	940 Lm	759 Lm	89,60 B



ANTHRACITE

BLANC MAT





## ADA 1 RX

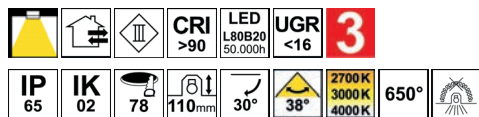

- Spot encastré rond orientable.
- 2700K, 3000K ou 4000K au choix via un interrupteur à l'arrière du luminaire.
- Fixation par ressorts.
- Convertisseur non dimmable déporté fourni.

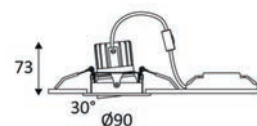

ADA 1 RX		MATIÈRE	LED	T°	LED Lumen	System Lumen	€
OU49805	■ NOIR MAT	ALUMINIUM	9W	2700-3000-4000K	1100 Lm (4000K)	775 Lm (4000K)	99,00 B
OU49830	■ BLANC MAT	ALUMINIUM	9W	2700-3000-4000K	1100 Lm (4000K)	775 Lm (4000K)	99,00 B



NOIR MAT



BLANC MAT

## ADA 2 RX

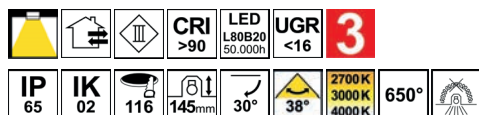

- Spot encastré rond orientable.
- 2700K, 3000K ou 4000K au choix via un interrupteur à l'arrière du luminaire.
- Fixation par ressorts.
- Convertisseur non dimmable déporté fourni.

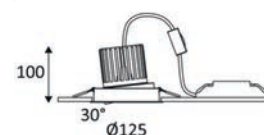

ADA 2 RX		MATIÈRE	LED	T°	LED Lumen	System Lumen	€
OU49905	■ NOIR MAT	ALUMINIUM	18W	2700-3000-4000K	2225 Lm (4000K)	1585 Lm (4000K)	149,00 B
OU49930	■ BLANC MAT	ALUMINIUM	18W	2700-3000-4000K	2225 Lm (4000K)	1585 Lm (4000K)	149,00 B



NOIR MAT



BLANC MAT



# INDIGO

LIGHTING







## **RÉGLETTES WALL-WASHER**

NEW

**ULCARGB**

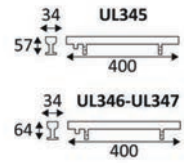

- Réglette RGB wall-washer.
- 3m de câble fourni (diamètre 6mm).
- Les pieds amovibles peuvent être installés le long de la base ou sur les côtés du produit.
- Convertisseur(s), contrôleur(s), répéteur(s) de puissance et accessoires à commander séparément (voir chapitre GESTION D'ECLAIRAGE).
- Un produit par répéteur de puissance PR3011.
- Boîte de raccordement à commander séparément.

ULCARGB		MATIÈRE	LED	T°	System Lumen	α	L (mm)	€	
UL345CARGB	<b>NEW</b>	NOIR	ALUMINIUM	3x4W	RGB	51 - 161 Lm	110°	400	587,60 A
UL346CARGB	<b>NEW</b>	NOIR	ALUMINIUM	3x4W	RGB	23 - 136 Lm	25x6°	400	587,60 A
UL347CARGB	<b>NEW</b>	NOIR	ALUMINIUM	3x4W	RGB	51 - 285 Lm	45°	400	587,60 A

ACCESSOIRES	DESCRIPTION	€
C100924	<b>NEW</b> CONTROLEUR LED RGB(W)	183,80 A
PR3011	<b>NEW</b> REPETEUR DE PUISSANCE RGB(W) 350mA 4x8,4W	108,20 A
JB3	<b>NEW</b> BOITE DE RACCORDEMENT PARALLELE 7 SORTIES IP66	24,70 A

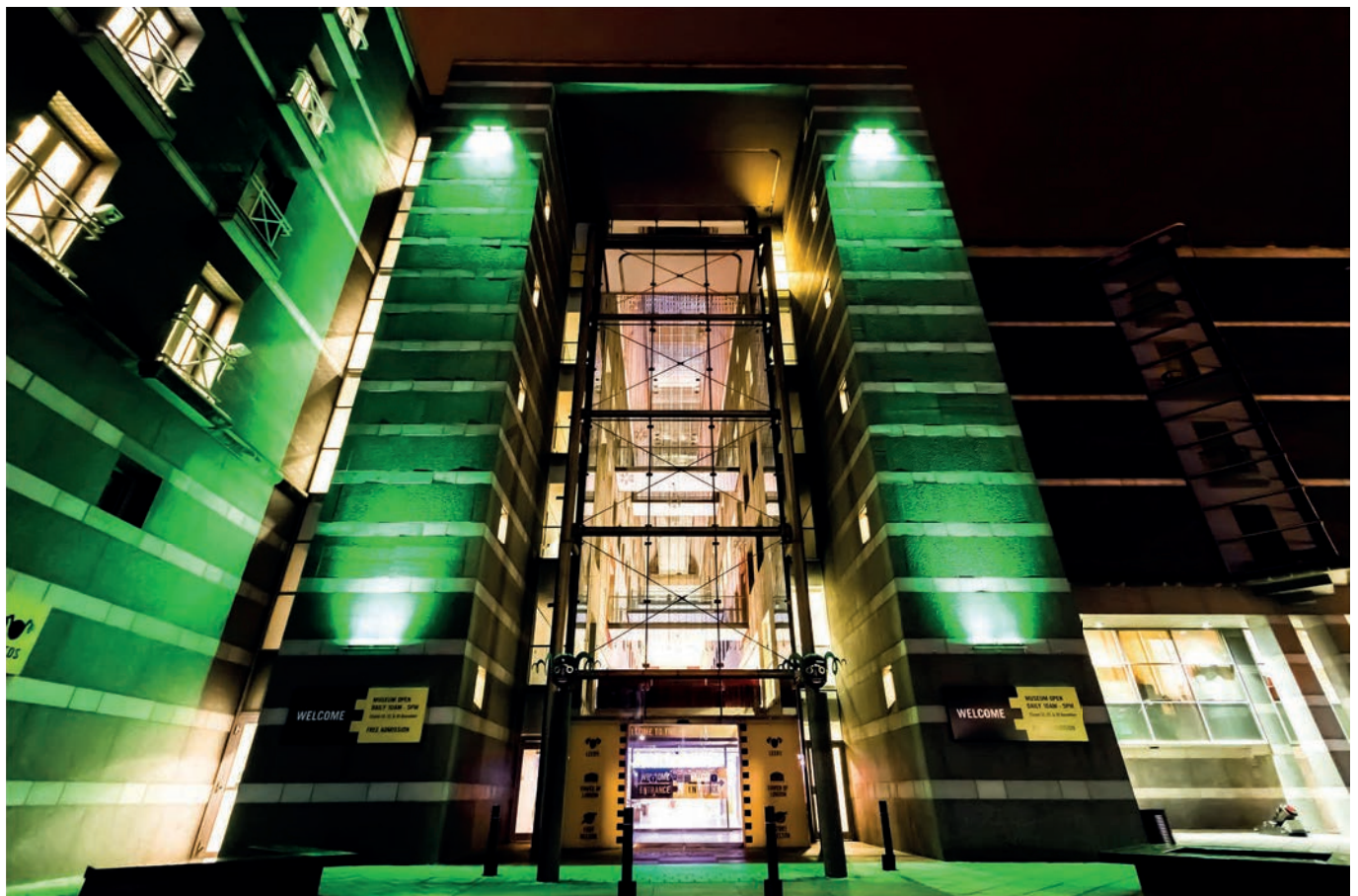



# INDIGO

LIGHTING

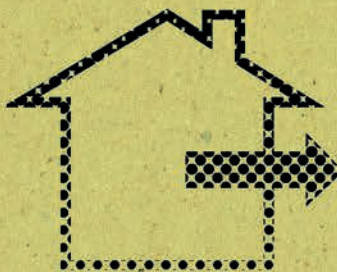

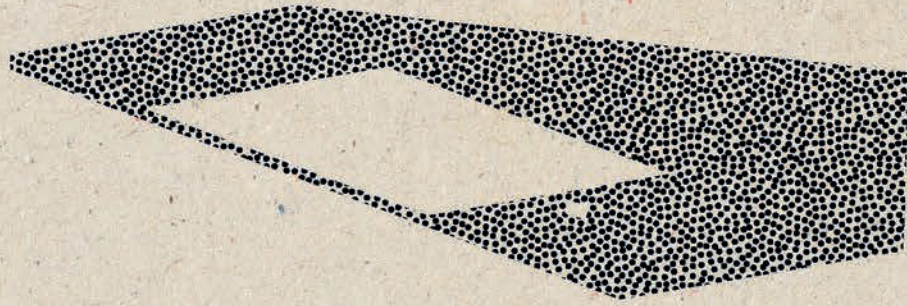

**SOLAIRES**

## PARA

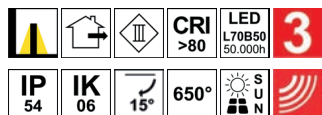

- Borne avec cellules solaires et batterie rechargeable.
- Fonctionne uniquement quand la luminosité est inférieure à 20 Lux.
- Détecteur IR 120°, distance de détection max. 6m.
- Trois modes:
  - ON  
100% de luminosité pendant 6 heures sans détection
  - DIM  
20% de luminosité pendant 4 heures, quand un mouvement est détecté, le luminaire passe à 100% de luminosité pendant 15 secondes puis à 20% de luminosité
  - AUTO  
lorsqu'un mouvement est détecté le luminaire s'allume à 100% de luminosité pendant 15 secondes puis s'éteint.
- Temps de charge 8 heures en plein ensoleillement.
- Piquet à enterrer inclus.



PARA	MATIÈRE	LED	T°	LED Lumen	System Lumen	€	
OU435WW24	ANTHRACITE	FONTE D'ALUMINIUM	1W	3000K	110 Lm	73 Lm	179,20 B

ACCESSOIRES	DESCRIPTION	€
OU446	BATTERIE DE REMPLACEMENT	19,60 B
OU469	PIQUET DE REMPLACEMENT	3,10 B

## ADES

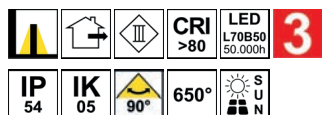

- Borne avec cellules solaires et batterie rechargeable.
- Fonctionne uniquement quand la luminosité est inférieure à 20 Lux.
- Avec interrupteur.
- Temps de charge 6 à 8 heures en plein ensoleillement avec une autonomie de 7 heures.
- Piquet à enterrer inclus.

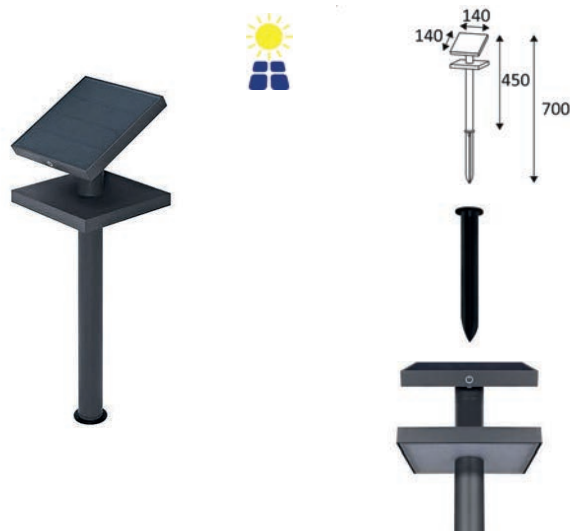

ADES	MATIÈRE	LED	T°	LED Lumen	System Lumen	€	
OU418NW24	ANTHRACITE	FONTE D'ALUMINIUM	1,3W	4000K	400 Lm	110 Lm	154,50 B

ACCESSOIRES	DESCRIPTION	€
OU445	BATTERIE DE REMPLACEMENT	19,60 B
OU468	PIQUET DE REMPLACEMENT	6,20 B



## RAMA W

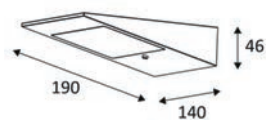
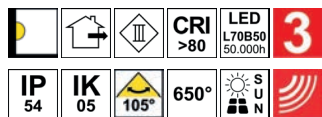



- Applique avec cellules solaires et batterie rechargeable.
- Fonctionne uniquement quand la luminosité est inférieure à 20 Lux.
- Avec interrupteur et détecteur HF 180°, distance de détection max. 6m.
- Deux niveaux d'éclairage après détection, 195 lumens pendant 30 secondes puis 30 lumens avec une autonomie de 15 heures.
- Temps de charge 6 à 8 heures en plein ensoleillement.

RAMA W	MATIÈRE	LED	T°	LED Lumen	System Lumen	€	
OU464WW24	ANTHRACITE	FONTE D'ALUMINIUM	2W	3000K	550 Lm	195 Lm	158,60 B
ACCESSOIRES	DESCRIPTION			€			
OU445	BATTERIE DE REMPLACEMENT			19,60	B		

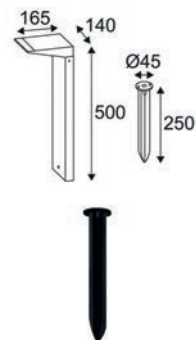
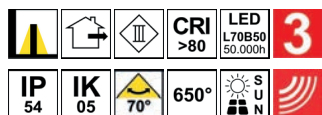
## RAMA P



- Borne avec cellules solaires et batterie rechargeable.
- Fonctionne uniquement quand la luminosité est inférieure à 20 Lux.
- Avec interrupteur et détecteur HF 180°, distance de détection max. 6m.
- Deux niveaux d'éclairage après détection, 140 lumens pendant 30 secondes puis 20 lumens avec une autonomie de 15 heures.
- Temps de charge 6 à 8 heures en plein ensoleillement.
- Piquet à enterrer inclus.

RAMA P	MATIÈRE	LED	T°	LED Lumen	System Lumen	€	
OU348WW24	ANTHRACITE	FONTE D'ALUMINIUM	2W	3000K	550 Lm	140 Lm	172,00 B
OU348NW24	ANTHRACITE	FONTE D'ALUMINIUM	2W	4000K	600 Lm	140 Lm	172,00 B
ACCESSOIRES	DESCRIPTION			€			
OU445	BATTERIE DE REMPLACEMENT			19,60	B		
OU468	PIQUET DE REMPLACEMENT			6,20	B		





## KALA

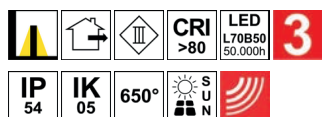

- Borne carrée avec cellules solaires et batterie rechargeable.
- Fonctionne uniquement quand la luminosité est inférieure à 20 Lux.
- Avec interrupteur et détecteur IR 120°, rayon de détection max. 6m.
- Deux niveaux d'éclairage après détection, 225 lumens pendant 45 secondes puis 35 lumens avec une autonomie de 15 heures.
- Temps de charge 6 à 8 heures en plein ensoleillement.
- Piquet à enterrer inclus.

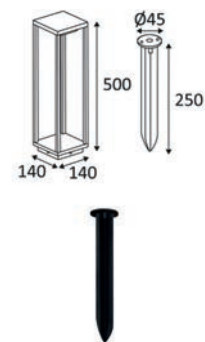

KALA	MATIÈRE	LED	T°	LED Lumen	System Lumen	€	
OU342NW24	ANTHRACITE	FONTE D'ALUMINIUM	2W	4000K	600 Lm	225 Lm	199,80 B

ACCESSOIRES	DESCRIPTION	€
OU445	BATTERIE DE REMPLACEMENT	19,60 B
OU468	PIQUET DE REMPLACEMENT	6,20 B

## YELY

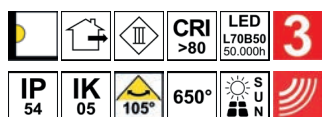

- Applique avec cellules solaires et batterie rechargeable.
- Fonctionne uniquement quand la luminosité est inférieure à 20 Lux.
- Avec interrupteur et détecteur HF 180°, distance de détection max. 6m.
- Deux niveaux d'éclairage après détection, 170 lumens pendant 30 secondes puis 25 lumens avec une autonomie de 15 heures.
- Temps de charge 6 à 8 heures en plein ensoleillement.

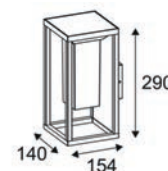

YELY	MATIÈRE	LED	T°	LED Lumen	System Lumen	€	
OU412NW24	ANTHRACITE	FONTE D'ALUMINIUM	2W	4000K	600 Lm	170 Lm	183,30 B

ACCESSOIRES	DESCRIPTION	€
OU445	BATTERIE DE REMPLACEMENT	19,60 B



# INDIGO

LIGHTING

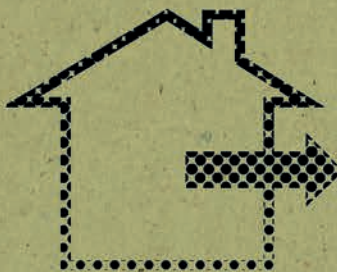

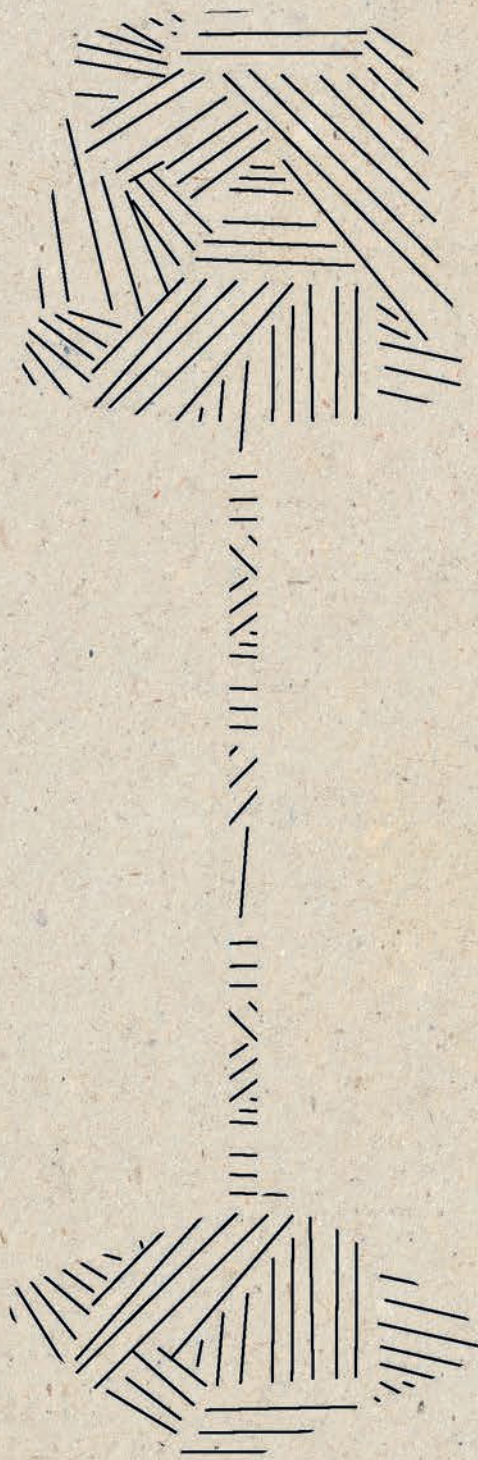

## **MOBILES**

## MOON



- Luminaire portable.
- Avec interrupteur permettant trois niveaux d'éclairage (25%, 50% et 100%) et batterie rechargeable via prise USB.
- Temps de charge 5 heures avec une autonomie de 5 heures à 100%, 10 heures à 50% et 20 heures à 25% de luminosité.
- Livré avec câble USB, sans chargeur.
- La base aimantée est livrée avec un autocollant double face pour toutes les surfaces et 2 vis.
- Base et chargeur à commander séparément.

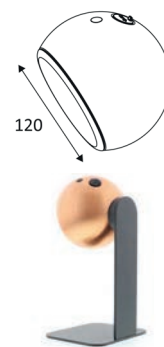

MOON		MATIÈRE	LED	T°	LED Lumen	System Lumen	€
WA204WW30	BLANC MAT	ALUMINIUM	1,5W	2700K	170 Lm	100 Lm	116,40 B
WA204WW05	NOIR MAT	ALUMINIUM	1,5W	2700K	170 Lm	100 Lm	116,40 B
WA204WW03	CHROME	ALUMINIUM	1,5W	2700K	170 Lm	100 Lm	137,00 B
WA204WW88	CUIVRE BROSSE	ALUMINIUM	1,5W	2700K	170 Lm	100 Lm	151,40 B

ACCESSOIRES		DESCRIPTION		€
WA20505	NOIR	BASE AIMANTÉE		33,00 B
WA20605	NOIR	BASE LAMPE DE BUREAU		53,60 B
WA20703	CHROME	BASE + FILIN DE SUSPENSION 2m		44,30 B
WA20804	BLANC	CHARGEUR USB		21,60 B
OU42304	BLANC	CHARGEUR MULTI USB (8 PORTS)		90,60 B

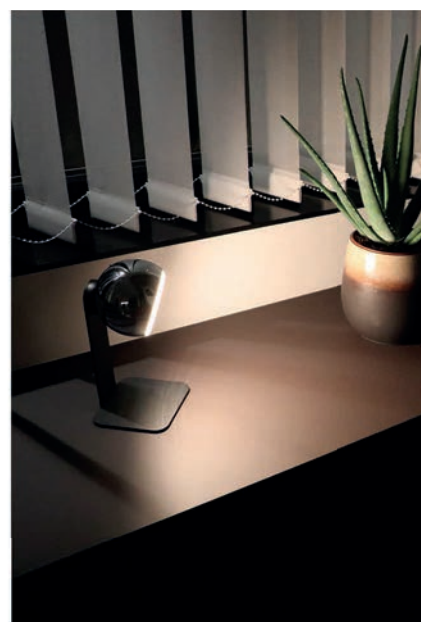
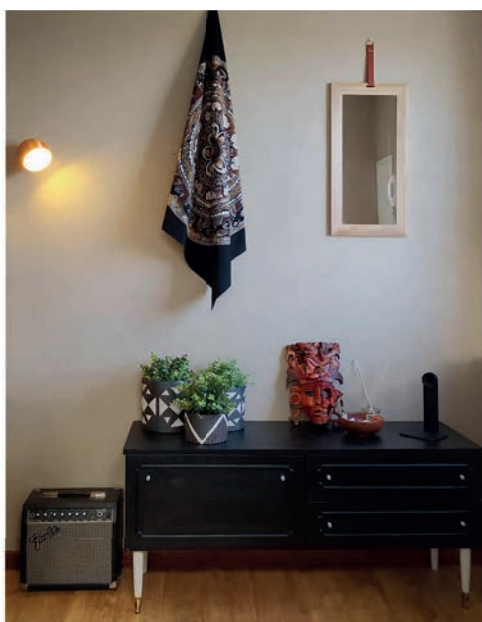



## MINI SHADE



- Luminaire portatif.
- Avec interrupteur et batterie rechargeable via prise USB.
- Temps de charge 6 heures avec une autonomie de 9 heures.
- Livré avec chargeur.
- Dimmable.

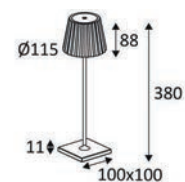

MINI SHADE		MATIÈRE	LED	T°	LED Lumen	System Lumen	€
OU355WW30	BLANC MAT	ALUMINIUM	2W	3000K	470 Lm	180 Lm	158,60 B
OU355WW24	ANTHRACITE	ALUMINIUM	2W	3000K	470 Lm	180 Lm	158,60 B

ACCESSOIRES		DESCRIPTION	€
OU42304	BLANC	CHARGEUR MULTI USB (8 PORTS)	90,60 B



BLANC MAT

ANTHRACITE







## MINI VARA



- Luminaire portatif.
- Avec interrupteur et batterie rechargeable via prise USB.
- Temps de charge 6 heures avec une autonomie de 9 heures.
- Livré avec chargeur.
- Dimmable.

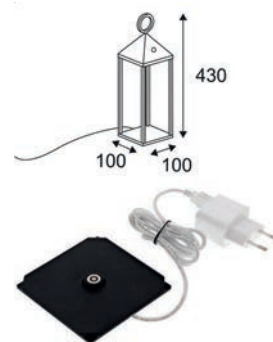

MINI VARA	MATÉRIE	LED	T°	LED Lumen	System Lumen	€	
OU422WW24	ANTHRACITE	FONTE D'ALUMINIUM	2W	3000K	580 Lm	150 Lm	136,00 B
OU422WW30	BLANC MAT	FONTE D'ALUMINIUM	2W	3000K	580 Lm	150 Lm	136,00 B

ACCESSOIRES	DESCRIPTION	€
OU42024	ANTHRACITE CROCHET MURAL	14,40 B
OU42030	BLANC MAT CROCHET MURAL	14,40 B
OU42124	ANTHRACITE SUSPENSION 2m	29,90 B
OU42130	BLANC MAT SUSPENSION 2m	29,90 B
OU42304	BLANC CHARGEUR MULTI USB (8 PORTS)	90,60 B



ANTHRACITE



BLANC MAT





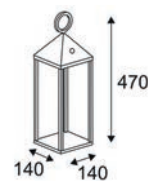
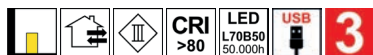

## VARA



- Luminaire portatif.
- Avec interrupteur et batterie rechargeable via prise USB.
- Temps de charge 6 heures avec une autonomie de 9 heures.
- Livré avec chargeur.

VARA		MATIÈRE	LED	T°	LED Lumen	System Lumen	€
OU347WW24	■ ANTHRACITE	FONTE D'ALUMINIUM	2W	3000K	580 Lm	220 Lm	156,60 B
ACCESSOIRES		DESCRIPTION					€
OU42024	■ ANTHRACITE	CROCHET MURAL		14,40	B		
OU42124	■ ANTHRACITE	SUSPENSION 2m		29,90	B		
OU42304	■ BLANC	CHARGEUR MULTI USB (8 PORTS)		90,60	B		



## LIKI

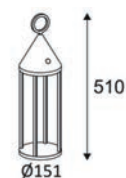

- Luminaire portatif.
- Avec interrupteur et batterie rechargeable via prise USB.
- Temps de charge 6 heures avec une autonomie de 9 heures.
- Livré avec chargeur.
- Dimmable.

LIKI		MATIÈRE	LED	T°	LED Lumen	System Lumen	€	
OU399WW24		ANTHRACITE	FONTE D'ALUMINIUM	2W	3000K	580 Lm	170 Lm	168,90 B
OU399WW30		BLANC MAT	FONTE D'ALUMINIUM	2W	3000K	580 Lm	170 Lm	168,90 B

ACCESSOIRES		DESCRIPTION	€	
OU42024		ANTHRACITE	CROCHET MURAL	14,40 B
OU42030		BLANC MAT	CROCHET MURAL	14,40 B
OU42124		ANTHRACITE	SUSPENSION 2m	29,90 B
OU42130		BLANC MAT	SUSPENSION 2m	29,90 B
OU42304		BLANC	CHARGEUR MULTI USB (8 PORTS)	90,60 B



ANTHRACITE



BLANC MAT





## SUNY 1

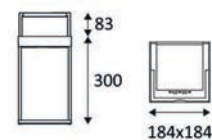
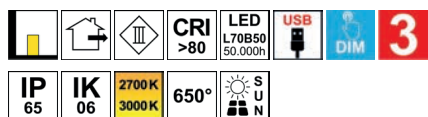

- Luminaire portatif.
- 2700K ou 3000K au choix via un interrupteur.
- 2 modes, automatique (fonctionne uniquement si luminosité <30 lux) ou manuel.
- Avec interrupteur et batterie rechargeable via prise USB ou via cellules solaires.
- Temps de charge 6 heures (USB), 20 heures (solaire) avec une autonomie de 20 heures (50%), 9 heures (100% d'intensité).
- Livré avec câble USB, sans chargeur.
- Dimmable.

SUNY 1	MATIERE	LED	T°	LED Lumen	System Lumen	€	
OU45424	ANTHRACITE	ALUMINIUM	2,2W	2700-3000K	210 Lm (3000K)	120 Lm (3000K)	191,60 B
OU45447	ACIER CORTEN	ALUMINIUM	2,2W	2700-3000K	210 Lm (3000K)	120 Lm (3000K)	191,60 B

ACCESSOIRES	DESCRIPTION	€
OU45524	ANTHRACITE CROCHET MURAL	22,70 B
OU45547	ACIER CORTEN CROCHET MURAL	22,70 B



ANTHRACITE



ACIER CORTEN

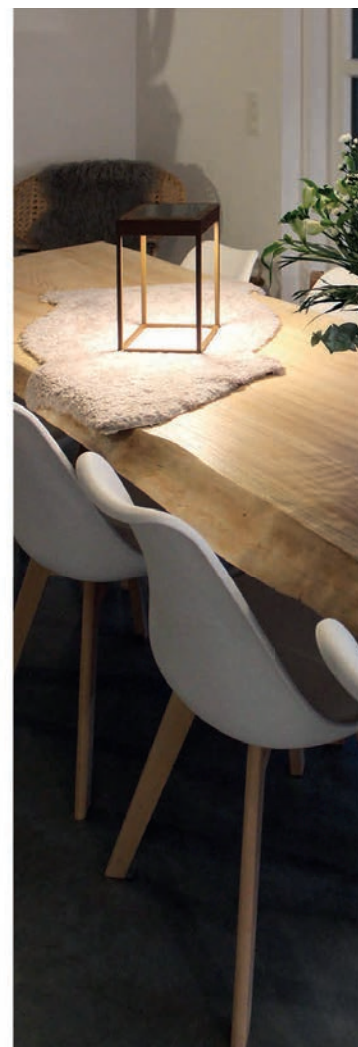



## SUNY 2

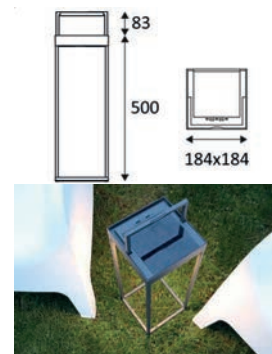
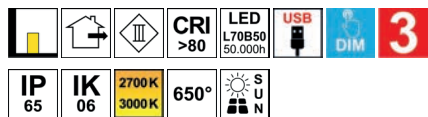

- Luminaire portatif.
- 2700K ou 3000K au choix via un interrupteur.
- 2 modes, automatique (fonctionne uniquement si luminosité <30 lux) ou manuel.
- Avec interrupteur et batterie rechargeable via prise USB ou via cellules solaires.
- Temps de charge 6 heures (USB), 20 heures (solaire) avec une autonomie de 20 heures (50%), 9 heures (100% d'intensité).
- Livré avec câble USB, sans chargeur.
- Dimmable.

SUNY 2	MATIERE	LED	T°	LED Lumen	System Lumen	€	
OU45624	ANTHRACITE	ALUMINIUM	2,2W	2700-3000K	210 Lm (3000K)	120 Lm (3000K)	198,80 B
OU45647	ACIER CORTEN	ALUMINIUM	2,2W	2700-3000K	210 Lm (3000K)	120 Lm (3000K)	198,80 B

ACCESSOIRES	DESCRIPTION	€
OU45524	ANTHRACITE CROCHET MURAL	22,70 B
OU45547	ACIER CORTEN CROCHET MURAL	22,70 B



ANTHRACITE



ACIER CORTEN



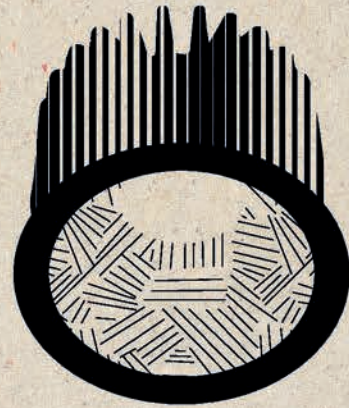

# INDIGO

LIGHTING

## ACCESSOIRES

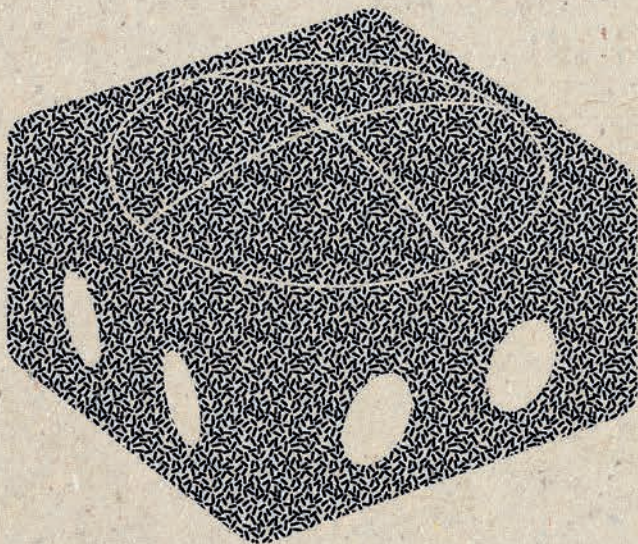





**SOURCES ET DOUILLES**

**ALIMENTATIONS**

**GESTION D'ÉCLAIRAGE**

**NEW**

**CÂBLES**

**NEW**

**BOÎTES DE RACCORDEMENT  
ET CONNECTEURS IP**



**INDIGO**



**LIGHTING**

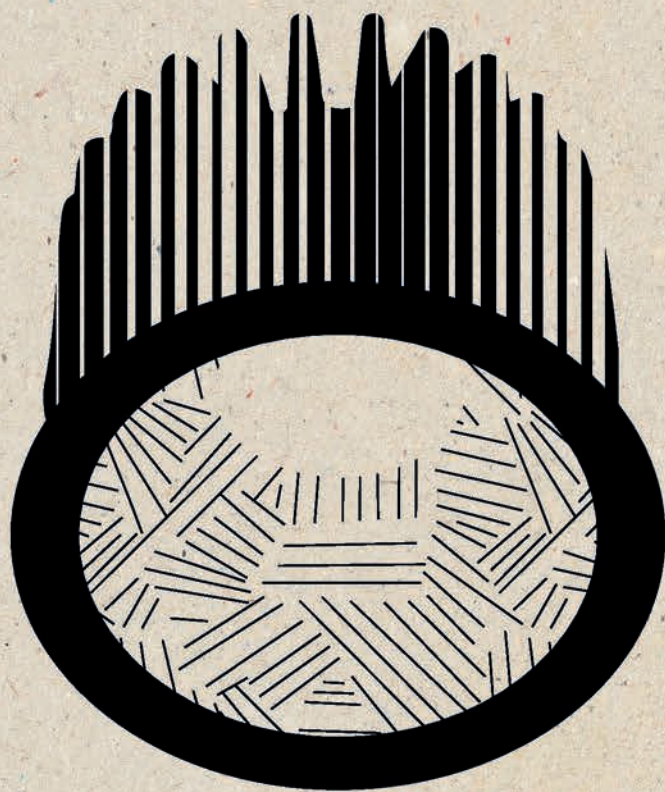

## **SOURCES ET DOUILLES**

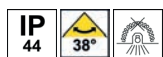
**MODU LED**

- Module LED d'un diamètre identique à une PAR16 230V ou MR16 12V.
- Compatible avec KSA 1002 / 1012, KASA et ALA1013.
- Convertisseur dimmable déporté fourni.
- Compatible avec variateur début et fin de phase.
- Durée de vie : 30.000h.

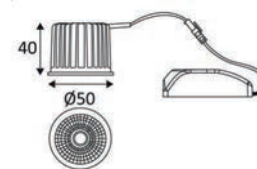

MODU LED	LED	T°	LED Lumen	System Lumen	€
LED9W500DWW	9W	3000K	940 Lm	830 Lm	50,50 B

**SUP 08 AUTO****230  
V**

- Etrier avec douille GU10.
- Double bornier automatique.
- Ne nécessite aucun outil.

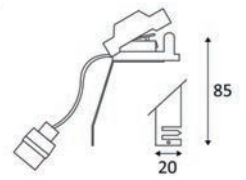

<b>SUP 08 AUTO</b>	<b>SOCKET</b>	<b>Watt Max</b>	<b>€</b>
SUP08	GU10	50W	5,20 B

**INDIGO**



**LIGHTING**



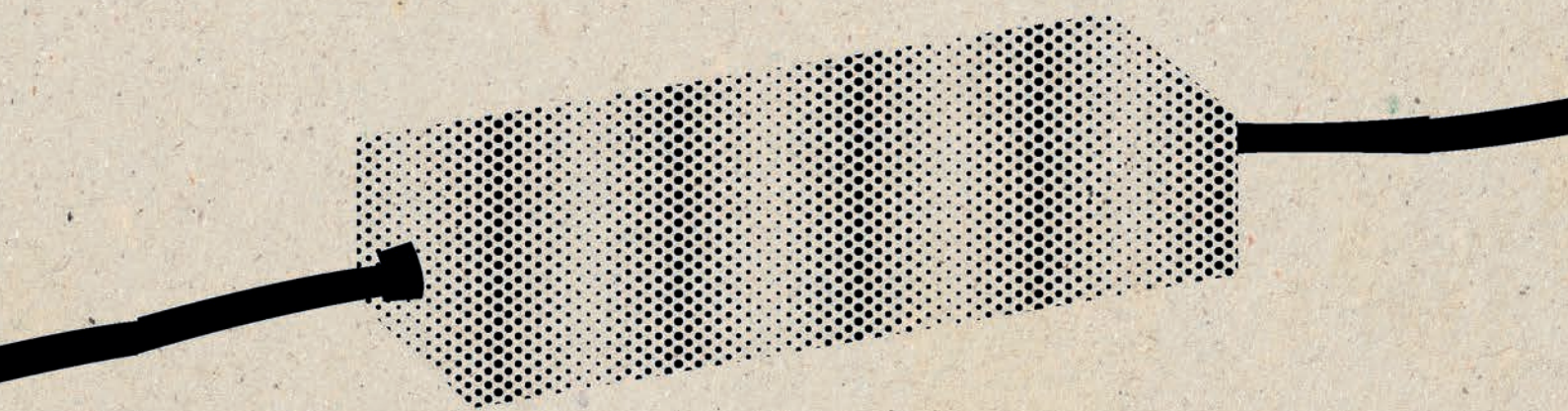







# **ALIMENTATIONS**







## CC NON DIMMABLES

	CODE	Watt Max	PRI	SEC	INPUTS	OUTPUTS	L (mm)	I (mm)	H (mm)	€	
<b>5</b>	 CD155	2-3W	AC 230V	DC 350mA	1	1	86	32	23	27,80	B
<b>2</b>	 PLR35015	<b>NEW</b> 1-5W	AC 230V	DC 350mA	1	1	53	53	19	43,90	A
<b>2</b>	 CD170	5,5-7W	AC 230V	DC 350mA	1	1	71	36	22	18,50	B
<b>2</b>	 PLU35019	<b>NEW</b> 1-9W	AC 230V	DC 350mA	1	1	111	48	28	50,90	A
<b>2</b>	 PLUPP35019	<b>NEW</b> 1-9W	AC 230V	DC 350mA	1	1	111	48	28	58,00	A
<b>2</b>	 CD128	1-15W	AC 230V	DC 350mA	1	1	115	33	19	63,90	B
<b>2</b>	 PLU70039	<b>NEW</b> 3-9W	AC 230V	DC 700mA	1	2	138	40	28	72,70	A





## CC NON DIMMABLES IP65

	CODE	Watt Max	PRI	SEC	INPUTS	OUTPUTS	L (mm)	I (mm)	H (mm)	€	
<b>5</b>	 PSIP3509W	<b>NEW</b> 1-9W	AC 230V	DC 350mA	1	1	149	37	24	44,00	A
<b>5</b>	 PSIP35018W	<b>NEW</b> 9-18W	AC 230V	DC 350mA	1	1	149	37	24	57,70	A
<b>5</b>	 CD172	2-4W	AC 230V	DC 700mA	1	1	50	27,5	21	15,50	B
<b>5</b>	 PSIP70018W	<b>NEW</b> 2-18W	AC 230V	DC 700mA	1	1	149	37	24	56,10	A
<b>5</b>	 PSIP70036W	<b>NEW</b> 18-36W	AC 230V	DC 700mA	1	1	162	41	24	73,40	A







## CC NON DIMMABLES IP67

	CODE	Watt Max	PRI	SEC	INPUTS	OUTPUTS	L (mm)	I (mm)	H (mm)	€	
<b>2</b>	 CD114	2-18W	AC 230V	DC 350mA	1	1	140	30	22	45,30	B
<b>2</b>	 CD105	9-35W	AC 230V	DC 700mA	1	1	148	40	30	95,80	B





## DIM 1-10V

	CODE	Watt Max	PRI	SEC	INPUTS	OUTPUTS	L (mm)	I (mm)	H (mm)	€	
<b>5</b>	 PLDUNIDRIVE350MA	<b>NEW</b> 1-10W	AC 230V	DC 350mA	1	1	103	67	22	118,60	A
<b>5</b>	 PSDIM350	<b>NEW</b> 1-18W	AC 230V	DC 350mA	1	1	123	79	22	170,50	A
<b>5</b>	 PLDUNIDRIVE700MA	<b>NEW</b> 3-27W	AC 230V	DC 700mA	1	1	103	67	22	107,80	A
<b>7</b>	 PSDIM700	<b>NEW</b> 3-50W	AC 230V	DC 700mA	1	1	123	79	22	164,10	A









## DIM 1-10V-DALI-PUSH

CODE	Watt Max	PRI	SEC	INPUTS	OUTPUTS	L (mm)	l (mm)	H (mm)	€
 PSDAL350M	<b>NEW</b> 1-18W	AC 230V	DC 350mA	1	1	123	79	22	<b>189,50</b> A
 PSDAL700M	<b>NEW</b> 3-50W	AC 230V	DC 700mA	1	1	123	79	22	<b>182,40</b> A



## CC DIMMABLES DALI-PUSH

CODE	Watt Max	PRI	SEC	INPUTS	OUTPUTS	L (mm)	l (mm)	H (mm)	€
 CD123	3-18W	AC 230V	DC 250mA	1	1	150	42,5	22	<b>87,60</b> B
 CD124	3-18W	AC 230V	DC 300mA	1	1	150	42,5	22	<b>87,50</b> B
 CD140	3-18W	AC 230V	DC 350mA	1	1	150	42,5	22	<b>100,90</b> B
 CD116	3-18W	AC 230V	DC 500mA	1	1	150	42,5	22	<b>95,80</b> B
 CD126	4-27W	AC 230V	DC 500mA	1	1	150	42,5	22	<b>98,90</b> B
 CD148	3-18W	AC 230V	DC 700mA	1	1	150	42,5	22	<b>80,30</b> B
 CD122	9-55W	AC 230V	DC 1050mA	1	1	103	67	22,5	<b>137,00</b> B









## CC DIMMABLES COUPURE DE PHASE

CODE	Watt Max	PRI	SEC	INPUTS	OUTPUTS	L (mm)	l (mm)	H (mm)	€
<b>5</b>  PSMD35039	<b>NEW</b> 3-9W	AC 230V	DC 350mA	1	1	123	44,6	19,2	<b>48,40</b> A
<b>3</b>  CD102	6,5-13,5W	AC 230V	DC 350mA	1	1	95	53	25	<b>42,20</b> B
<b>3</b>  CD112	9-18W	AC 230V	DC 350mA	1	1	95	53	30	<b>43,30</b> B
<b>5</b>  PSMD3501324	<b>NEW</b> 13-24W	AC 230V	DC 350mA	1	1	155	35	22	<b>74,10</b> A
<b>3</b>  CD104	9-18W	AC 230V	DC 500mA	1	1	95	53	30	<b>44,30</b> B
<b>5</b>  PSMD70024	<b>NEW</b> 2-10W	AC 230V	DC 700mA	1	1	123	44,6	19,2	<b>74,10</b> A
<b>3</b>  CD147	5-10W	AC 230V	DC 700mA	1	1	95	53	25	<b>37,10</b> B
<b>5</b>  PSMD700610	<b>NEW</b> 12-24W	AC 230V	DC 700mA	1	1	155	35	22	<b>49,40</b> A
<b>3</b>  CD125	19-35W	AC 230V	DC 700mA	1	1	153	54	36	<b>68,00</b> B







### CV NON DIMMABLES CLASSE 2

	CODE	Watt Max	PRI	SEC	INPUTS	OUTPUTS	L (mm)	I (mm)	H (mm)	€	
<b>2</b>	 CD171	0-20W	AC 230V	DC 12V	1	1	128	50	13	<b>45,30</b>	B
<b>5</b>	 CD173	<b>NEW</b> 30W	AC 230V	DC 24V	1	1	153	41	32	<b>37,80</b>	A
<b>5</b>	 CD174	<b>NEW</b> 60W	AC 230V	DC 24V	1	2	180	52	30	<b>45,40</b>	A
<b>5</b>	 CD175	<b>NEW</b> 75W	AC 230V	DC 24V	1	2	180	52	30	<b>46,70</b>	A
<b>5</b>	 CD176	<b>NEW</b> 120W	AC 230V	DC 24V	1	2	300	40	30	<b>58,50</b>	A
<b>5</b>	 CD177	<b>NEW</b> 180W	AC 230V	DC 24V	1	2	345	50	35	<b>121,70</b>	A







### CV NON DIMMABLES CLASSE 1

	CODE	Watt Max	PRI	SEC	INPUTS	OUTPUTS	L (mm)	I (mm)	H (mm)	€	
	 CD158	60W	AC 230V	DC 24V	1	1	100	78	37	<b>58,70</b>	B
	 CD150	120W	AC 230V	DC 24V	1	2	160	98	38	<b>63,90</b>	B
	 CD159	150W	AC 230V	DC 24V	1	2	160	98	38	<b>85,10</b>	B
	 CD151	200W	AC 230V	DC 24V	1	2	199	98	42	<b>92,70</b>	B



### CV NON DIMMABLE IP67

	CODE	Watt Max	PRI	SEC	INPUTS	OUTPUTS	L (mm)	I (mm)	H (mm)	€	
	 CD178	<b>NEW</b> 75W	AC 230V	DC 24V	1	1	155	49	32	<b>72,30</b>	A
	 CD179	<b>NEW</b> 100W	AC 230V	DC 24V	1	1	206	68,6	37	<b>121,70</b>	A
	 CD180	<b>NEW</b> 150W	AC 230V	DC 24V	1	1	206	68,6	37	<b>125,10</b>	A
	 CD181	<b>NEW</b> 250W	AC 230V	DC 24V	1	1	258	86,2	47,2	<b>221,70</b>	A

**CV 0-1/10V - DALI - PUSH**

CODE	Watt Max	PRI	SEC	INPUTS	OUTPUTS	L (mm)	I (mm)	H (mm)	€
 CD154	200W	AC 230V	DC 24V	1	2	310	60	45	<b>337,80</b> B

**CV DIMMABLE COUPURE DE PHASE**

CODE	Watt Max	PRI	SEC	INPUTS	OUTPUTS	L (mm)	I (mm)	H (mm)	€
 CD153	75W	AC 230V	DC 24V	1	2	295	40	32	<b>252,40</b> B

**INDIGO**



**LIGHTING**

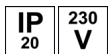

## **GESTION D'ÉCLAIRAGE**

**CD127**

- Système de gestion d'éclairage conçu pour un montage dans les boîtiers des dispositifs encastrés.
- Convertit les actions manuelles d'un bouton poussoir conventionnel en commandes DALI.
- Possibilité de mémoriser un niveau d'éclairage défini à l'allumage.
- Plusieurs CD127 peuvent être connectés en parallèle pour créer plusieurs points de contrôle (jusqu'à 4 max.).
- Peut alimenter jusqu'à 25 drivers DALI.
- Longueur du câble de commande DALI max. 300m.

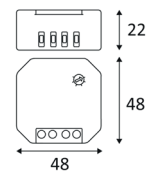

CODE	Watt Max	PRI	INPUTS	OUTPUTS	L (mm)	l (mm)	H (mm)	€
CD127	2W	AC 230V	1	1	48	48	22	251,30 B

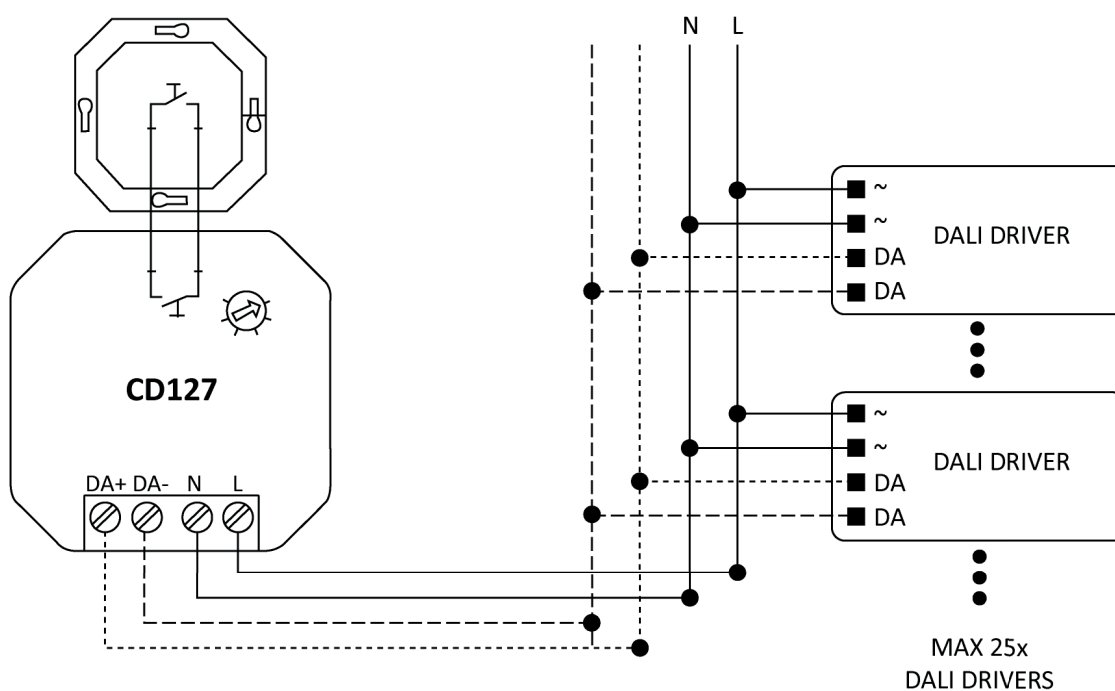

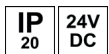
**CD136**

- Variateur tension constante à commander avec bouton poussoir ou télécommande.
- Convertisseur 24Vdc et télécommande à commander séparément.
- La télécommande permet de contrôler 4 zones séparément.  
Un variateur CD136 est nécessaire par zone à contrôler.

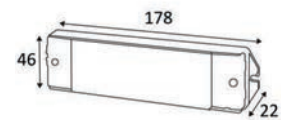

CODE	Watt Max	PRI	SEC	INPUTS	OUTPUTS	L (mm)	l (mm)	H (mm)	€
CD136	4x120W	DC 24V	DC 24V	2	4	178	46	22	163,80 B

ACCESSOIRES	DESCRIPTION	€
CD14905	TELECOMMANDE RF	62,80 B

# CD135



- Contrôleur RGB 24Vdc livré avec télécommande.
- Fonctions ON/OFF, pause, "mode", vitesse et intensité.
- Portée de la télécommande 25m.
- Convertisseur 24Vdc à commander séparément.

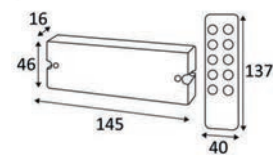

CODE	Watt Max	PRI	SEC	INPUTS	L (mm)	I (mm)	H (mm)	€
CD13505	3x120W	DC 24V	DC 24V	2	145	46	16	93,70 B

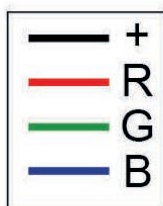
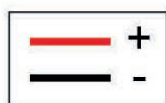
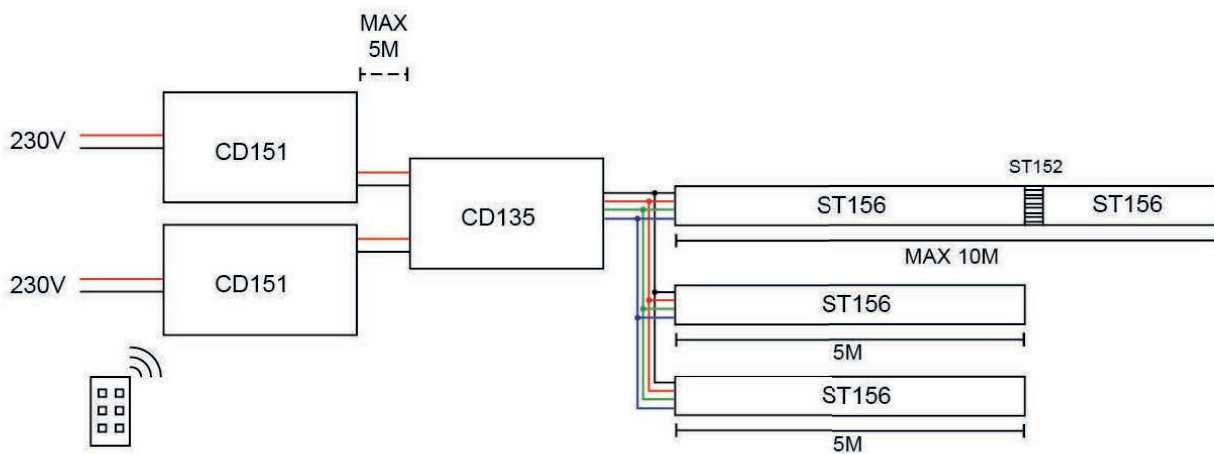
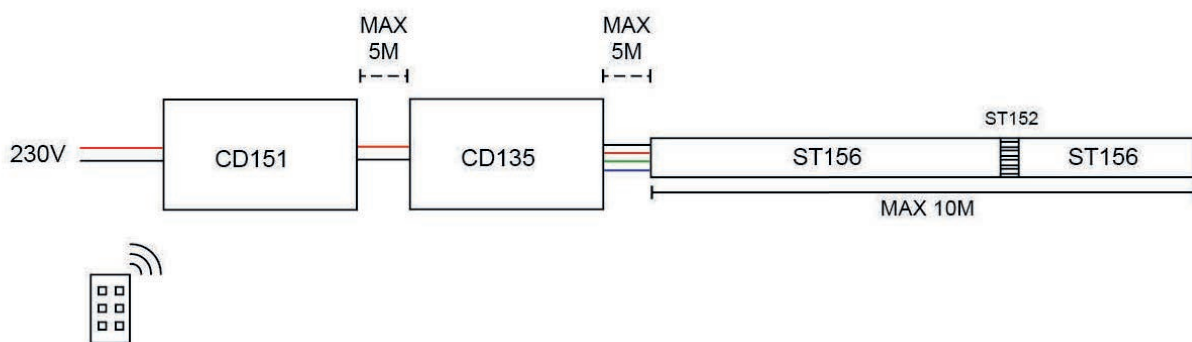





# CD141

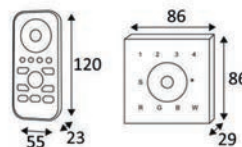
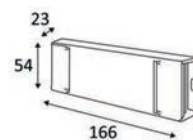

- Contrôleur RGB / RGB+W 24Vdc.
- Configuration "maître-esclave" suivant la position du switch.
- Convertisseur 24Vdc, télécommande ou panneau mural à commander séparément.
- Portée de la télécommande et du panneau mural 20m.



CODE	Watt Max	PRI	SEC	INPUTS	L (mm)	l (mm)	H (mm)	€
CD141	4x120W	DC 24V	DC 24V	2	166	54	23	170,00 B

ACCESSOIRES	DESCRIPTION	€
CD16005	TELECOMMANDE RF RGBW 	121,50 B
CD15704	PANNEAU MURAL RF RGBW 230V 	174,10 B

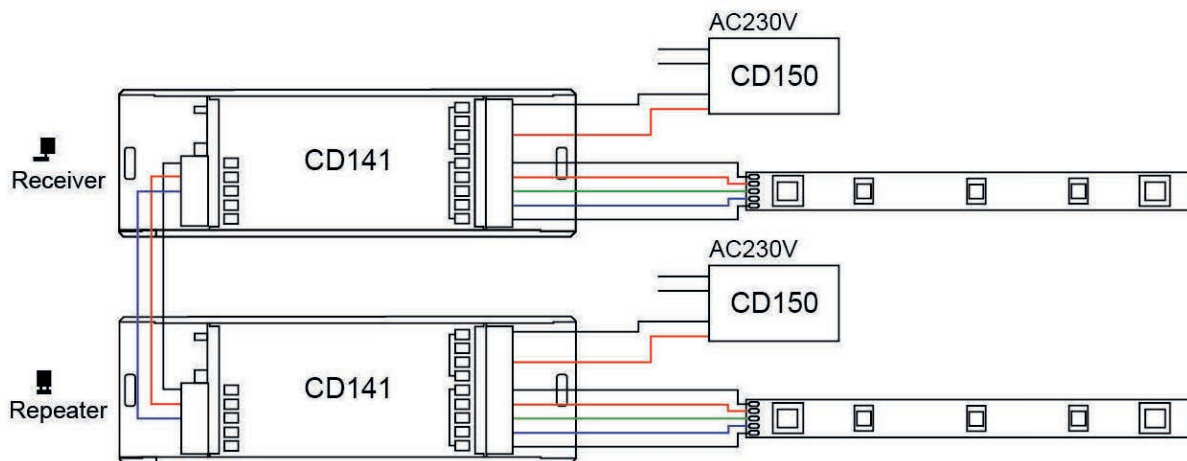

## C100924

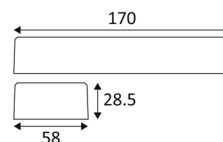

- Contrôleur et répéteurs de puissance RGB / RGBW 24VDC.
- Pour contrôler de 1 à 8 zones (1 contrôleur par zone).
- Le contrôleur C100924 reçoit le signal RF et le transmet aux répéteurs de puissance PR3011 et PR3002.
- Compatibles avec les produits 350mA et 24VDC.
- Utiliser le répéteur de puissance PR3011 avec les produits à courant constant (350mA) et le PR3002 avec les produits à tension constante (24VDC).
- Possibilité de raccorder jusqu'à 100 répéteurs de puissance par contrôleur.
- Convertisseurs 24VDC à commander séparément.
- Tous les contrôleurs et répéteurs de puissance nécessitent une tension d'entrée de 24VDC.
- Télécommande (6 zones), commande murale (4 zones) ou émetteur WiFi (8 zones) à commander séparément.
- Utiliser l'émetteur WiFi TR2818 (celui-ci nécessite une alimentation 24V 15W) pour contrôler l'installation avec l'application COLLINGWOOD depuis votre smartphone ou tablette.
- Le câble plat CF505RGBW permet de connecter les répéteurs de puissance PR3011 et PR3002 au contrôleur C100924.

CODE	Watt Max	PRI	SEC	INPUTS	OUTPUTS	€
<b>CONTROLEUR</b>						
<b>C100924</b> <span style="background-color: yellow;">NEW</span>		DC 24V	DC 24V	2	4x1A	<b>183,80</b> A
<b>REPETEUR DE PUISSANCE</b>						
<b>PR3011</b> <span style="background-color: yellow;">NEW</span>	4x8,4W	DC 24V	350mA		4x350mA	<b>108,20</b> A
<b>PR3002</b> <span style="background-color: yellow;">NEW</span>	4x39W	DC 24V	DC 24V		4x1,6A	<b>84,30</b> A

ACCESSOIRES	DESCRIPTION	L (mm)	€
<b>RC2819</b> <span style="background-color: yellow;">NEW</span>	TELECOMMANDE RF 6 ZONES RGB/RGBW	140	<b>201,30</b> A
<b>WC2820BLK</b> <span style="background-color: yellow;">NEW</span>	COMMANDE MURALE RF 4 ZONES RGB/RGBW 230V	86	<b>195,70</b> A
<b>WC2820WH</b> <span style="background-color: yellow;">NEW</span>	COMMANDE MURALE RF 4 ZONES RGB/RGBW 230V	86	<b>195,70</b> A
<b>TR2818</b> <span style="background-color: yellow;">NEW</span>	EMETTEUR WIFI RF 8 ZONES 24V	160	<b>136,70</b> A
<b>CF505RGBW</b> <span style="background-color: yellow;">NEW</span>	CABLE PLAT 4x0,3mm <sup>2</sup> -1x0,5mm <sup>2</sup> RGBW 1m		<b>4,00</b> A
<b>CD173</b> <span style="background-color: yellow;">NEW</span>	DRIVER 30W 24V CV	153	<b>37,80</b> A
<b>CD174</b> <span style="background-color: yellow;">NEW</span>	DRIVER 60W 24V CV	180	<b>45,40</b> A
<b>CD175</b> <span style="background-color: yellow;">NEW</span>	DRIVER 75W 24V CV	180	<b>46,70</b> A
<b>CD176</b> <span style="background-color: yellow;">NEW</span>	DRIVER 120W 24V CV	300	<b>58,50</b> A
<b>CD177</b> <span style="background-color: yellow;">NEW</span>	DRIVER 180W 24V CV	345	<b>121,70</b> A

### CD142



- Contrôleur blanc dynamique 24Vdc.
- Compatible avec bandeau LED ST132.
- Portée de la télécommande 25m.
- Convertisseur 24Vdc et télécommande à commander séparément.

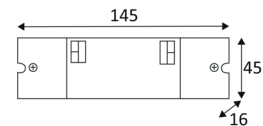

CODE	Watt Max	PRI	SEC	INPUTS	L (mm)	l (mm)	H (mm)	€
CD142	2x120W	DC 24V	DC 24V	1	145	45	16	70,00 B

ACCESSOIRES	DESCRIPTION	€
CD14305	TELECOMMANDE RF	55,60 B

### CD156



- Système de contrôle sans fil.
- Bluetooth.
- Commande via l'application CASAMBI.
- Contacts secs pour connecter un bouton poussoir.
- Possibilité de contrôler des bandeaux monochromes (dimming), RGB, RGBW ou blanc dynamique.
- Convertisseur 24Vdc à commander séparément.

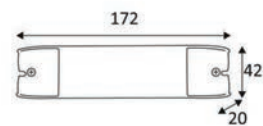

CODE	Watt Max	PRI	SEC	INPUTS	OUTPUTS	L (mm)	l (mm)	H (mm)	€
CD156	240W	DC 24V	DC 24V	1	1	172	42	20	445,00 B

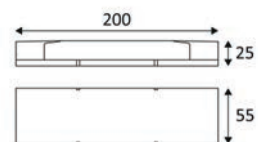
**LEDEP10**

- Kit d'éclairage de secours.
- Permet de convertir les luminaires compatibles en éclairage de secours.
- Test automatique (possibilité de test manuel via un bouton test fourni).
- Voyant bicolore rouge/vert indiquant le statut de l'installation.
- Autonomie minimale de 3 heures.
- Diamètre d'encastrement : 18mm (voyant LED), 7mm (bouton test).
- Connecteurs Plug & Play.
- Compatible avec les produits THEA, SOLIS et DOMINO.

CODE	Watt Max	L (mm)	l (mm)	H (mm)	€
LEDEP10 <b>NEW</b>	2,5W	200	55	25	233,10 A





# INDIGO



LIGHTING

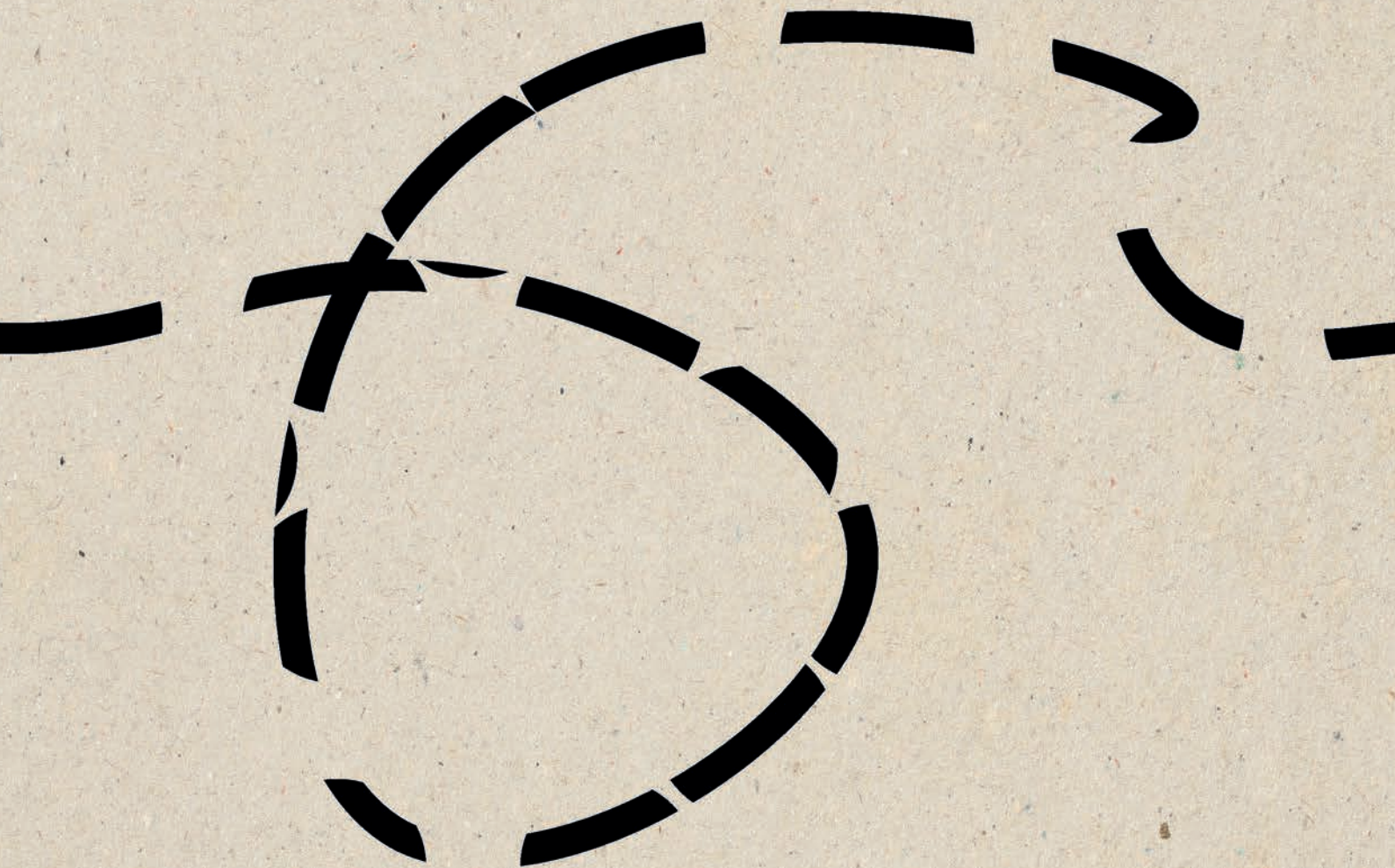

**CÂBLES**

**WCR275BLACK**

- Câble en caoutchouc 2 fils.
- H05RN-F 2x0,75mm<sup>2</sup>.
- Fourni au mètre.
- Limité à une utilisation en basse tension.
- Adapté à une utilisation en extérieur.

<b>WCR275BLACK</b>	€
<b>WCR275BLACK</b> <b>NEW</b>	8,80 A

**CF505RGBW**

- Câble plat RGBW 5 fils.
- 4x0,3mm<sup>2</sup>, 1x0,5mm<sup>2</sup>.
- Fourni au mètre.
- Permet de connecter un contrôleur RGBW C100924 à plusieurs répéteurs de puissance PR3002 et PR3011.

<b>CF505RGBW</b>	€
<b>CF505RGBW</b> <b>NEW</b>	4,00 A



**CR575RGBW****2**  
collingwood

- Câble PVC 5 fils.
- PVC 5x0,75mm<sup>2</sup>.
- Diamètre 7,4mm.
- Fourni au mètre.
- À utiliser pour rallonger le câble des produits RGBW.

<b>CR575RGBW</b>		€
CR575RGBW	<b>NEW</b>	5,00 A

**INDIGO**



**LIGHTING**

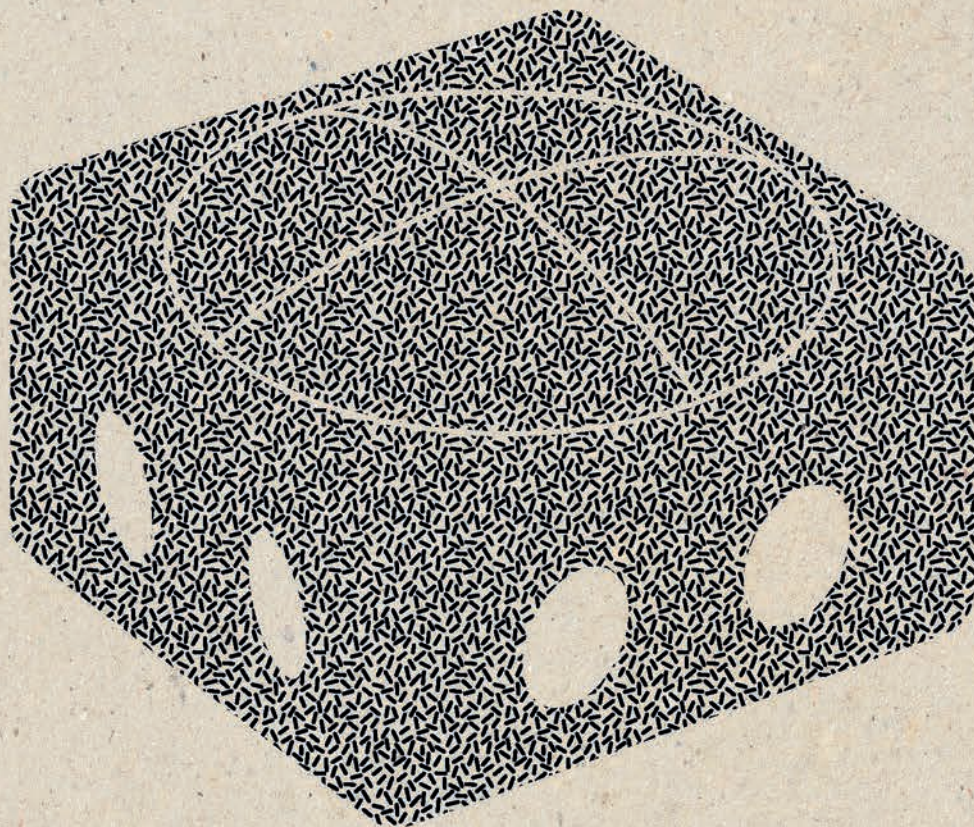

**BOÎTES DE RACCORDEMENT  
ET CONNECTEURS IP**

**WC59**

- Connecteur rapide étanche.
- Immergeable jusqu'à 9m.
- Doté d'une entrée et d'une sortie.
- Diamètre du câble compatible : 5 à 9mm. Conducteur de max 4mm<sup>2</sup>.
- Tension maximum : 250VAC / 50VDC.
- Courant maximum : 10A.
- Compatible avec le câble WCR275BLACK.

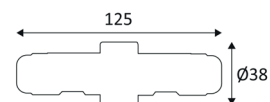

WC59		€
WC59	<b>NEW</b>	85,20 A

**JB1**

- Boîte de raccordement étanche.
- Pour le montage en parallèle de produits en extérieur.
- Dotée d'une entrée et de trois sorties.
- Une sortie peut être raccordée à une autre boîte JB1.
- Diamètre du câble compatible : 5 à 6,5mm. Conducteur de max 1mm<sup>2</sup>.
- Pour basse tension uniquement : max 30VDC.
- Courant maximum : 5A.

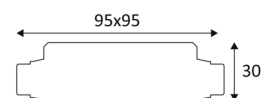

JB1		€
JB1	<b>NEW</b>	13,60 A

**JB2**

**IP**  
68

- Boîte de raccordement étanche.
- Pour le montage en série de produits en extérieur.
- Dotée d'une entrée et de trois sorties.
- Une sortie peut être raccordée à une autre boîte JB2.
- Diamètre du câble compatible : 5 à 6,5mm.  
Conducteur de max 1mm<sup>2</sup>.
- Pour basse tension uniquement : max 48VDC.
- Courant maximum : 700mA.

  
collingwood

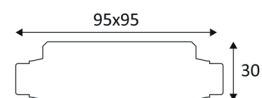

JB2		€
JB2	<b>NEW</b>	13,60 A

**JB3**

**IP**  
66

- Boîte de raccordement étanche.
- Pour le montage en parallèle de produits en extérieur.
- Dotée d'une entrée, de sept sorties et comprenant un bornier à 5 pôles.
- Diamètre du câble compatible : 3 à 12mm.  
Conducteur de max 4mm<sup>2</sup>.
- Tension maximum : 400VAC.
- Courant maximum : 30A.

  
collingwood

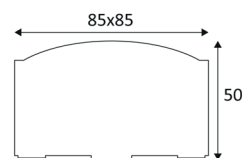

JB3		€
JB3	<b>NEW</b>	24,70 A

**JB4**

- Boîte de connexion étanche siliconée.
- Pour le montage en série de produits en extérieur.
- Dotée d'une entrée et de trois sorties.
- Diamètre du câble compatible : 6,5 à 12mm.  
Conducteur de max 1,5mm<sup>2</sup>.
- Tension maximum : 120VDC.
- Courant maximum : 700mA.

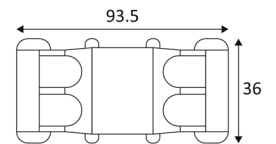

JB4	€
JB4 <b>NEW</b>	54,70 A

**JB5**

- Boîte de connexion étanche siliconée.
- Pour le montage en parallèle de produits en extérieur.
- Dotée d'une entrée et de trois sorties.
- Diamètre du câble compatible : 6,5 à 12mm.  
Conducteur de max 1,5mm<sup>2</sup>.
- Tension maximum : 250VAC.
- Courant maximum : 16A.

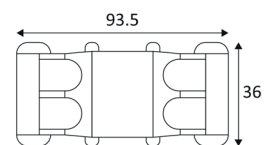

JB5	€
JB5 <b>NEW</b>	54,70 A

**JB6**
**IP**  
68

- Connecteur étanche siliconé.
- Pour connexion filaire continue en extérieur.
- Doté d'une entrée et d'une sortie.
- Diamètre du câble compatible : 4,8 à 6mm.
- Conducteur de max 0,75mm<sup>2</sup>.
- Tension maximum : 250VAC.
- Courant maximum : 6A.

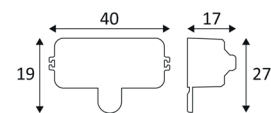

JB6	€
JB6	<b>NEW</b> 29,60 A

**JB7**
**IP**  
68

- Connecteur étanche 5 bornes à visser.
- Pour le montage de produits RGBW uniquement, en extérieur.
- Doté d'une entrée et d'une sortie.
- Diamètre du câble compatible : 7 à 10,5mm.
- Conducteur de max 4mm<sup>2</sup>.
- Tension maximum : 24V.
- Courant maximum : 1,4A.

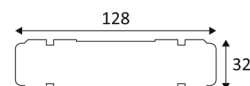

JB7	€
JB7	<b>NEW</b> 42,60 A

**INDIGO**



**LIGHTING**



**PICTOGRAMMES**



**INDEX Collingwood**

**INDEX GÉNÉRAL**

	Usage extérieur.		Le produit ne peut pas être recouvert après montage, même par un isolant.
	Usage intérieur et extérieur.		Le produit peut être recouvert après montage par un isolant déroulé.
	Montage au plafond en encastré uniquement.		Le produit peut être recouvert après montage par un isolant déroulé ou soufflé.
	Montage au plafond en encastré uniquement.		<b>IP 20</b> Protection contre la pénétration de corps supérieurs à 12mm. Sans protection contre l'eau.
	Montage au plafond uniquement.		<b>IP 23</b> Protection contre les pénétrations des corps solides supérieurs à 12mm. Protection contre les chutes verticales de gouttes d'eau avec angle d'inclinaison de max. 60°.
	Montage sur un mur ou un plafond.		<b>IP 33</b> Protection contre les pénétrations des corps solides supérieurs à 2,5mm. Protection contre les chutes verticales de gouttes d'eau avec angle d'inclinaison de max. 60°.
	Montage en suspension.		<b>IP 40</b> Protection contre la pénétration des corps solides supérieurs à 1mm. Sans protection contre l'eau.
	Montage en suspension.		<b>IP 44</b> Protection contre la pénétration des corps solides supérieurs à 1mm. Protection contre les projections d'eau.
	Montage sur un mur en encastré uniquement.		<b>IP 54</b> Protection contre les poussières et contre les projections d'eau.
	Montage sur un mur en encastré uniquement.		<b>IP 55</b> Protection contre la poussière. Protection contre les jets d'eau.
	Montage sur un mur uniquement.		<b>IP 56</b> Protection contre la poussière. Protection contre les jets d'eau.
	Montage sur un mur uniquement.		<b>IP 65</b> Etanchéité aux poussières. Protection contre les jets d'eau.
	Montage sur un mur uniquement.		<b>IP 66</b> Etanchéité aux poussières. Etanchéité aux jets d'eau puissants.
	Montage sur un mur uniquement.		<b>IP 67</b> Etanche aux poussières. Etanche à l'immersion temporaire.
	Montage sur un mur uniquement.		<b>IP 68</b> Totalement protégé contre les poussières. Protégé contre les effets prolongés de l'immersion sous pression à 2m.
	Montage sur un mur uniquement. Ce luminaire éclaire avec 2 zones d'éclairage.		<b>IK 00</b> Pas de protection.
	Montage sur un mur uniquement. Ce luminaire éclaire avec 2 zones d'éclairage.		<b>IK 01</b> Protection contre une énergie de choc de 0,15 Joule.
	Montage dans le sol en encastré uniquement.		<b>IK 02</b> Protection contre une énergie de choc de 0,20 Joule.
	Montage dans le sol en encastré uniquement.		<b>IK 03</b> Protection contre une énergie de choc de 0,35 Joule.
	Montage sur le sol en apparent uniquement.		<b>IK 04</b> Protection contre une énergie de choc de 0,50 Joule.
	Montage sur le sol uniquement.		<b>IK 05</b> Protection contre une énergie de choc de 0,70 Joule.
	Montage sur le sol uniquement.		<b>IK 06</b> Protection contre une énergie de choc de 1 Joule.
	Montage sur le sol uniquement.		<b>IK 07</b> Protection contre une énergie de choc de 2 Joules.
	Luminaire mobile.		<b>IK 08</b> Protection contre une énergie de choc de 5 Joules.
	Produit à isolation principale qui comporte des dispositifs reliant l'ensemble de ses parties métalliques accessibles au conducteur de protection.		<b>IK 09</b> Protection contre une énergie de choc de 10 Joules.
	Produit dont les parties accessibles sont séparées des parties actives par double isolation ou isolation renforcée.		<b>IK 10</b> Protection contre une énergie de choc de 20 Joules.
	Produit alimenté sous une très basse tension de sécurité (T.B.T.S) qui n'excède pas 50V (valeur efficace en courant alternatif).		<b>IK 11</b> Protection contre une énergie de choc de 50 Joules.
	Conforme à la réglementation thermique en vigueur (France).		Anti-vandale.
			

	Inox 304. Nettoyer régulièrement avec un produit adapté pour éviter toute corrosion. Pas d'agent mordant ni de matériau abrasif.		Livré avec lampe(s).
	Inox 316. Nettoyer régulièrement avec un produit adapté pour éviter toute corrosion. Pas d'agent mordant ni de matériau abrasif.		Avec prise USB.
	Testé à 650°.		Batterie rechargeable via prise USB.
	Testé à 750°.		Avec détecteur de mouvement.
	Testé à 850°.		Avec cellules solaires.
	Indice de rendu des couleurs >70.		Dimmable, avec variateur intégré.
	Indice de rendu des couleurs >80.		Le produit est dimmable.
	Indice de rendu des couleurs >85.		Le produit est dimmable (0-10V).
	Indice de rendu des couleurs >90.		Le produit est dimmable (1-10V).
	Indice de rendu des couleurs >95.		Le produit est dimmable (entrée DALI).
	A connecter à un courant alternatif de 12V.		Le produit est dimmable (entrée DALI + push-dim).
	A connecter à un courant alternatif de 230V.		Température de couleur variable de 1800K à 3000K suivant l'intensité de dimming.
	A connecter à une alimentation Led en voltage constant de 12VDC.		Température de couleur variable de 2000K à 3000K suivant l'intensité de dimming.
	A connecter à une alimentation Led en voltage constant de 24VDC.		Température de couleur à sélectionner.
	A connecter à une alimentation Led en voltage constant de 48VDC.		Température de couleur à sélectionner.
	Luminaire équipé d'un module LED en 230V.		Température de couleur à sélectionner.
	Alimentation non incluse.		Température de couleur à sélectionner.
	Branchement en parallèle.		Température de couleur à sélectionner.
	Branchement en série.		Température de couleur à sélectionner.
	Avec prises 2P + T 16A max. 2x2000W.		Blanc dynamique (2700K-6000K).
	UGR inférieur à 19.		Changement de couleur RGB.
	Orientation verticale possible du luminaire pour un maximum de x°.		RGB + White.
	Orientation horizontale possible du luminaire pour un maximum de x°.		Durée de vie (maintien du flux lumineux L et taux de mortalité B).
	Percement rectangulaire pour l'insertion du luminaire. La longueur et la largeur à respecter sont citées dans la fiche technique et le manuel de montage (mm).		Garantie 2 ans.
	Diamètre de percement pour l'insertion du boîtier du luminaire (mm).		Garantie 3 ans.
	Hauteur de faux-plafond minimum pour y inclure le luminaire (mm).		Garantie 5 ans.
	Largeur de faisceau.		Garantie 7 ans.
	Faisceau ajustable.		Garantie 8 ans.





0 1 2 3 4 5 6 7 8 9 10 11 12 13 14 15 16 17 18 19 20 21 22 23 24 25 26 27 28





28  
27  
26  
25  
24  
23  
22  
21  
20  
19  
18  
17  
16  
15  
14  
13  
12  
11  
10  
9  
8  
7  
6  
5  
4  
3  
2  
1  
0







28  
27  
26  
25  
24  
23  
22  
21  
20  
19  
18  
17  
16  
15  
14  
13  
12  
11  
10  
9  
8  
7  
6  
5  
4  
3  
2  
1  
0

**B**

BOL201X30 ..... 479

**C**

C100924 ..... 424,  
425,  
426,  
427,  
428,  
429,  
519,  
521,  
553,  
592,  
593,  
632  
CF505RGBW ..... 632,  
638  
CR575RGBW ..... 519,  
521,  
639

**D**

DL5485500 ..... 50  
DLCONVERT70BS ..... 50, 51  
DLCONVERT70CR ..... 50, 51  
DLCONVERT70MW ..... 50, 51  
DLCONVERT70WH ..... 50, 51  
DLCVT110BLK ..... 50, 51  
DLCVT110BS ..... 50, 51  
DLCVT110MW ..... 50, 51  
DLCVT110WH ..... 50, 51  
DLT551500A ..... 51  
DMB66N4K ..... 148,  
149  
DMB66X4K ..... 148  
DMW66N4K ..... 148,  
149  
DMW66X4K ..... 148

**G**

GH220B ..... 448,  
449,  
450,  
451,  
452,  
453,  
522  
GH220D ..... 448,  
449,  
450,  
451,  
453,  
522  
GH220Z ..... 448,  
449,  
450,  
451,  
452,  
453,  
522  
GL008RGBW ..... 424,  
425  
GL016BC0F27 ..... 415  
GL016BC0F30 ..... 415  
GL016BC0F40 ..... 415  
GL016BMBX27 ..... 413  
GL016BMBX30 ..... 413  
GL016BMBX40 ..... 413  
GL016BMBXBL ..... 413  
GL016DC0F27 ..... 415  
GL016DC0F30 ..... 415  
GL016DC0F40 ..... 415  
GL016F27 ..... 413  
GL016FAB27 ..... 413  
GL016FABNW ..... 413  
GL016FABWW ..... 413  
GL016FBLUE ..... 413  
GL016FNNW ..... 413  
GL016FVW ..... 413  
GL016RGBW ..... 428  
GL016SQ27 ..... 414  
GL016SQNW ..... 414  
GL016SQWW ..... 414  
GL018C27 ..... 422  
GL018CAB27 ..... 422

**G**

GL018CABNW ..... 422  
GL018CABWW ..... 422  
GL018CBLUE ..... 422  
GL018CNW ..... 422  
GL018CWW ..... 422  
GL018SQWW ..... 423  
GL019ANBX27 ..... 409  
GL019ANBX30 ..... 409  
GL019AWBX27 ..... 409  
GL019AWBX30 ..... 409  
GL019BC0F27 ..... 411  
GL019BC0F30 ..... 411  
GL019BC0F40 ..... 411  
GL019BNBX27 ..... 409  
GL019BNBX30 ..... 409  
GL019BNBX40 ..... 409  
GL019BNBXBL ..... 409  
GL019BWBX27 ..... 409  
GL019BWBX30 ..... 409  
GL019BWBX40 ..... 409  
GL019BWBXBL ..... 409  
GL019DC0F27 ..... 411  
GL019DC0F30 ..... 411  
GL019DC0F40 ..... 411  
GL019DC0FBL ..... 411  
GL019DMBL27 ..... 410  
GL019DMBL30 ..... 410  
GL019DNBL27 ..... 410  
GL019DNBL30 ..... 410  
GL019E27BL ..... 488  
GL019E27SS ..... 488  
GL019E30BL ..... 488  
GL019E30SS ..... 488  
GL019F27 ..... 409  
GL019FAMBER ..... 409  
GL019FBLUE ..... 409  
GL019FNW ..... 409  
GL019FRED ..... 409  
GL019FWW ..... 409  
GL019LGF27 ..... 410  
GL019LGFNW ..... 410  
GL019LGFVW ..... 410  
GL019LGS27 ..... 410  
GL019LGSWW ..... 410  
GL019S27 ..... 409  
GL019SNW ..... 409  
GL019SQFNW ..... 412  
GL019SQFVW ..... 412  
GL019SFWW ..... 409  
GL02127 ..... 486  
GL021NW ..... 486  
GL021WW ..... 486  
GL02227 ..... 487  
GL022NW ..... 487  
GL022WW ..... 487  
GL034DWBM27 ..... 489  
GL034DWBM30 ..... 489  
GL034DWBM40 ..... 489  
GL038AWBM27 ..... 408  
GL038AWBM30 ..... 408  
GL038DWBM27 ..... 408  
GL038DWBM30 ..... 408  
GL038DWBM40 ..... 408  
GL040AMBL27 ..... 407  
GL040AMBL30 ..... 407  
GL040ANBL27 ..... 407  
GL040ANBL30 ..... 407  
GL040ANBL40 ..... 407  
GL040ANBX27 ..... 406  
GL040ANBX30 ..... 406  
GL040AWBX27 ..... 406  
GL040AWBX30 ..... 406  
GL040CARGB ..... 427  
GL040DMBL27 ..... 407  
GL040DMBL30 ..... 407  
GL040DMBL40 ..... 407  
GL040DNBL27 ..... 407

**G**

GL040DNBL30 ..... 407  
GL040DNBX27 ..... 406  
GL040DNBX30 ..... 406  
GL040DNBX40 ..... 406  
GL040DWBX27 ..... 406  
GL040DWBX30 ..... 406  
GL040DWBX40 ..... 406  
GL045X30 ..... 405  
GL05027 ..... 420,  
421  
GL050BLUE ..... 420,  
421  
GL050NW ..... 420,  
421  
GL050RGBW ..... 429  
GL050WW ..... 420,  
421  
GL063 ..... 416  
GL064 ..... 417  
GL06X30 ..... 405  
GL07D24X30 ..... 404  
GL07D24X40 ..... 404  
GL07D38X30 ..... 404  
GL07D38X40 ..... 404  
GL07D60X30 ..... 404  
GL07D60X40 ..... 404  
GL08D24X30 ..... 403  
GL08D38X30 ..... 403  
GL08D60X30 ..... 403  
GL090RGBW ..... 426  
GL09D38X30 ..... 402,  
403  
GL09D60X30 ..... 402,  
403  
GL100AX1X27 ..... 418  
GL100AX1X30 ..... 418  
GL100AX2127 ..... 418  
GL100AX2130 ..... 418  
GL100AX2227 ..... 418  
GL100AX2230 ..... 418  
GL100AX3X27 ..... 418  
GL100AX3X30 ..... 418  
GL100AX4X27 ..... 418  
GL100AX4X30 ..... 418  
GL100DX1X27 ..... 418  
GL100DX1X30 ..... 418  
GL100DX2127 ..... 418  
GL100DX2130 ..... 418  
GL100DX2140 ..... 418  
GL100DX2227 ..... 418  
GL100DX2230 ..... 418  
GL100DX2240 ..... 418  
GL100DX3X27 ..... 418  
GL100DX3X30 ..... 418  
GL100DX4X27 ..... 418  
GL100DX4X30 ..... 418  
GL200AX1X30 ..... 419  
GL200AX2130 ..... 419  
GL200AX2230 ..... 419  
GL200AX3X30 ..... 419  
GL200AX4X30 ..... 419  
GL200DX1X27 ..... 419  
GL200DX1X30 ..... 419  
GL200DX1X40 ..... 419  
GL200DX2127 ..... 419  
GL200DX2130 ..... 419  
GL200DX2140 ..... 419  
GL200DX2227 ..... 419  
GL200DX2230 ..... 419  
GL200DX2240 ..... 419  
GL200DX3X27 ..... 419  
GL200DX3X30 ..... 419  
GL200DX4X27 ..... 419  
GL200DX4X30 ..... 419  
GL200DX4X40 ..... 419

### G

GLA01 .....	406, 407, 420, 421, 426, 427, 429
GS220B .....	448, 449, 450, 451, 452, 453, 522
GS220D .....	448, 449, 450, 451, 453, 522
GS220Z .....	448, 449, 450, 451, 452, 453, 522

### H

HBASDHSRC .....	380
-----------------	-----

### J

JB1 .....	422, 423, 454, 642
JB2 .....	406, 407, 409, 410, 411, 412, 413, 414, 415, 416, 417, 418, 420, 421, 446, 447, 448, 450, 452, 455, 486, 487, 488, 518, 520, 643
JB3 .....	592, 593, 643
JB4 .....	406, 407, 409, 410, 411, 412, 413, 414, 415, 416, 417, 418, 420, 421, 446, 447, 448, 450, 452, 455, 486, 487, 488, 518, 520, 644

### J

JB5 .....	402, 403, 404, 405, 408, 419, 422, 423, 449, 451, 453, 454, 479, 489, 492, 493, 644
JB6 .....	406, 407, 409, 410, 411, 412, 413, 414, 415, 416, 417, 418, 420, 421, 422, 423, 446, 447, 448, 450, 452, 454, 455, 486, 487, 488, 518, 520, 645
JB7 .....	424, 425, 426, 427, 428, 429, 519, 521, 645

<b>L</b>	
LB10040 .....	380
LB15040 .....	380
LBACM .....	380
LBAL5090 .....	380
LBASDHS .....	380
LEDEP10 .....	122, 123, 128, 129, 144, 145, 146, 147, 148, 149, 634
LEDRGBWEXT .....	553

<b>M</b>	
MC010S27 .....	542
MC010SWW .....	542
MC020S27 .....	542
MF02IP27 .....	516, 517
MF02IPNW .....	516, 517
ML0127 .....	484
ML01NW .....	484
ML01WW .....	484
ML0227 .....	484, 485
ML02NW .....	484, 485

### N

NV45UPM .....	228, 250
NV60UPM .....	228, 250
NV90UPM .....	229, 251
NVB45DS .....	228
NVB60DS .....	228
NVB90DS .....	229
NVW45DS .....	228
NVW60DS .....	228
NVW90DS .....	229

<b>P</b>	
P1SK .....	144, 145
P1SKC .....	145
P2A16S30WA .....	144
P2A16X30WA .....	144
P2A19S40WA .....	144
P2A19X40WA .....	144
P2B16S30WA .....	145
P2B16X30WA .....	145
P2C19S60WA .....	145
P2C19X60WA .....	145
P2SMA .....	144, 146, 147
P2SMB .....	145
P2SMC .....	145
PLDUNIDRIVE350MA .....	622
PLDUNIDRIVE700MA .....	622
PLR35015 .....	484, 485, 486, 487, 516, 517, 542, 622
PLU35019 .....	484, 485, 486, 487, 516, 517, 542, 622
PLU70039 .....	622
PLUPP35019 .....	622
POL112N .....	376, 377
POL115N .....	376, 377
POL212N .....	376, 377
POL215N .....	376, 377
PR3002 .....	632
PR3011 .....	424, 425, 426, 427, 428, 429, 519, 521, 553, 592, 593, 632
PS250600MA .....	122, 123
PS6501100MA .....	144, 145, 146, 148
PSDAL350M .....	623
PSDAL700M .....	136, 137, 623
PSDIM350 .....	622
PSDIM700 .....	622

**P**

PSIP35018W ..... 406, 407, 409, 410, 411, 412, 413, 414, 415, 416, 417, 418, 420, 421, 446, 447, 448, 450, 452, 484, 485, 486, 487, 488, 516, 517, 542, 622  
 PSIP3509W ..... 406, 407, 409, 410, 411, 412, 413, 414, 415, 416, 417, 418, 420, 421, 446, 447, 448, 450, 452, 484, 485, 486, 487, 488, 516, 517, 542, 622  
 PSIP70018W ..... 406, 409, 412, 413, 414, 418, 446, 447, 448, 450, 452, 455, 488, 518, 520, 622  
 PSIP70036W ..... 406, 409, 412, 413, 414, 418, 446, 447, 448, 450, 452, 455, 488, 518, 520, 622  
 PSMD3501324 ..... 623  
 PSMD35039 ..... 623  
 PSMD70024 ..... 623

**P**

PSMD700610 ..... 623

**R**

RB359BLK ..... 50, 51  
 RB359BS ..... 50, 51  
 RB359CR ..... 50, 51  
 RB359MW ..... 50, 51  
 RB359PG ..... 50, 51  
 RB359SIL ..... 50, 51  
 RB359WH ..... 50, 51  
 RC2819 ..... 632

**S**

SL030F27 ..... 446, 447  
 SL030FNW ..... 446, 447  
 SL030FWW ..... 446, 447  
 SL040AF27 ..... 455  
 SL040AFWW ..... 455  
 SL040AS27 ..... 455  
 SL040ASWW ..... 455  
 SL13027 ..... 446, 447  
 SL13030 ..... 446, 447  
 SL130ZMBX27 ..... 446, 447  
 SL130ZMBX30 ..... 446, 447  
 SL220BNBX27 ..... 448  
 SL220BNBX30 ..... 448  
 SL220BWBX27 ..... 449  
 SL220BWBX30 ..... 449  
 SL220BWBX27 ..... 448  
 SL220BWBX30 ..... 448  
 SL220CWBM27 ..... 449  
 SL220CWBX27 ..... 448  
 SL220DWBM27 ..... 449  
 SL220DWBM30 ..... 449  
 SL220DWBX27 ..... 448  
 SL220DWBX30 ..... 448  
 SL220ZWBX27 ..... 449  
 SL220ZWBX30 ..... 449  
 SL220ZWBX27 ..... 448  
 SL220ZWBX30 ..... 448  
 SL230BWBX27 ..... 451  
 SL230BWBX30 ..... 451  
 SL230BWBX27 ..... 450  
 SL230BWBX30 ..... 450  
 SL230DWBM27 ..... 451  
 SL230DWBM30 ..... 451  
 SL230DWBX30 ..... 450  
 SL230ZWBX27 ..... 450  
 SL230ZWBX30 ..... 450  
 SL240BWBX27 ..... 453  
 SL240BWBX30 ..... 453  
 SL240BWBX27 ..... 452  
 SL240BWBX30 ..... 452  
 SL240DWBM30 ..... 453  
 SL240DWBM30 ..... 453  
 SL240ZWBX27 ..... 453  
 SL240ZWBX30 ..... 453  
 SL240ZWBX27 ..... 452  
 SL240ZWBX30 ..... 452  
 SL250A1 ..... 454  
 SL250ATX0X27 ..... 454  
 SL250ATX0X30 ..... 454  
 SL250BPX0X27 ..... 454  
 SL250BPX0X30 ..... 454  
 SOLIP66N4K ..... 146  
 SOLP66N4K ..... 147  
 SOLP66X4K ..... 146  
 SQB360BLK ..... 50, 51  
 SQB360MW ..... 50, 51  
 SU17036 ..... 250  
 SU17080 ..... 250  
 SU17136 ..... 250  
 SU17180 ..... 250

**S**

SU17236 ..... 251  
 SU17280 ..... 251

**T**

THL1N ..... 122  
 THL1X ..... 122  
 THL2N ..... 123  
 THL2X ..... 123  
 THL3N ..... 123  
 THL3X ..... 123  
 THP12UGR ..... 128  
 THP1DD ..... 128  
 THP1N ..... 128  
 THP1X ..... 128  
 THP23DD ..... 128, 129  
 THP2N ..... 128  
 THP2X ..... 128  
 THP34UGR ..... 129  
 THP3N ..... 129  
 THP3X ..... 129  
 THP4DD ..... 129  
 THP4N ..... 129  
 THP4X ..... 129  
 TR28000677 ..... 145  
 TR2818 ..... 632  
 TUBE332 ..... 409, 410, 411, 412, 418, 488  
 TUBE50 ..... 413, 414, 415, 428, 486, 487  
 TUBE68 ..... 406, 407, 416, 417, 419, 420, 421, 426, 427, 429

**U**

UL01027 ..... 518  
 UL010A27 ..... 518  
 UL010AWW ..... 518  
 UL010NW ..... 518  
 UL010RGBW ..... 519  
 UL010WW ..... 518  
 UL030ANAX27 ..... 520  
 UL030ANAX30 ..... 520  
 UL030AWAX27 ..... 520  
 UL030AWAX30 ..... 520  
 UL030BWBX27 ..... 520  
 UL030BWBX30 ..... 520  
 UL030DNBX27 ..... 520  
 UL030DNBX30 ..... 520  
 UL030DNBX40 ..... 520  
 UL030DWBX27 ..... 520  
 UL030DWBX30 ..... 520  
 UL030DWBX40 ..... 520  
 UL030RGBW ..... 521  
 UL345CARGB ..... 592, 593  
 UL346CARGB ..... 592, 593  
 UL347CARGB ..... 592, 593

**W**

WBM01 ..... 516, 517  
 WBM02 ..... 516, 517  
 WC2820BLK ..... 632  
 WC2820WH ..... 632

**W**

WC59 .....	402, 403, 404, 405, 408, 419, 489, 492, 493, 642
WCR275BLACK .....	413, 414, 415, 416, 417, 420, 421, 446, 447, 454, 455, 486, 487, 518, 520, 638
WL041IPNW .....	513
WL041IPWW .....	513
WL060NW .....	534
WL060WW .....	534
WL070BNBM27 .....	552
WL070BNBM30 .....	552
WL070CNBM27 .....	552
WL070CNBM30 .....	552
WL070RGBW .....	553
WL070SNBM27 .....	552
WL070SNBM30 .....	552
WL070ZNB27 .....	552
WL070ZNB30 .....	552
WL075BNBM27 .....	523
WL075BNBM30 .....	523
WL075SNBM27 .....	523
WL075SNBM30 .....	523
WL075ZNB27 .....	523
WL075ZNB30 .....	523
WL16027 .....	534
WL160NW .....	534
WL160WW .....	534
WL220BWB27 .....	522
WL220BWB30 .....	522
WL220CWBM27 .....	522
WL220DWBM27 .....	522
WL220DWBM30 .....	522
WL220ZWB27 .....	522
WL220ZWB30 .....	522
WL339WW .....	492
WL340AB27 .....	492
WL340ABWW .....	492
WL340WW .....	492
WL341WW .....	492, 493
WL342AB27 .....	492, 493
WL342AB30 .....	492, 493
WL342WW .....	492, 493
WL9410CCS .....	372
WL9410ECS .....	372
WL9410MCS .....	372
WL9410SCS .....	372
WL9418CCS .....	372
WL9418MCS .....	372
WL9418SCS .....	372

..... 624

**A**

ABY 1 RD ..... 74

ABY 2 RD ..... 75

ABY 3 RD ..... 75

ADA 1 RX ..... 588

ADA 2 RX ..... 588, 589

ADES ..... 596, 597

AKIS R GU10 ..... 94, 95

AL1014 ..... 60

AL1014 RDX ..... 60

AL1014 RX ..... 60

AL1015 ..... 80

AL1015 RX ..... 80

AL1015 SX ..... 80, 81

AL1016 RX ..... 136, 137

AL2014 SDX ..... 61

AL3012 RD ..... 72

AL3012 RD OUT ..... 586, 587

AL3012 RD WARM ..... 72

ALA1013 ..... 26, 27

ALA1013 RX GU10 AUTO ..... 26, 27

ALA1013 SX GU10 AUTO ..... 26, 27

ALA1013S ..... 26, 27

ALBA R GU10 ..... 194

ALBA S GU10 ..... 195

ALEX RDX ..... 58, 59

ALIS 1014 RDX ..... 61

ALLY 1 RDX ..... 100, 101

ALLY 1 RX ..... 100, 101

ALLY 2 RDX ..... 102, 103

ALLY 2 RX ..... 102, 103

ALLY 3 RDX ..... 79

ALLY 4 RDX ..... 79

ALMA R ..... 543

ALMA S ..... 543

ALTEA 1 GU10 ..... 501

ALTEA 2 GU10 ..... 501

ALTO 1 GU10 ..... 500

ALTO 2 GU10 ..... 500

AMONT ..... 470

ANDY ..... 445

APA RD-230 ..... 397

ARCOLE ..... 525

ARRAS ..... 347

ARTSY ..... 495

ASPI 1 SENSOR PLUS ..... 570

ASPI 2 SENSOR PLUS ..... 571

AUREA 1 C ..... 218, 219

AUREA 1 W ..... 166, 167

AUREA 2 C ..... 219

AUREA 2 W ..... 167

AUREA 3 T ..... 310

AUREA 3 TP ..... 310, 311

AUREA 3 W ..... 168

AUREA 4 W ..... 168, 169

AUREA P ..... 244

AVI 1 ..... 476

AVI 2 ..... 476

**B**

BALI R GU10 ..... 30

BALTI A ..... 533

BASEKC211R25 ..... 41

BASEKC211R30 ..... 41

BASIL 1 P ..... 436

BASIL 2 P ..... 436

BASIL 3 P ..... 437

**B**

BENS P ..... 474, 475

BENS W ..... 527

BERN ..... 348, 349

BETSY 1 ..... 174

BETSY 2 ..... 175

BIG APA RD-230 ..... 397

BIG RODI A ..... 400, 401

BIXBY ..... 184, 185

BO1360A15 ..... 503

BOL201 ..... 479

BORA RDX ..... 57

BORA RDX-230 ..... 56

BORA SDX ..... 57

BP1 ..... 528

BP12/1D/3K/A ..... 528

BP12/1D/3K/BR ..... 528

BP12/1D/3K/G ..... 528

BP12/2D/3K/A ..... 528, 529

BP12/2D/3K/BR ..... 528, 529

BP12/2D/3K/W ..... 528, 529

BP1A ..... 530

BP2 ..... 528, 529

BP22/1C/3K/A ..... 530

BP22/1C/3K/BR ..... 530

BP22/1C/3K/W ..... 530

BP22/2C/3K/A ..... 530, 531

BP22/2C/3K/G ..... 530, 531

BP22/2C/3K/W ..... 530, 531

BP2A ..... 530, 531

BRAMA 1 ..... 440

BRAMA 2 ..... 440, 441

BRAVA RD-230 ..... 48

BRAVA RDH-230 ..... 49

BREST ..... 471

BRIKPRO 1 ..... 528

BRIKPRO 1 A ..... 530

BRIKPRO 2 ..... 528, 529

BRIKPRO 2 A ..... 530, 531

BU101 ..... 368, 369

BU102 ..... 368

BU103 ..... 370

BU104 ..... 370, 371

**C**

C100924 ..... 424, 425, 426, 427, 428, 429, 519, 521, 553, 592, 593

C100924 ..... 632

CADIX ..... 346

CAPRI R 1 C ..... 230

CAPRI R 1 P ..... 252

CAPRI R 2 C ..... 231

CAPRI R 2 P ..... 252

CAPRI R 3 C ..... 231

CAPRI R 3 P ..... 253

CAPRI S 1 C ..... 232

CAPRI S 1 P ..... 254

CAPRI S 2 C ..... 232, 233

**C**

CAPRI S 2 P ..... 254, 255

CD102 ..... 623

CD104 ..... 623

CD105 ..... 394, 490, 491

CD105 ..... 622

CD112 ..... 623

CD114 ..... 393

CD114 ..... 622

CD116 ..... 622, 623

CD122 ..... 622, 623

CD123 ..... 79, 100, 101, 108, 126

CD123 ..... 622, 623

CD124 ..... 104, 105

CD124 ..... 622, 623

CD125 ..... 110, 111

CD125 ..... 623

CD126 ..... 127

CD126 ..... 622, 623

CD127 ..... 82, 83, 231, 234, 235, 253, 256, 257

CD127 ..... 628

CD128 ..... 622

CD129 ..... 624

CD130 ..... 624

CD135 ..... 630

CD136 ..... 629

CD140 ..... 78, 79, 80, 81, 102, 103, 109, 127

CD140 ..... 622, 623

CD141 ..... 631

CD142 ..... 633

CD14305 ..... 633

CD144 ..... 335, 336

CD145 ..... 335, 336

CD146 ..... 335, 336

CD147 ..... 623

CD148 ..... 622, 623

CD14905 ..... 629

CD150 ..... 624

CD151 ..... 624

CD152 ..... 624

CD153 ..... 625

CD154 ..... 625

CD155 ..... 622

CD156 ..... 633

CD15704 ..... 631

CD158 ..... 624

CD159 ..... 624

CD16005 ..... 631

CD165 ..... 335, 336

CD166 ..... 335, 337

CD167 ..... 38

CD170 ..... 622

CD171 ..... 392

CD171 ..... 624

**C**

CD172	394, 490, 491
CD173	632
CD174	632
CD175	632
CD176	632
CD177	632
CD178	395, 422, 423, 454
CD179	395, 422, 423, 454
CD180	395, 422, 423, 454
CD181	395, 422, 423, 454
CD533	58, 59
CF505RGBW	632
CF505RGBW	638
CHASE	472
CHERA	554
CL100	357, 358
CL101	356, 360
CL10220	356, 357, 358, 359, 360, 361
CL10305	356, 360, 361
CL10305DA	356, 360, 361
CL10330	356, 360, 361
CL10330DA	356, 360, 361
CL10405	357, 358, 359
CL10430	357, 358, 359
CL10505	356, 357, 358, 359, 360, 361
CL10530	356, 357, 358, 359, 360, 361
CL10605	356, 357, 358, 359, 360, 361
CL10630	356, 357, 358, 359, 360, 361
CL10705	356, 357, 358, 359, 360, 361

**C**

CL10730	356, 357, 358, 359, 360, 361
CL108	359
CL109	361
CL11005	356, 360, 361
CL11030	356, 360, 361
CLAC	221
CLAC 1 MINI	220
CLAC 2 MINI	220
CLARA 1 RDX	98
CLARA 2 RDX	98, 99
CLIC RDX	104, 105
CLIC RDX MINI	104, 105
COMO RX GU10	31
COPE RD	67
COSTE 1	510, 511
COSTE 2	510
CR575RGBW	519, 521, 639
CR575RGBW	639
CUBIC P	465
CURLI 1 RD	126
CURLI 2 RD	127
CURLI 3 RD	127
CURTIS PLUS	574, 575
CURTIS SENSOR PLUS	574, 575
CYCLO	480, 481
CYCLO SENSOR	480, 481
<b>D</b>	
DANI	548, 549
DAX RD-230	118, 119
DEAN RDX PLUS	110
DEAN RX	110, 111
DEBI RD	52, 53
DEBI RD-230	52
DEVI	496
DLCONVERT70BS	50, 51
DLCONVERT70CR	50, 51
DLCONVERT70MW	50, 51
DLCONVERT70WH	50, 51
DLCVT110BLK	50, 51
DLCVT110BS	50, 51
DLCVT110MW	50, 51
DLCVT110WH	50, 51
DLK2072	28
DLK2072 RX GU10	28
DM	148
DMCSP	148, 149
DO102	124, 125
DO103	42
DO104	42, 43
DO107	136, 137
DO108	80
DO109	80, 81
DO115	60
DO160	60
DO164	64
DO165	64, 65
DO171	72
DO182	61
DO197	34, 35
DO212	35

**D**

DO221	73
DO224	104, 105
DO225	221
DO227	61
DO241	39
DO246	108
DO263	224, 225
DO272	78
DO287	126
DO288	127
DO289	127
DO315	45
DO330	72
DO33305	26, 27, 60, 68, 69, 70, 71
DO33330	26, 27, 60, 68, 69, 70, 71
DO334	38
DO337	40
DO33805	40
DO33821	40
DO33830	40
DO33905	73
DO33930	73
DO34005	73
DO34030	73
DO344	138
DO346	140
DO356	120
DO357	120
DO358	120, 121
DO361	57
DO365	104, 105
DO366	114, 115
DO377	84
DO378	84
DO379	86
DO380	86
DO385	88
DO386	88
DO389	85
DO390	85
DO391	85
DO392	87
DO393	87
DO394	87
DO401	89
DO402	89
DO403	89
DO407	90, 91
DO408	90, 91
DO409	90, 91
DO42030	126
DO42130	127
DO42230	127
DO430	52, 53
DO431	54
DO440	57
DO442	62
DO443	62, 63
DO444	96
DO445	52
DO446	54, 55
DO448	68, 69
DO459	44
DO460	44
DO461	74
DO462	75
DO464	75
DO465	67

**D**

DO466	67
DO467	66
DO468	38
DO469	76
DO470	77
DO471	77
DO475	26, 27
DO476	26, 27
DO48025	76
DO48060	76
DO48125	77
DO48160	77
DO48225	77
DO48260	77
DO487	118, 119
DO488	138, 139
DO489	140, 141
DO490	109
DO491	97
DO495	114, 115
DO496	82, 83
DO497	82, 83
DO498	82, 83
DO499	82, 83
DO500	82, 83
DO501	70
DO502	71
DO507	100, 101
DO508	102, 103
DO509	106
DO510	107
DO511	110, 111
DO512	94, 95
DO513	30
DO514	30
DO515	95
DO518	31
DO526	110
DO527	100, 101
DO528	102, 103
DO529	79
DO530	79
DO531	134
DO532	134, 135
DO533	58, 59
DO534	98
DO535	98, 99
DO536	118, 119
DO537	56
DO538	130
DO539	131
DO540	132
DO541	133
DO542	112
DO543	112, 113
DO544	48
DO545	49
DO546	24, 25
DO547	24
DO54804	138, 139
DO54805	138, 139
DO549	46
DO550	46, 47
DOMINO	148
DOMINO CSP	148, 149
DOTS	82, 83

**D**

DOTS C	211
DUCA	86
DUCA POWER	87
DW110R	154, 155
DW110S	154
DW1120R	206
DW1120S	206, 207

**E**

EAZY	384, 385
EDDY RX	106
EDGY	540
ELBY R	508, 509
ELBY S	508, 509
ELLA	178, 179
ELNE 1	462, 463
ELNE 2	462
ELNE 4	462, 463
EPI RD	67
EVA 62 R	206
EVA 62 S	206, 207
EVA 65R	154, 155
EVA 65S	154
EVIA G9	160

**F**

FARO 1	568
FARO 2	568, 569
FIJI R GU10	30
FILI 1 RX GU10 AUTO	96
FILI 1 RX-B	108
FILI 4 RX	216, 217
FILI 5 RDX-B	109
FILI 5 RX-B GU10 AUTO	97
FILO P	477
FINN P	469
FINN W	515
FL100	577
FL101	578, 579
FL102	576, 577
FL103	578
FOCAL	322
FOCEA 1 SX PLUS	140, 141
FOCEA 2 SX	140
FOCUS	323
FOLD 1	186
FOLD 2	186
FOX 2 RD	124, 125
FULLA	176, 177
FURY S GU10	502

**G**

GARI	84
GARI POWER	85
GH220B	448, 449, 450, 451, 452, 453, 522
GH220D	448, 449, 450, 451, 453, 522

**G**

GH220Z	448, 449, 450, 451, 452, 453, 522
GL008 RGBW	424, 425
GL008RGBW	424, 425
GL016	413
GL016 F	415
GL016 RGBW	428
GL016 SQ	414
GL016F	415
GL016RGBW	428
GL016SQ	414
GL018 C	422
GL018 SQ	423
GL018C	422
GL018SQ	423
GL019	409
GL019 E	488
GL019 F	411
GL019 LG	410
GL019 SQ	412
GL019 ULG	410
GL019E	488
GL019F	411
GL019LG	410
GL019SQ	412
GL019ULG	410
GL021	486
GL022	487
GL034	489
GL038	408
GL040	406
GL040 CA RGB	427
GL040 ULG	407
GL040CARGB	427
GL040ULG	407
GL045	405
GL050	420, 421
GL050 RGBW	429
GL050RGBW	429
GL06	405
GL063	416
GL064	417
GL07	404
GL08	403
GL09	402, 403
GL090 RGBW	426
GL090RGBW	426
GL100	418
GL200	419
GLA01	406, 407, 420, 421, 426, 427, 429
GLAM 164	178
GLAM 250	182, 183
GLAM 265	180, 181
GLAM 90	180, 181
GS220B	448, 449, 450, 451, 452, 453, 522



**G**

GS220D .....	448,
	449,
	450,
	451,
	453,
	522
GS220Z .....	448,
	449,
	450,
	451,
	452,
	453,
	522
GUNZY .....	442
GUNZY 2 P .....	443
GUNZY 2 S .....	524
GUNZY P .....	442
GUNZY S .....	524
GYRO .....	398
GYRO A .....	399

**H**

H2 LITE CSP .....	51
H2 LITE SELECT .....	50
H2LC .....	51
H2LS .....	50
HALO .....	313
HAPPY 1 .....	208
HAPPY 2 .....	209
HAPPY 3 .....	210
HARRY A .....	533
HB100 .....	381
HB101 .....	382
HB102 .....	383
HB103 .....	381,
	382,
	383
HB104 .....	381,
	382,
	383,
	384,
	385
HB105 .....	381
HB106 .....	382
HB107 .....	383
HB108 .....	384,
	385
HB110 .....	384,
	385
HB111 .....	384,
	385
HB112 .....	384,
	385
HB113 .....	384,
	385
HB114 .....	384,
	385
HB115 .....	381,
	382,
	383,
	384,
	385
HBASDH SRC .....	380
HD1050 .....	32, 33
HD1050 R GU10 .....	32, 33
HD1070 .....	32, 33
HD1070 R GU5.3 .....	32, 33
HEDI .....	184,
	185
HELLO 1 D .....	314
HELLO 1 P .....	246
HELLO 2 D .....	314,
	315
HELLO 2 P .....	246,
	247
HUGO GU10 .....	503

**I**

IENA RDX .....	54
IENA RDX-230 .....	54, 55
ILY .....	560,
	561
INDY 1 .....	577
INDY 1 A .....	576,
	577

**I**

INDY 2 .....	578,
	579
INDY 2 A .....	578
IPHO 82 RD .....	64
IPHO 82 SD .....	64, 65
IPHO R GU10 AUTO .....	34, 35
IPHO S GU10 AUTO .....	35
IRO 1 .....	352,
	353
IRO 2 .....	352
ITO .....	512
IZA 1 SDX .....	134
IZA 2 SDX .....	134,
	135

**J**

JACK 3 P .....	245
JACK 3 T .....	324
JACK 3 TP .....	325
JACK T .....	298
JACK TP .....	299
JADE RDX .....	78
JB1 .....	422,
	423,
	454
JB1 .....	642
JB2 .....	406,
	407,
	409,
	410,
	411,
	412,
	413,
	414,
	415,
	416,
	417,
	418,
	420,
	421,
	446,
	447,
	448,
	450,
	452,
	455,
	486,
	487,
	488,
	518,
	520
JB2 .....	643
JB3 .....	592,
	593
JB3 .....	643
JB4 .....	406,
	407,
	409,
	410,
	411,
	412,
	413,
	414,
	415,
	416,
	417,
	418,
	420,
	446,
	447,
	448,
	450,
	452,
	455,
	486,
	487,
	488,
	518,
	520
JB4 .....	644

**J**

JB5 .....	402,
	403,
	404,
	405,
	408,
	419,
	422,
	423,
	449,
	451,
	453,
	454,
	479,
	489,
	492,
	493
JB5 .....	644
JB6 .....	406,
	407,
	409,
	410,
	411,
	412,
	413,
	414,
	415,
	416,
	417,
	418,
	420,
	421,
	422,
	423,
	446,
	447,
	448,
	450,
	452,
	454,
	455,
	486,
	487,
	488,
	518,
	520
JB6 .....	645
JB7 .....	424,
	425,
	426,
	427,
	428,
	429,
	519,
	521
JB7 .....	645
JIMY 2 .....	312
JOY RX .....	107
JUNE 1 C .....	226
JUNE 1 P .....	248
JUNE 2 C .....	227
JUNE 2 P .....	249
JUNE 3 C .....	227
JUNE 3 P .....	249

**K**

KACI R-B .....	41
KADRO E27 .....	504
KALA .....	600,
	601
KALI R-230 B .....	40
KARL 1 RDX .....	112
KARL 2 RDX .....	112,
	113
KARO 1 .....	338
KARO 2 .....	338,
	339
KARO 3 .....	338,
	339
KASA R GU10 .....	24, 25
KASA RX GU10 .....	24
KAVA .....	176,
	177
KC211R .....	41
KIT ÉCLAIRAGE SECOURS .....	634
KO 703R .....	152,
	153
KO 703S .....	152,
	153

**K**

KO2000 R .....	390
KO2000 R GU10 .....	390
KO2000 S .....	390
KO2000 S GU10 .....	390
KO703R .....	152,
	153
KO703S .....	152,
	153
KO91 .....	392
KOPA .....	546,
	547
KORY R .....	46
KORY R SENSOR .....	46, 47
KOS 1 S .....	544
KOS 2 R .....	544,
	545
KOS 2 S .....	544
KS1800 .....	28, 29
KS1800 RX GU10 AUTO .....	28, 29
KSA 1002 R GU10 AUTO .....	22, 23
KSA 1012 RX GU10 AUTO .....	23
KSA1002 .....	22, 23
KSA1012 .....	23
KU1479 .....	176,
	177
KUBO .....	546,
	547

**L**

LANTERN .....	541
LARY RD .....	62
LARY SD .....	62, 63
LASY RX .....	38
LB .....	380
LBACM .....	380
LBAL5090 .....	380
LBASDHS .....	380
LED9W500DWW .....	618
LEDEP10 .....	122,
	123,
	128,
	129,
	144,
	145,
	146,
	147,
	148,
	149
LEDEP10 .....	634
LEDRGBWEXT .....	553
LEGA D .....	347
LENA .....	88
LENA POWER .....	89
LENTUS .....	380
LEWIS .....	560,
	561
LIDY .....	368,
	369
LIDY A .....	370
LIDY A SENSOR .....	370,
	371
LIDY SENSOR .....	368
LIKA .....	156
LIKI .....	610,
	611
LIMA 1 PLUS .....	326,
	327
LIMA 2 PLUS .....	328
LIMA 3 PLUS .....	329
LINEA 1 .....	330,
	331
LINEA 2 .....	330,
	331
LINEAR 1 C .....	357,
	358
LINEAR 1 P .....	356,
	360
LINEAR 2 C .....	359
LINEAR 2 P .....	361
LISY RD .....	44
LISY RDX .....	44
LONGA .....	190,
	191

**L**

LOOP 1 .....	340,
	341
LOOP 2 .....	340,
	341
LP533 .....	58, 59
LP53305 .....	58, 59
LP53321 .....	58, 59
LP53330 .....	58, 59
LUPO 1 .....	212
LUPO 1 GU10 .....	196,
	197
LUPO 2 .....	213
LUXI 100 S .....	526
LUXI 100 S P .....	472
LUXI 120 R .....	506
LUXI 120 S .....	507
LUXI 139 .....	535
LUXI 175 SENSOR .....	538
LUXI 175 SENSOR P .....	478
LUXI 180 .....	467
LUXI 190 .....	554
LUXI 193 .....	497
LUXI 290 .....	554,
	555
LUXI 45 .....	536,
	537
LUXI 45 SENSOR .....	536,
	537
LUXI 54 .....	464
LUXI 65 GU10 .....	432,
	433
LUXI 650 .....	471
LUXI 80 .....	479
LUXI 95 .....	551
LUZ 1 .....	566
LUZ 2 .....	567
LYON 1 R .....	130
LYON 2 R .....	131
LYON 3 R .....	132
LYON 4 R .....	133

**M**

MAKA .....	157
MALTA 1 .....	187
MALTA 2 .....	187
MANYL 1 .....	214
MANYL 2 .....	214,
	215
MANYL 2 GU10 .....	196,
	197
MARY RDX-230 .....	45
MC010 S .....	542
MC010S .....	542
MC020 S .....	542
MC020S .....	542
MF02 IP .....	516,
	517
MF02IP .....	516,
	517
MILO 1 .....	170,
	171
MILO 2 .....	170,
	171
MILO 3 .....	172,
	173
MILO 4 .....	173
MINI 6 .....	392
MINI SHADE .....	606,
	607
MINI TIMY .....	365
MINI TIMY E27 .....	364
MINI TIMY SENSOR .....	365
MINI TIMY SENSOR E27 .....	364
MINI VARA .....	608
MINO P E27 .....	458,
	459
MINO W E27 .....	505
ML01 .....	484
ML02 .....	484,
	485
MODU LED .....	618
MOLY GU10 .....	202

**M**

MOON .....	604,
	605
MOWI RD .....	66

**N**

NOLY GU10 .....	203
NORA .....	550
NOVA CSP 1 C .....	228
NOVA CSP 1 P .....	250
NOVA CSP 2 C .....	228
NOVA CSP 2 P .....	250
NOVA CSP 3 C .....	229
NOVA CSP 3 P .....	251
NV45 .....	228
NV45UPM .....	228,
	250
NV60 .....	228
NV60UPM .....	228,
	250
NV90 .....	229
NV90UPM .....	229,
	251

**O**

OKTO GU10 .....	198,
	199
OKTO 1 C GU10 .....	200
OKTO 2 GU10 .....	162,
	163
OKTO 2 C GU10 .....	200
OKTO 3 T GU10 .....	308
OKTO 3 TP GU10 .....	309
OKTO 4 C GU10 .....	201
OKTO C GU10 .....	198
OKTO P GU10 .....	240,
	241
OKTO RX GU10 .....	95
OKTO T GU10 .....	296
OKTO TP GU10 .....	297
OLA 1 .....	434,
	435
OLA 2 .....	473
ONEO A .....	532
ONEX .....	350
OPAL .....	539
ORKI .....	373
ORKI SENSOR .....	373
OSIS 1 .....	316,
	317
OSIS 1 PLUS .....	317
OSIS 2 .....	318,
	319
OSIS 2 PLUS .....	318
OTIS 2 P .....	260,
	261
OU105 .....	554
OU106 .....	554,
	555
OU108 .....	432,
	433
OU125 .....	394
OU135 .....	535
OU136 .....	464
OU138 .....	471
OU139 .....	367
OU143 .....	526
OU144 .....	551
OU145 .....	506
OU146 .....	507
OU150 .....	548,
	549
OU154 .....	490
OU158 .....	490,
	491
OU161 .....	394
OU168 .....	393
OU17505 .....	574,
	575
OU177 .....	477
OU178 .....	477
OU185 .....	524
OU186 .....	524
OU187 .....	442

**O**

OU190 ..... 494  
 OU204 ..... 497  
 OU206 ..... 536,  
 537  
 OU253 ..... 504  
 OU261 ..... 393  
 OU263 ..... 396  
 OU271 ..... 391  
 OU277 ..... 533  
 OU279 ..... 564  
 OU281 ..... 564  
 OU282 ..... 565  
 OU310 ..... 502  
 OU316 ..... 465  
 OU318 ..... 467  
 OU323 ..... 538  
 OU324 ..... 479  
 OU325 ..... 479  
 OU326 ..... 397  
 OU328 ..... 586,  
 587  
 OU334 ..... 546,  
 547  
 OU336 ..... 474,  
 475  
 OU340 ..... 512  
 OU342 ..... 600,  
 601  
 OU344 ..... 541  
 OU345 ..... 440  
 OU346 ..... 440,  
 441  
 OU347 ..... 609  
 OU348 ..... 598,  
 599  
 OU350 ..... 496  
 OU353 ..... 466  
 OU354 ..... 468  
 OU355 ..... 606,  
 607  
 OU356 ..... 472  
 OU357 ..... 470  
 OU358 ..... 470  
 OU359 ..... 536,  
 537  
 OU360 ..... 527  
 OU361 ..... 474,  
 475  
 OU362 ..... 474,  
 475  
 OU363 ..... 554  
 OU364 ..... 508,  
 509  
 OU365 ..... 508,  
 509  
 OU367 ..... 478  
 OU374 ..... 495  
 OU375 ..... 525  
 OU387 ..... 543  
 OU390 ..... 480,  
 481  
 OU391 ..... 480,  
 481  
 OU39224 ..... 480,  
 481  
 OU395 ..... 365  
 OU396 ..... 365  
 OU397 ..... 373  
 OU399 ..... 610,  
 611  
 OU400 ..... 458,  
 459  
 OU401 ..... 458,  
 459  
 OU402 ..... 458,  
 459  
 OU403 ..... 458,  
 459  
 OU404 ..... 458,  
 459  
 OU405 ..... 458,  
 459  
 OU407 ..... 505  
 OU408 ..... 505

**O**

OU409 ..... 505  
 OU410 ..... 514  
 OU411 ..... 397  
 OU412 ..... 600,  
 601  
 OU413 ..... 460  
 OU414 ..... 460,  
 461  
 OU415 ..... 476  
 OU417 ..... 373  
 OU418 ..... 596,  
 597  
 OU42024 ..... 608,  
 609,  
 610,  
 611  
 OU42030 ..... 608,  
 610,  
 611  
 OU42124 ..... 608,  
 609,  
 610,  
 611  
 OU42130 ..... 608,  
 610,  
 611  
 OU422 ..... 608  
 OU42304 ..... 604,  
 605,  
 606,  
 607,  
 608,  
 609,  
 610,  
 611  
 OU424 ..... 560,  
 561  
 OU425 ..... 398  
 OU426 ..... 399  
 OU427 ..... 400,  
 401  
 OU428 ..... 400,  
 401  
 OU431 ..... 543  
 OU433 ..... 458,  
 459  
 OU434 ..... 505  
 OU435 ..... 596,  
 597  
 OU436 ..... 433  
 OU438 ..... 546,  
 547  
 OU43924 ..... 546,  
 547  
 OU440 ..... 570  
 OU441 ..... 571  
 OU445 ..... 364  
 OU445 ..... 596,  
 597,  
 598,  
 599,  
 600,  
 601  
 OU446 ..... 364  
 OU446 ..... 596,  
 597  
 OU447 ..... 568  
 OU448 ..... 568,  
 569  
 OU450 ..... 462,  
 463  
 OU451 ..... 462  
 OU452 ..... 462,  
 463  
 OU453 ..... 532  
 OU454 ..... 612  
 OU45524 ..... 612,  
 613  
 OU45547 ..... 612,  
 613  
 OU456 ..... 613  
 OU457 ..... 443  
 OU458 ..... 442  
 OU459 ..... 562  
 OU460 ..... 563  
 OU461 ..... 438,  
 439

**O**

OU46224 ..... 438,  
 439  
 OU463 ..... 476  
 OU464 ..... 598,  
 599  
 OU465 ..... 445  
 OU466 ..... 445  
 OU467 ..... 540  
 OU468 ..... 596,  
 597,  
 598,  
 599,  
 600,  
 601  
 OU469 ..... 596,  
 597  
 OU470 ..... 574,  
 575  
 OU471 ..... 574,  
 575  
 OU472 ..... 574,  
 575  
 OU473 ..... 574,  
 575  
 OU474 ..... 574,  
 575  
 OU475 ..... 574,  
 575  
 OU476 ..... 574,  
 575  
 OU477 ..... 544  
 OU478 ..... 544  
 OU479 ..... 544,  
 545  
 OU480 ..... 472  
 OU481 ..... 473  
 OU482 ..... 434,  
 435  
 OU483 ..... 434,  
 435  
 OU48405 ..... 432,  
 433,  
 434,  
 435,  
 436,  
 437,  
 438,  
 439,  
 440,  
 441,  
 442,  
 443,  
 574,  
 575,  
 576,  
 577,  
 578,  
 579  
 OU48505 ..... 432,  
 433,  
 434,  
 435,  
 436,  
 437,  
 438,  
 439,  
 440,  
 441,  
 442,  
 443,  
 574,  
 575,  
 576,  
 577,  
 578,  
 579  
 OU486 ..... 395  
 OU488 ..... 395  
 OU489 ..... 566  
 OU490 ..... 567  
 OU492 ..... 550  
 OU493 ..... 539  
 OU495 ..... 548,  
 549  
 OU497 ..... 444  
 OU498 ..... 588  
 OU499 ..... 588,  
 589

**O**

OU501 ..... 533  
 OU502 ..... 515  
 OU503 ..... 469  
 OU504 ..... 558,  
 559  
 OU505 ..... 558  
 OU507 ..... 471  
 OU508 ..... 500  
 OU509 ..... 500  
 OU510 ..... 501  
 OU511 ..... 501  
 OU512 ..... 560,  
 561  
 OU513 ..... 510,  
 511  
 OU514 ..... 510  
 OU515 ..... 480,  
 481  
 OU516 ..... 480,  
 481  
 OU517 ..... 436  
 OU518 ..... 436  
 OU519 ..... 437

**P**

P1SK ..... 144,  
 145  
 P1SKC ..... 145  
 P2A ..... 144  
 P2B ..... 145  
 P2C ..... 145  
 P2SMA ..... 144,  
 146,  
 147  
 P2SMB ..... 145  
 P2SMC ..... 145  
 PARA ..... 596,  
 597  
 PARO 1 ..... 342,  
 343  
 PARO 2 ..... 344  
 PARO 3 ..... 345  
 PIXA 1 ..... 222  
 PIXA 2 ..... 222  
 PIXA 3 ..... 223  
 PK1 ..... 188,  
 189  
 PK2 ..... 188,  
 189  
 PK30/1A/4K/W ..... 188,  
 189  
 PK30/2A/4K/W ..... 188,  
 189  
 PK60/1A/3K/W ..... 188,  
 189  
 PK60/1A/4K/W ..... 188,  
 189  
 PK60/2A/3K/W ..... 188,  
 189  
 PK60/2A/4K/W ..... 188,  
 189  
 PLANK 1 ..... 188,  
 189  
 PLANK 2 ..... 188,  
 189  
 PLR35015 ..... 484,  
 485,  
 486,  
 487,  
 516,  
 517,  
 542  
 PLU35019 ..... 484,  
 485,  
 486,  
 487,  
 516,  
 517,  
 542  
 POL ..... 376,  
 377  
 POL112N ..... 376,  
 377  
 POL115N ..... 376,  
 377  
 POL212N ..... 376,  
 377

**P**

POL215N ..... 376,  
 377  
 POLARIS ..... 376,  
 377  
 POLO ..... 548,  
 549  
 PR115 ..... 280  
 PR11630 ..... 280  
 PR11652 ..... 280  
 PR117 ..... 282  
 PR11830 ..... 282  
 PR11852 ..... 282  
 PR11952 ..... 281,  
 282  
 PR12052 ..... 281,  
 282  
 PR121 ..... 283  
 PR12230 ..... 283  
 PR12252 ..... 283  
 PR12330 ..... 283  
 PR12352 ..... 283  
 PR12452 ..... 283  
 PR127 ..... 284  
 PR12830 ..... 284  
 PR12852 ..... 284  
 PR12952 ..... 284  
 PR130 ..... 285  
 PR13130 ..... 285  
 PR13152 ..... 285  
 PR13252 ..... 285  
 PR133 ..... 287  
 PR13430 ..... 287  
 PR13452 ..... 287  
 PR135 ..... 288  
 PR13630 ..... 288  
 PR13652 ..... 288  
 PR137 ..... 289  
 PR13830 ..... 289  
 PR13852 ..... 289  
 PR139 ..... 281  
 PR14052 ..... 280  
 PR14152 ..... 281,  
 282  
 PR14252 ..... 283  
 PR14352 ..... 287,  
 288  
 PR14452 ..... 289  
 PR14530 ..... 281  
 PR14552 ..... 281  
 PR146 ..... 286  
 PR14752 ..... 286  
 PR3011 ..... 424,  
 425,  
 426,  
 427,  
 428,  
 429,  
 519,  
 521,  
 553,  
 592,  
 593  
 PRO14 ..... 580  
 PRO14/F/3K/A ..... 580  
 PRO14/F/3K/W ..... 580  
 PRO32 ..... 581  
 PRO32/AS/3K/G ..... 581  
 PRO32/AS/3K/W ..... 581  
 PRO32/M/3K/A ..... 581  
 PRO32/M/3K/G ..... 581  
 PRO32A ..... 581  
 PRO50 ..... 582  
 PRO50/AS/3K/A ..... 582,  
 583  
 PRO50/AS/3K/G ..... 582,  
 583  
 PRO50/M/3K/G ..... 582  
 PRO50/M/3K/W ..... 582  
 PRO50A ..... 582,  
 583  
 PS250600MA ..... 122,  
 123

**P**

PS6501100MA ..... 144,  
 145,  
 146,  
 148  
 PSDAL700M ..... 136,  
 137  
 PSIP35018W ..... 406,  
 407,  
 409,  
 410,  
 411,  
 412,  
 413,  
 414,  
 415,  
 416,  
 417,  
 418,  
 420,  
 421,  
 446,  
 447,  
 448,  
 450,  
 452,  
 484,  
 485,  
 486,  
 487,  
 488,  
 516,  
 517,  
 542  
 PSIP3509W ..... 406,  
 407,  
 409,  
 410,  
 411,  
 412,  
 413,  
 414,  
 415,  
 416,  
 417,  
 418,  
 420,  
 421,  
 446,  
 447,  
 448,  
 450,  
 452,  
 484,  
 485,  
 486,  
 487,  
 488,  
 516,  
 517,  
 542  
 PSIP70018W ..... 406,  
 409,  
 412,  
 413,  
 414,  
 418,  
 446,  
 447,  
 448,  
 450,  
 452,  
 455,  
 488,  
 518,  
 520  
 PSIP70036W ..... 406,  
 409,  
 412,  
 413,  
 414,  
 418,  
 446,  
 447,  
 448,  
 450,  
 452,  
 455,  
 488,  
 518,  
 520  
 PU637WW ..... 396

**P**

PURE 190 ..... 494  
 PURE 380 ..... 396  
 PURE 45 ..... 394  
 PURE 55 ..... 394

**R**

RAMA P ..... 598, 599  
 RAMA W ..... 598, 599  
 RAVEL ..... 468  
 RAY ..... 300, 301  
 RAYPRO 14 ..... 580  
 RAYPRO 32 ..... 581  
 RAYPRO 32 A ..... 581  
 RAYPRO 50 ..... 582  
 RAYPRO 50 A ..... 582, 583  
 RB359BLK ..... 50, 51  
 RB359BS ..... 50, 51  
 RB359CR ..... 50, 51  
 RB359MW ..... 50, 51  
 RB359PG ..... 50, 51  
 RB359SIL ..... 50, 51  
 RB359WH ..... 50, 51  
 RC2819 ..... 632  
 RIESA ..... 438, 439  
 RIVA 2 GU10 ..... 204  
 RIVA 3 GU10 ..... 204  
 RIVA 4 GU10 ..... 205  
 RODA C ..... 234, 235  
 RODA P ..... 256, 257  
 RODI A ..... 400, 401  
 ROMY R GU10 ..... 558, 559  
 ROMY S GU10 ..... 558  
 RONDO P E27 ..... 458, 459  
 RONDO W E27 ..... 505  
 RONGA 1 RDX-B ..... 76  
 RONGA 2 RDX-B ..... 77  
 RONGA 3 RDX-B ..... 77

**S**

SENSO R-230 ..... 118, 119  
 SETO ..... 474, 475  
 SILK RDX ..... 70  
 SILK RDX WARM ..... 71  
 SIRA R ..... 114, 115  
 SIRA R SENSOR IR ..... 114, 115  
 SKIP ..... 564  
 SKIP 2 ..... 565  
 SKIP 4 ..... 564  
 SL030 ..... 446, 447  
 SL040A ..... 455  
 SL220 ..... 448  
 SL220 MAINS ..... 449  
 SL220M ..... 449  
 SL230 ..... 450  
 SL230 MAINS ..... 451  
 SL230M ..... 451  
 SL240 ..... 452  
 SL240 MAINS ..... 453  
 SL240M ..... 453  
 SL250 ..... 454  
 SL250A1 ..... 454  
 SLIT R ..... 490  
 SLIT S ..... 490, 491  
 SNOOP ..... 164, 165  
 SNOOP GU10 ..... 164  
 SOLIP ..... 146

**S**

SOLIS 1 ..... 144  
 SOLIS 2 ..... 145  
 SOLIS 3 ..... 145  
 SOLIS IP65 ..... 146  
 SOLIS PRO ..... 146  
 SOLIS PRO CSP ..... 147  
 SOLP ..... 146  
 SOLPCSP ..... 147  
 SORA POWER ..... 90, 91  
 SPIRA 1 RX PLUS ..... 138, 139  
 SPIRA 3 RX ..... 138  
 SPOTI R-B ..... 39  
 SPRINGBOK LITE 1 ..... 381  
 SPRINGBOK LITE 2 ..... 382  
 SPRINGBOK LITE 3 ..... 383  
 SQB360BLK ..... 50, 51  
 SQB360MW ..... 50, 51  
 ST104 ..... 266, 267  
 ST112 ..... 271  
 ST118 ..... 271  
 ST119 ..... 271  
 ST120 ..... 271  
 ST121 ..... 271  
 ST122 ..... 271  
 ST123 ..... 273  
 ST125 ..... 275  
 ST126 ..... 275  
 ST127 ..... 275  
 ST128 ..... 275  
 ST129 ..... 275  
 ST130 ..... 275  
 ST132 ..... 274  
 ST135 ..... 278, 279  
 ST136 ..... 278, 279  
 ST137 ..... 278, 279  
 ST138 ..... 278, 279  
 ST139 ..... 278, 279  
 ST140 ..... 278, 279  
 ST141 ..... 278, 279  
 ST142 ..... 278, 279  
 ST143 ..... 278, 279  
 ST144 ..... 278, 279  
 ST145 ..... 278, 279  
 ST150 ..... 268  
 ST151 ..... 268, 269, 270  
 ST152 ..... 268, 269, 270  
 ST153 ..... 269  
 ST156 ..... 270  
 ST159 ..... 272  
 ST160 ..... 276, 277  
 ST161 ..... 276, 277  
 ST162 ..... 276, 277  
 STELLA ..... 466  
 SU138 ..... 242, 243  
 SU13976 ..... 242, 243  
 SU148 ..... 256, 257  
 SU149 ..... 256, 257  
 SU153 ..... 252  
 SU154 ..... 252  
 SU155 ..... 253

**S**

SU156 ..... 248  
 SU157 ..... 249  
 SU158 ..... 258, 259  
 SU159 ..... 258  
 SU160 ..... 240, 241  
 SU161 ..... 245  
 SU163 ..... 249  
 SU164 ..... 254  
 SU165 ..... 254, 255  
 SU166 ..... 246  
 SU167 ..... 246, 247  
 SU168 ..... 260, 261  
 SU169 ..... 244  
 SU170 ..... 250  
 SU171 ..... 250  
 SU172 ..... 251  
 SULLY C ..... 234, 235  
 SULLY P ..... 256, 257  
 SUNY 1 ..... 612  
 SUNY 2 ..... 613  
 SUP 08 AUTO ..... 619  
 SUP08 ..... 619  
 SWEET RD ..... 68, 69  
 SWIM ..... 395  
 SYLA RD-B ..... 73

**T**

TED ..... 320, 321  
 THEA LITE CSP 1 ..... 122  
 THEA LITE CSP 2 ..... 123  
 THEA LITE CSP 3 ..... 123  
 THEA PRO 1 ..... 128  
 THEA PRO 2 ..... 129  
 THL1 ..... 122  
 THL2 ..... 123  
 THL3 ..... 123  
 THP1 ..... 128  
 THP12UGR ..... 128  
 THP1DD ..... 128  
 THP2 ..... 129  
 THP23DD ..... 128, 129  
 THP34UGR ..... 129  
 THP4DD ..... 129  
 TIBLI R-B ..... 38  
 TIGA 1 RD ..... 120  
 TIGA 2 RD ..... 120  
 TIGA 3 RD ..... 120, 121  
 TIMY ..... 366  
 TIMY SENSOR ..... 367  
 TINY R ..... 393  
 TIPI RX ..... 42, 43  
 TIPI SX ..... 42  
 TIPO 1 C ..... 224, 225  
 TIPO 2 C ..... 225  
 TOMY 1 C ..... 236, 237  
 TOMY 1 P ..... 258, 259  
 TOMY 2 P ..... 258  
 TP1139 ..... 366  
 TR131 ..... 312  
 TR152 ..... 313  
 TR153 ..... 313  
 TR220 ..... 304, 305  
 TR221 ..... 304, 305  
 TR222 ..... 304, 305  
 TR22330 ..... 304, 305

**T**

TR22331	304, 305
TR22430	304, 305
TR22431	304, 305
TR22530	304, 305
TR22531	304, 305
TR22630	304, 305
TR22631	304, 305
TR22730	304, 305
TR22731	304, 305
TR22830	304, 305
TR22831	304, 305
TR22930	304, 305
TR22931	304, 305
TR23030	304, 305
TR23031	304, 305
TR23130	304, 305
TR23131	304, 305
TR23230	304, 305
TR23231	304, 305
TR23330	304, 305
TR23331	304, 305
TR23430	304, 305
TR23431	304, 305
TR23530	304, 305
TR23531	304, 305
TR23630	304, 305
TR23631	304, 305
TR23730	304, 305
TR23731	304, 305
TR23830	304, 305
TR23831	304, 305
TR23930	304, 305
TR23931	304, 305
TR240	334
TR24030	304, 305
TR24031	304, 305
TR241	334
TR24130	304, 305, 306, 307, 308, 310, 312, 313, 323, 324, 326, 327, 328, 329

**T**

TR24131	304, 305, 306, 307, 308, 310, 312, 313, 323, 324, 326, 327, 328, 329
TR242	334
TR24305	334
TR24405	334
TR24505	334
TR24605	334, 336
TR24705	334, 336
TR24805	334, 336
TR24905	334, 336
TR25005	335, 336
TR25105	335
TR25205	335
TR25305	335
TR25405	335
TR25505	335, 337
TR260	336
TR261	336
TR262	336
TR26305	336
TR26405	336
TR26505	336
TR267	346
TR268	346
TR270	350, 351
TR271	350, 351
TR272	350, 351
TR279	348, 349
TR280	348, 349
TR28000677	145
TR281	348, 349
TR2818	632
TR283	350
TR284	342, 343
TR285	342, 343
TR286	342, 343
TR287	344
TR288	344
TR289	344
TR29005	344
TR29105	344
TR29337	344
TR29437	344
TR29537	344
TR29605	344
TR299	345
TR300	345
TR30105	345
TR30205	345
TR30337	345
TR30437	345
TR30537	345
TR30605	345
TR311	352, 353
TR312	352

**T**

TR32105	326, 327
TR32205	328
TR32305	329
TR32432	326, 327
TR32532	328
TR32632	329
TR32756	326, 327
TR32856	328
TR32956	329
TR33058	326, 327
TR33158	328
TR33258	329
TR357	330, 331
TR358	330, 331
TR359	306, 307
TR360	338
TR36030	304, 305
TR36031	304, 305
TR361	338, 339
TR362	338, 339
TR364	347
TR36505	334
TR36605	334
TR36705	334
TR36805	334
TR370	316, 317
TR371	318, 319
TR37205	334
TR37305	334
TR37405	334
TR37505	335, 336
TR376	347
TR377	347
TR378	348, 349
TR379	348, 349
TR380	348, 349
TR381	348, 349
TR382	348, 349
TR383	348, 349
TR38505	326, 327
TR38530	326, 327
TR38605	328
TR38630	328
TR38705	329
TR38730	329
TR38805	330, 331
TR389	314
TR390	314, 315
TR391	340, 341
TR392	340, 341
TR393	323
TR394	323
TR395	326, 327
TR396	326, 327
TR397	328
TR398	328
TR399	329
TR400	329

**T**

TR401	292, 293
TR402	292, 293
TR40304	292, 293
TR40305	292, 293
TR40404	292, 293
TR40405	292, 293
TR40504	292, 293
TR40505	292, 293
TR40604	292, 293
TR40605	292, 293
TR40704	292, 293
TR40705	292, 293
TR40804	292, 293
TR40805	292, 293
TR40904	292, 293
TR40905	292, 293
TR41004	292, 293
TR41005	292, 293
TR41104	292, 293
TR41105	292, 293
TR41120	292, 293
TR41204	292, 293
TR41205	292, 293
TR41304	292, 293
TR41305	292, 293
TR41404	292, 293
TR41405	292, 293
TR41504	292, 293
TR41505	292, 293
TR418	300, 301
TR419	296
TR420	297
TR42104	292, 293
TR42105	292, 293
TR422	308
TR423	309
TR424	324
TR425	324
TR426	325
TR428	298
TR429	299
TR430	300, 301
TR431	294, 295
TR432	294
TR433	310
TR434	310, 311
TR435	320, 321
TR437	322
TR438	317
TR439	318
TR44004	292, 293

**T**

TR44005	292, 293
TR44104	292, 293
TR44105	292, 293
TR44204	292, 293
TR44205	292, 293
TR44304	292, 293
TR44305	292, 293
TR44404	292, 293
TR44405	292, 293
TRACK 48VDC RECESSED	336
TRACK 48VDC SURFACE	334
TRACK III SURFACE	304, 305
TRACK UNO	292, 293
TUBE332	409, 410, 411, 412, 418, 488
TUBE50	413, 414, 415, 428, 486, 487
TUBE68	406, 407, 416, 417, 419, 420, 421, 426, 427, 429
TULO E27	460, 461
TULO SENSOR E27	460
TURA GU10	433
<b>U</b>	
UL	592, 593
UL010	518
UL010 RGBW	519
UL010RGBW	519
UL030	520
UL030 RGBW	521
UL030RGBW	521
UL345CARGB	592, 593
UL346CARGB	592, 593
UL347CARGB	592, 593
ULCARGB	592, 593
UNIS R	562
UNIS S	563
<b>V</b>	
VARA	609
VIGO	350, 351
VITEL GX53	161
<b>W</b>	
WA110	180, 181
WA111	178
WA112	170, 171
WA128	184, 185
WA129	187
WA132	222
WA133	222
WA134	223

**W**

WA153	174
WA154	175
WA161	216, 217
WA164	187
WA165	170, 171
WA169	176, 177
WA170	184, 185
WA173	156
WA174	157
WA175	180, 181
WA176	182, 183
WA177	234, 235
WA178	234, 235
WA179	225
WA180	190, 191
WA181	190, 191
WA182	220
WA183	220
WA193	214
WA194	202
WA195	194
WA196	195
WA197	203
WA198	203
WA199	204
WA200	204
WA201	205
WA202	196, 197
WA203	196, 197
WA204	604, 605
WA20505	604, 605
WA20605	604, 605
WA20703	604, 605
WA20804	604, 605
WA209	176, 177
WA210	214, 215
WA211	212
WA212	213
WA215	172, 173
WA216	230
WA217	231
WA218	231
WA222	226
WA223	227
WA224	236, 237
WA229	198, 199
WA230	198
WA231	200
WA232	200
WA233	201
WA234	162, 163
WA235	173
WA236	186
WA237	186
WA238	208
WA239	209
WA240	210
WA241	227
WA242	232
WA243	232, 233

**W**

WA248 .....	211
WA249 .....	211
WA252 .....	178, 179
WA253 .....	161
WA254 .....	160
WA256 .....	218, 219
WA257 .....	219
WA258 .....	166, 167
WA259 .....	167
WA260 .....	168
WA261 .....	164
WA262 .....	164, 165
WA263 .....	168, 169
WALKER E27 .....	391
WALLY A .....	395
WBM01 .....	516, 517
WBM02 .....	516, 517
WC2820BLK .....	632
WC2820WH .....	632
WC59 .....	402, 403, 404, 405, 408, 419, 489, 492, 493
WC59 .....	642
WCR275BLACK .....	413, 414, 415, 416, 417, 420, 421, 446, 447, 454, 455, 486, 487, 518, 520
WCR275BLACK .....	638
WIDO .....	514
WL041 IP .....	513
WL041IP .....	513
WL060 .....	534
WL070 .....	552
WL070 RGBW .....	553
WL070RGBW .....	553
WL075 .....	523
WL220 MAINS .....	522
WL220M .....	522
WL340 .....	492
WL342 .....	492, 493
WL94 .....	372
<b>Y</b>	
YELY .....	600, 601
YERA GU10 .....	306, 307
YERA 1 T GU10 .....	294, 295
YERA 1 TP GU10 .....	294
YUKA .....	444
YUKO GU10 .....	203
<b>Z</b>	
ZEP 400 E27 .....	242, 243



## UTILISATION DU CATALOGUE



- |  |   |
|--|---|
| <ol style="list-style-type: none"> <li>1. CHAPITRE</li> <li>2. NOM DU PRODUIT</li> <li>3. PICTOGRAMMES<br/>(voir pages 650 - 651)</li> <li>4. DÉTAIL DU PRODUIT</li> <li>5. TYPE DE PRODUIT (A/B)</li> </ol> | <ol style="list-style-type: none"> <li>6. PHOTO DU PRODUIT</li> <li>7. SCHÉMA</li> <li>8. PRODUIT SIMILAIRE<br/>Indique le numéro de page d'un autre produit de la même gamme.</li> <li>9. AMBIANCE PRODUIT<br/>Photo du produit mis en situation.</li> </ol> |
|--|---|

[www.indigo-lighting.com](http://www.indigo-lighting.com)

ACCÉDEZ DIRECTEMENT À TOUS LES DOCUMENTS TECHNIQUES





Tous nos produits sont conformes aux normes européennes.

Toutes les fiches techniques sont téléchargeables sur notre site internet : [www.indigo-lighting.com](http://www.indigo-lighting.com)

Les renseignements repris dans ce catalogue sont informatifs. La société INDIGO LIGHTING se réserve le droit de modifier les caractéristiques de ses produits ou d'en arrêter la commercialisation sans préavis.

Les prix mentionnés sont indicatifs. Ils sont exprimés en **EUROS et s'entendent hors TVA** et hors taxes de recyclage. La société INDIGO LIGHTING se réserve le droit de les modifier à tout moment en cas de variation importante du coût des composants. Nos distributeurs sont avertis deux mois à l'avance d'une hausse éventuelle de prix. Les conditions générales de vente de la société INDIGO LIGHTING sont d'application.

Indigo Lighting se réserve le droit d'apporter, sans préavis, des modifications techniques à ses produits afin d'améliorer sa production. Descriptions, indications et coloris dans ce catalogue sont seulement indicatifs.

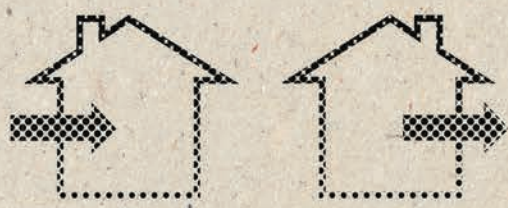

# INDIGO

---

## LIGHTING

**INDIGO S. A.**

Parc Artisanal de Cornemont  
Rue de la Légende 32G  
4141 Sprimont  
BELGIQUE

T : +32 (0)4 351 91 40  
F : +32 (0)4 351 91 41  
info@indigo-lighting.com

[indigo-lighting.com](http://indigo-lighting.com)



# INDIGO

LIGHTING

[indigo-lighting.com](http://indigo-lighting.com)

